

Catalogue 2025 | 2026

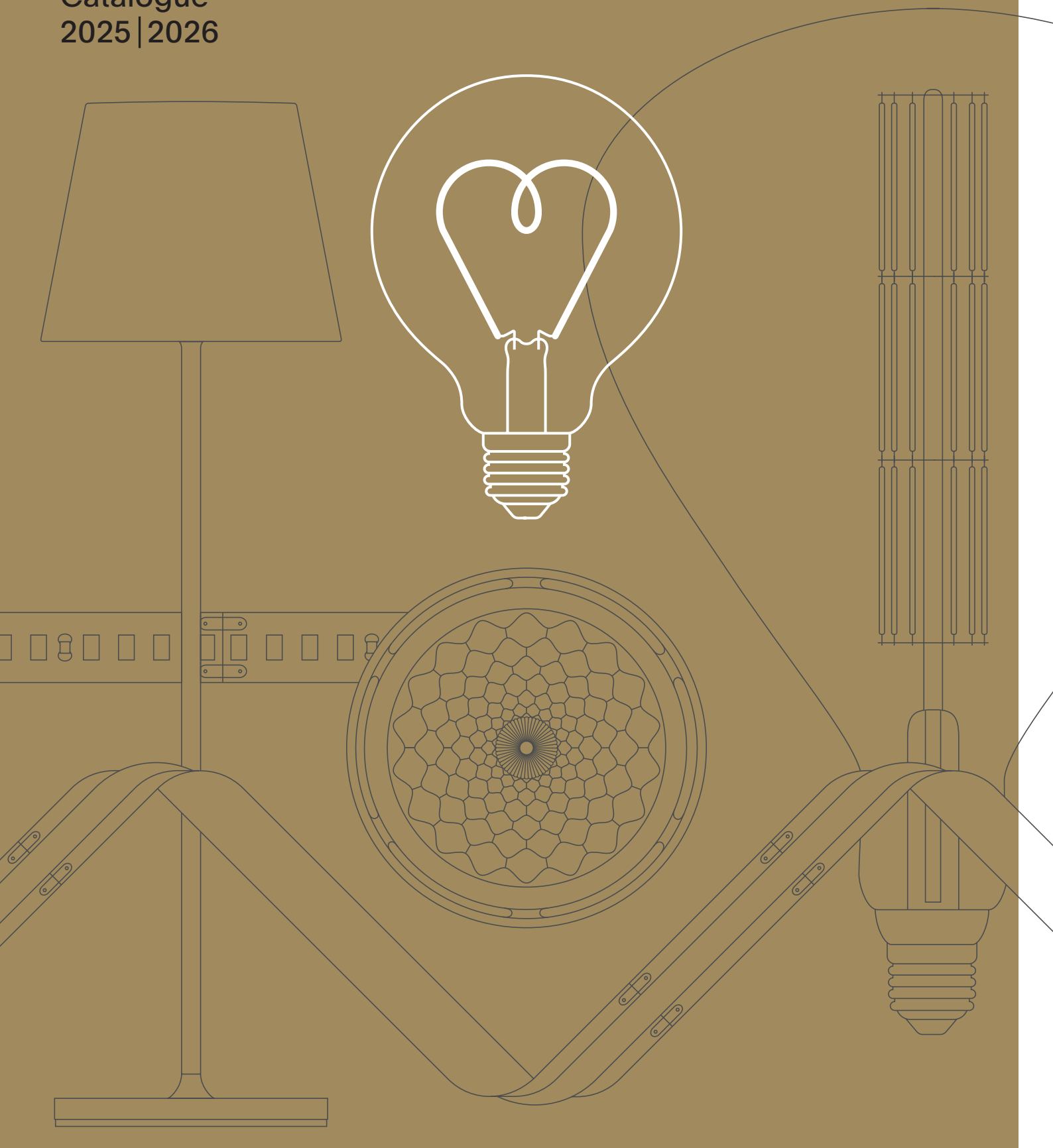

Orders

Phone +49 2339 1261-21

Fax +49 2339 1261-61

bestellung@sigor.de

Technical Sales

Phone +49 2339 1261-22

Online

www.shop.sigor.de

Returns Processing

Phone +49 2339 1261-38

reklamation@sigor.de

Accounting

Phone +49 2339 1261-24

Fax +49 2339 1261-67

buchhaltung@sigor.de

Business Hours

Monday – Thursday:

8 AM – 5 PM CET

Friday:

8 AM – 3 PM CET

SIGOR Licht GmbH

Eichenhofer Weg 81

42279 Wuppertal

Germany

Phone +49 2339 1261-0

info@sigor.de

www.sigor.de

WEEE Registration No.: DE 45242363



Photo: Christoph Meinschäfer Fotografie

“Quality means doing it right when no one is looking.”

Henry Ford



Dear customers,

we live in challenging times. The market is being flooded with cheap products from Asia, driven by overcapacities, uncertain trade policies, and growing consumer reluctance. In order to withstand these pricing pressures, even well-known manufacturers are increasingly offering lower-quality products that one would expect to find in discount stores rather than specialist retailers.

At SIGOR, we are consciously bucking this trend.

Our quality standards are not based on external control but on an internal attitude—regardless of whether anyone is watching or not. For this reason, we continue to focus on well-designed products, careful workmanship, and partnerships that share our values. A shining example of this is our collaboration with Bartenbach. This led to the creation of our Nivo® series, featuring a specially developed high-tech hybrid lens that precisely directs light through microfacets—for a pleasant, glare-free light with natural shadows. This year, Nivo® has already been used in several impressive projects.

This is what we are proud of! This is what drives us!

We thank you for your trust and hope you will enjoy exploring our new catalog—with exciting new products and lighting solutions that are sure to impress.

Kind regards
Michael Perterer
CEO of SIGOR Licht GmbH





Our Light Programme

Lamps
→ p. 8

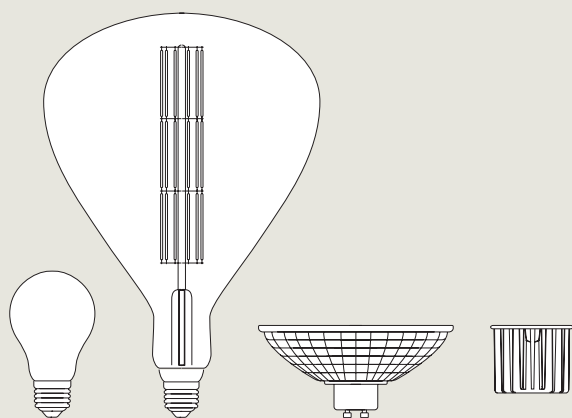

Light Strips
→ p. 58

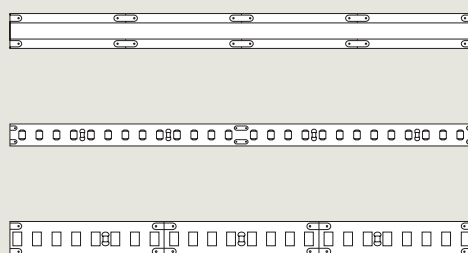

Profiles
→ p. 102

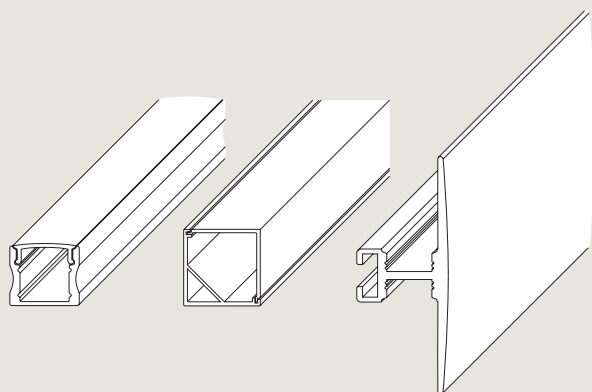

Drivers
→ p. 120

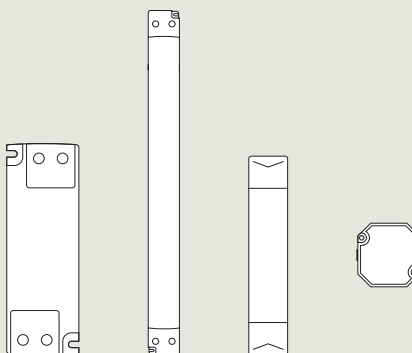

Controllers
→ p. 128

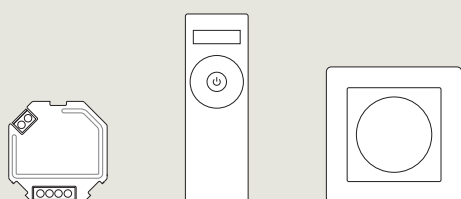

Nivo®
→ p. 138

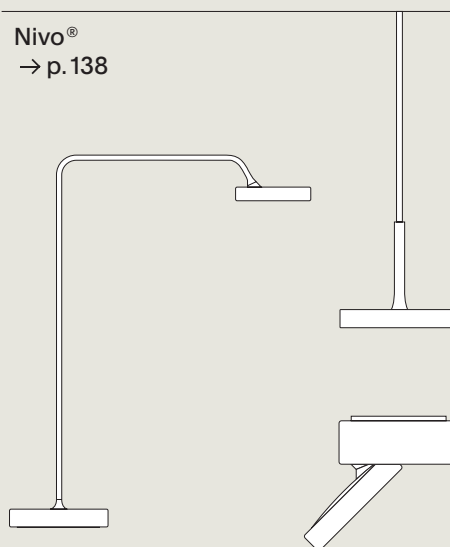

Architectural Lights
→ p. 154

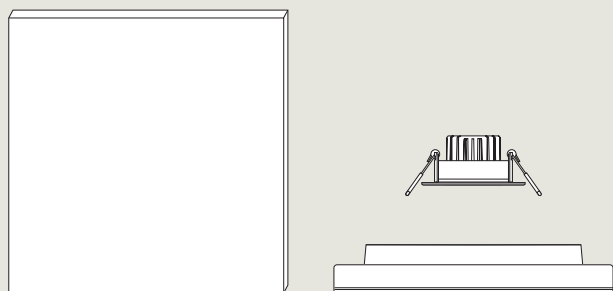

Battery Lights
→ p. 196

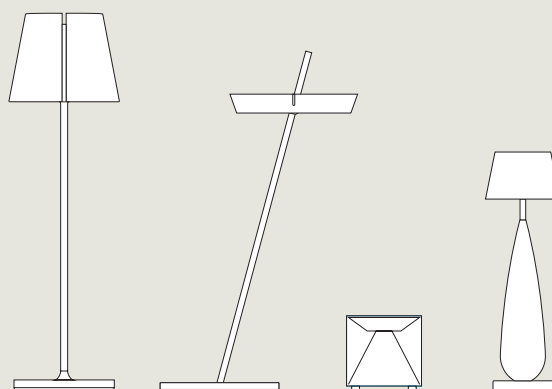

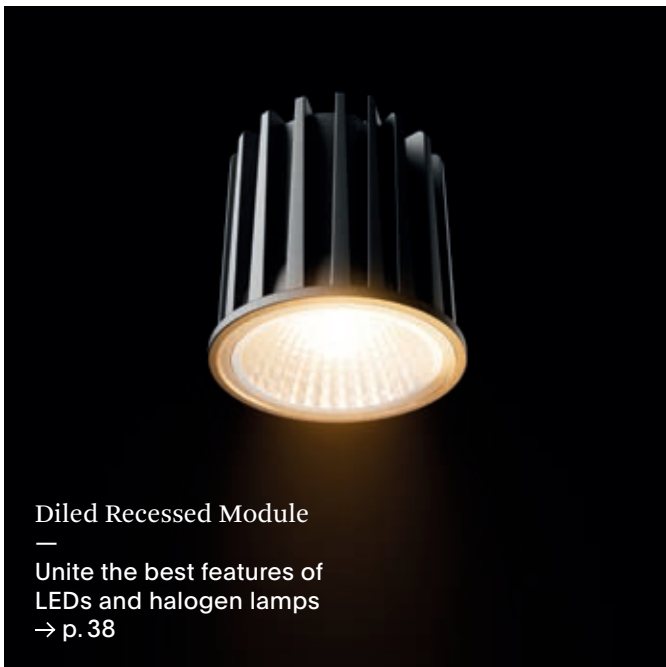

Diled Recessed Module
—
Unite the best features of LEDs and halogen lamps
→ p. 38



Filament Light Bulbs
—
Incandescent lamp look in the classic glass bulb
→ p. 12



Filament Light Bulbs Snow
—
White filaments perfect for open luminaires
→ p. 10



Linear Lamps
—
Full glass design in clear and opal versions
→ p. 54



Reflector Light Bulbs MR11/MR16
—
High-quality lens optics for objects and design
→ p. 46

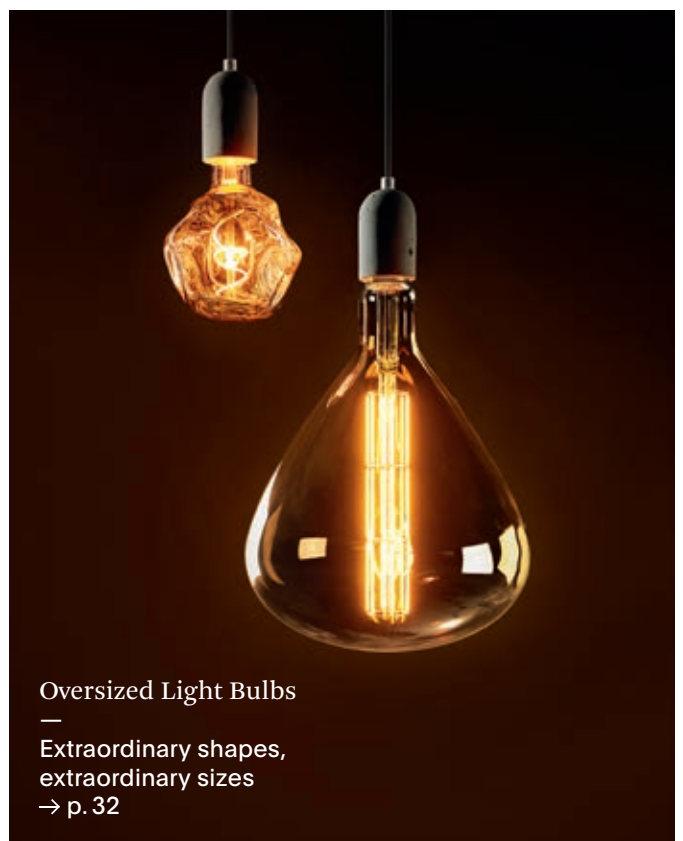





















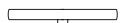



Oversized Light Bulbs
—
Extraordinary shapes, extraordinary sizes
→ p. 32

Lamps

Efficient, long-lasting, versatile
 High color rendering
 Dim-To-Warm
 Flicker-free

At SIGOR, we know: Each application has its own light requirements. That is why we offer a wide selection of lamps – providing a solution for every situation. Our modern LED light bulbs offer high energy efficiency, a long lifespan and excellent light quality. Features like Dim-To-Warm, high color rendering index and flicker-free light make it the ultimate choice for sophisticated applications in home and architectural lighting.



Filament Light Bulbs Snow p. 10		Edison Light Bulbs, Slim p. 26		Recessed Modules Diled p. 38		Pin Base Light Bulbs p. 52	
Filament Standard Light Bulbs p. 12		Edison Light Bulbs p. 28		Recessed Modules Fusion p. 40		Light Bulbs R7s p. 53	
Filament Candle Light Bulbs p. 16		Curved Light Bulbs p. 30		Recessed Modules Vion p. 42		Linear Lamps p. 54	
Filament Ball Light Bulbs p. 18		Oversized Light Bulbs p. 32		Reflector Light Bulbs PAR16 Diled p. 43		Tubes p. 57	
Filament Globe Light Bulbs p. 20		Reflector Light Bulbs GX53 p. 34		Reflector Light Bulbs PAR16 p. 44			
SMD Light Bulbs p. 22		Reflector Light Bulbs R39–R80 p. 36		Reflector Light Bulbs MR11/MR16 p. 46			
Light Bulbs in Special Shapes p. 24		Reflector Light Bulbs PAR20–PAR38 p. 37		Recessed Spotlights p. 48			
				Reflector Light Bulbs AR111/ES111 p. 50			

Filament Light Bulbs Snow

White filament for a uniform look in open luminaires
High color rendering – up to Ra 90



Filament Standard Light Bulb Snow, Clear

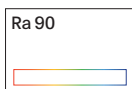
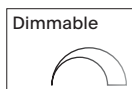

Product Code	Wattage	Watt Equiv.	Voltage	Base	Color Temp.	Luminous Flux	CRI	Dimmable	Diameter	Length	Lifespan	EEL	Unit	RRP*
6164001	4,8 W	40 W	230 V AC	E27	2.700 K	470 lm	90	yes	60 mm	105 mm	15.000 hrs		10	5,46 €
6164101	7 W	60 W	230 V AC	E27	2.700 K	806 lm	90	yes	60 mm	105 mm	15.000 hrs		10	5,80 €
6164201	9 W	68 W	230 V AC	E27	2.700 K	950 lm	90	yes	60 mm	105 mm	15.000 hrs		10	9,16 €
6164301	11 W	90 W	230 V AC	E27	2.700 K	1.350 lm	90	yes	60 mm	105 mm	15.000 hrs		10	11,34 €

Filament Candle Light Bulb Snow, Clear

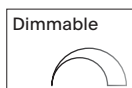

Product Code	Wattage	Watt Equiv.	Voltage	Base	Color Temp.	Luminous Flux	CRI	Dimmable	Diameter	Length	Lifespan	EEL	Unit	RRP*
6163001	2,8 W	25 W	230 V AC	E14	2.700 K	250 lm	90	yes	35 mm	97 mm	15.000 hrs		10	5,46 €
6163101	4,8 W	40 W	230 V AC	E14	2.700 K	470 lm	90	yes	35 mm	97 mm	15.000 hrs		10	5,80 €

Filament Edison Light Bulb Snow, Clear

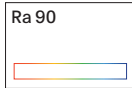
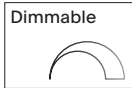

Product Code	Wattage	Watt Equiv.	Voltage	Base	Color Temp.	Luminous Flux	CRI	Dimmable	Diameter	Length	Lifespan	EEL	Unit	RRP*
6165001	7 W	60 W	230 V AC	E27	2.700 K	806 lm	90	yes	64 mm	140 mm	15.000 hrs		10	7,98 €

Filament Edison Light Bulb Slim Snow, Clear

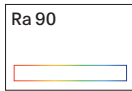
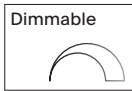

Product Code	Wattage	Watt Equiv.	Voltage	Base	Color Temp.	Luminous Flux	CRI	Dimmable	Diameter	Length	Lifespan	EEL	Unit	RRP*
6165101	4,8 W	32 W	230 V AC	E27	2.700 K	350 lm	90	yes	64 mm	140 mm	15.000 hrs		10	12,18 €

Filament Globe Light Bulb Snow, Clear

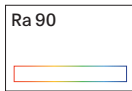
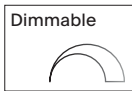

Product Code	Wattage	Watt Equiv.	Voltage	Base	Color Temp.	Luminous Flux	CRI	Dimmable	Diameter	Length	Lifespan	EEL	Unit	RRP*
6166001	7 W	60 W	230 V AC	E27	2.700 K	806 lm	90	yes	95 mm	138 mm	15.000 hrs		10	10,00 €

Filament Standard Light Bulbs

Very high color rendering – up to Ra 97
Up to 213 lm/W, energy efficiency class A
High dimmer compatibility



Filament Standard Light Bulb Class A, Frosted

Energy saving lamp for use in continuous lighting
Up to 213 lm/W, energy efficiency class A
Dimmable

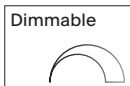

Product Code	Wattage	Watt Equiv.	Voltage	Base	Color Temp.	Luminous Flux	CRI	Dimmable	Diameter	Length	Lifespan	EEL	Unit	RRP*
6160501	2,2 W	40 W	230 V AC	E27	2.700 K	470 lm	80	yes	60 mm	108 mm	50.000 hrs	A	10	7,98 €
6160601	3,8 W	60 W	230 V AC	E27	2.700 K	806 lm	80	yes	60 mm	108 mm	50.000 hrs	A	10	10,00 €
6160701	5,8 W	75 W	230 V AC	E27	2.700 K	1.080 lm	80	yes	60 mm	108 mm	50.000 hrs	B	10	12,18 €
6160801	8,8 W	100 W	230 V AC	E27	2.700 K	1.630 lm	80	yes	60 mm	108 mm	50.000 hrs	B	10	13,87 €

Filament Standard Light Bulb Class A, Clear

Energy saving lamp for use in continuous lighting
Up to 213 lm/W, energy efficiency class A



Product Code	Wattage	Watt Equiv.	Voltage	Base	Color Temp.	Luminous Flux	CRI	Dimmable	Diameter	Length	Lifespan	EEL	Unit	RRP*
6160101	2,2 W	40 W	230 V AC	E27	3.000 K	470 lm	80	no	60 mm	108 mm	50.000 hrs	A	10	5,80 €
6160201	3,8 W	60 W	230 V AC	E27	3.000 K	806 lm	80	no	60 mm	108 mm	50.000 hrs	A	10	7,98 €
6160301	5 W	75 W	230 V AC	E27	3.000 K	1.055 lm	80	no	70 mm	126 mm	50.000 hrs	A	10	10,00 €
6160401	7,2 W	100 W	230 V AC	E27	3.000 K	1.521 lm	80	no	70 mm	126 mm	50.000 hrs	A	10	12,18 €

Filament Standard Light Bulb 97, Frosted

Highest color rendering, Ra 97

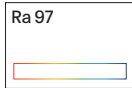
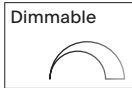

Product Code	Wattage	Watt Equiv.	Voltage	Base	Color Temp.	Luminous Flux	CRI	Dimmable	Diameter	Length	Lifespan	EEL	Unit	RRP*
6161301	4,8 W	40 W	230 V AC	E27	2.700 K	470 lm	97	yes	60 mm	108 mm	15.000 hrs		10	7,48 €
6161401	9 W	60 W	230 V AC	E27	2.700 K	806 lm	97	yes	60 mm	108 mm	15.000 hrs		10	7,98 €
6161501	11 W	75 W	230 V AC	E27	2.700 K	1.055 lm	97	yes	60 mm	108 mm	15.000 hrs		10	11,34 €

Filament Standard Light Bulb, Frosted, Dim-To-Warm

Automatic reduction of color temperature when dimming

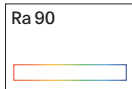
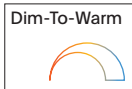

Product Code	Wattage	Watt Equiv.	Voltage	Base	Color Temp.	Luminous Flux	CRI	Dimmable	Diameter	Length	Lifespan	EEL	Unit	RRP*
6147401	7 W	60 W	230 V AC	E27	2.700-2.200 K	806 lm	90	yes	60 mm	108 mm	15.000 hrs		10	7,14 €
6148301	9 W	75 W	230 V AC	E27	2.700-2.200 K	1.055 lm	90	yes	60 mm	108 mm	15.000 hrs		10	10,50 €
6148401	11 W	100 W	230 V AC	E27	2.700-2.200 K	1.521 lm	90	yes	60 mm	108 mm	15.000 hrs		10	12,52 €

Filament Standard Light Bulb, Frosted

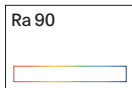
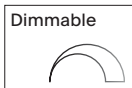

Product Code	Wattage	Watt Equiv.	Voltage	Base	Color Temp.	Luminous Flux	CRI	Dimmable	Diameter	Length	Lifespan	EEL	Unit	RRP*
Dimmable														
6130601	2,5 W	25 W	230 V AC	E27	2.700 K	250 lm	90	yes	60 mm	108 mm	15.000 hrs		10	5,46 €
6130701	4,5 W	40 W	230 V AC	E27	2.700 K	470 lm	90	yes	60 mm	108 mm	15.000 hrs		10	5,46 €
6130801	7 W	60 W	230 V AC	E27	2.700 K	806 lm	90	yes	60 mm	108 mm	15.000 hrs		10	5,80 €
6130901	9 W	75 W	230 V AC	E27	2.700 K	1.055 lm	90	yes	60 mm	108 mm	15.000 hrs		10	9,16 €
6131001	11 W	100 W	230 V AC	E27	2.700 K	1.521 lm	90	yes	60 mm	108 mm	15.000 hrs		10	11,34 €
Not dimmable														
6146201	4,5 W	40 W	230 V AC	E27	2.700 K	470 lm	90	no	60 mm	108 mm	15.000 hrs		10	3,78 €
6146301	7 W	60 W	230 V AC	E27	2.700 K	806 lm	90	no	60 mm	108 mm	15.000 hrs		10	4,12 €
6146401	8,5 W	75 W	230 V AC	E27	2.700 K	1.055 lm	90	no	60 mm	108 mm	15.000 hrs		10	7,14 €
6146501	10,5 W	100 W	230 V AC	E27	2.700 K	1.521 lm	90	no	60 mm	108 mm	15.000 hrs		10	9,16 €

Filament Standard Light Bulb, Clear



Product Code	Wattage		Voltage	Base	Color Temp.	Luminous Flux	CRI	Dimmable	Diameter	Length	Lifespan	EEL	Unit	RRP*
Dimmable														
6130001	2,5 W	25 W	230 V AC	E27	2.700 K	250 lm	90	yes	60 mm	108 mm	15.000 hrs		10	5,46 €
6130101	4,5 W	40 W	230 V AC	E27	2.700 K	470 lm	90	yes	60 mm	108 mm	15.000 hrs		10	5,46 €
6130201	7 W	60 W	230 V AC	E27	2.700 K	806 lm	90	yes	60 mm	108 mm	15.000 hrs		10	5,80 €
6130301	9 W	75 W	230 V AC	E27	2.700 K	1.055 lm	90	yes	60 mm	108 mm	15.000 hrs		10	9,16 €
6130401	11 W	100 W	230 V AC	E27	2.700 K	1.521 lm	90	yes	60 mm	108 mm	15.000 hrs		10	11,34 €
Not dimmable														
6131301	4,5 W	40 W	230 V AC	E27	2.700 K	470 lm	90	no	60 mm	108 mm	15.000 hrs		10	3,78 €
6131401	7 W	60 W	230 V AC	E27	2.700 K	806 lm	90	no	60 mm	108 mm	15.000 hrs		10	4,12 €
6143001	8,5 W	75 W	230 V AC	E27	2.700 K	1.055 lm	90	no	60 mm	108 mm	15.000 hrs		10	7,14 €
6143101	10,5 W	100 W	230 V AC	E27	2.700 K	1.521 lm	90	no	60 mm	108 mm	15.000 hrs		10	9,16 €

Filament Full Spectrum Standard Light Bulb, Clear

Balanced blue and red ratio

Very good color rendering, Ra 95

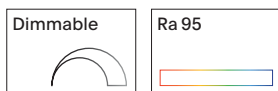
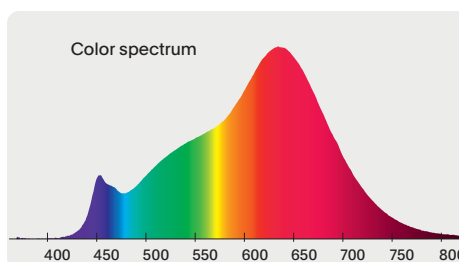

Product Code	Wattage	Watt Equiv.	Voltage	Base	Color Temp.	Luminous Flux	CRI	Dimmable	Diameter	Length	Lifespan	EEL	Unit	RRP*
6161001	7,5 W	60 W	230 V AC	E27	2.700 K	806 lm	95	yes	60 mm	108 mm	15.000 hrs		10	7,14 €
6161101	9 W	75 W	230 V AC	E27	2.700 K	1.055 lm	95	yes	60 mm	108 mm	15.000 hrs		10	10,50 €
6161201	11 W	100 W	230 V AC	E27	2.700 K	1.521 lm	95	yes	70 mm	126 mm	15.000 hrs		10	12,52 €

Filament Standard Light Bulb, Opal

Opal glass for a shadow-free illumination



Product Code	Wattage	Watt Equiv.	Voltage	Base	Color Temp.	Luminous Flux	CRI	Dimmable	Diameter	Length	Lifespan	EEL	Unit	RRP*
6140301	7 W	60 W	230 V AC	E27	2.700 K	806 lm	90	yes	60 mm	108 mm	15.000 hrs		10	5,80 €
6140401	9 W	75 W	230 V AC	E27	2.700 K	1.055 lm	90	yes	60 mm	108 mm	15.000 hrs		10	9,16 €

Filament Standard Light Bulb, Gold-Colored

2.500 K color temperature for a cozy atmosphere

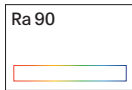
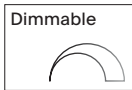

Product Code	Wattage	Watt Equiv.	Voltage	Base	Color Temp.	Luminous Flux	CRI	Dimmable	Diameter	Length	Lifespan	EEL	Unit	RRP*
6132301	4,5 W	37 W	230 V AC	E27	2.500 K	420 lm	90	yes	60 mm	108 mm	15.000 hrs		10	7,48 €
6132401	7 W	55 W	230 V AC	E27	2.500 K	720 lm	90	yes	60 mm	108 mm	15.000 hrs		10	7,98 €

Filament Mirrored Cup Light Bulb, Silver

Short filaments for glare-free lighting (7 W only)

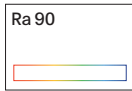
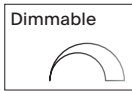

Product Code	Wattage	Watt Equiv.	Voltage	Base	Color Temp.	Luminous Flux	CRI	Dimmable	Diameter	Length	Lifespan	EEL	Unit	RRP*
6149501	7 W	50 W	230 V AC	E27	2.700 K	600 lm	90	yes	60 mm	108 mm	15.000 hrs		10	7,98 €
6135901	8,5 W	66 W	230 V AC	E27	2.700 K	900 lm	90	yes	60 mm	108 mm	15.000 hrs		10	10,00 €

Filament Mirrored Cup Light Bulb, Gold-Colored

Short filaments for glare-free lighting

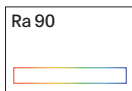
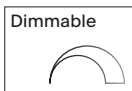

Product Code	Wattage	Watt Equiv.	Voltage	Base	Color Temp.	Luminous Flux	CRI	Dimmable	Diameter	Length	Lifespan	EEL	Unit	RRP*
6149601	7 W	50 W	230 V AC	E27	2.700 K	600 lm	90	yes	60 mm	108 mm	15.000 hrs		10	10,00 €

Filament Standard Light Bulb, Dusk-to-Dawn Sensor

Automatically turns on at approx. 15 Lux

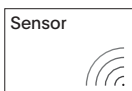

Product Code	Wattage	Watt Equiv.	Voltage	Base	Color Temp.	Luminous Flux	CRI	Dimmable	Diameter	Length	Lifespan	EEL	Unit	RRP*
6145901	7 W	60 W	230 V AC	E27	2.700 K	806 lm	80	no	60 mm	108 mm	15.000 hrs		10	12,18 €

Filament Candle Light Bulbs

High color rendering – up to Ra 90
High dimmer compatibility



Filament Candle Light Bulb, Frosted



Product Code	Wattage	Watt Equiv.	Voltage	Base	Color Temp.	Luminous Flux	CRI	Dimmable	Diameter	Length	Lifespan	EEL	Unit	RRP*
Dim-To-Warm														
6148701	2,5 W	25 W	230 V AC	E14	2.700–2.200 K	250 lm	90	yes	35 mm	97 mm	15.000 hrs	A F	10	7,14 €
6147601	4,5 W	40 W	230 V AC	E14	2.700–2.200 K	470 lm	90	yes	35 mm	97 mm	15.000 hrs	A F	10	7,98 €
Dimmable														
6132801	2,5 W	25 W	230 V AC	E14	2.700 K	250 lm	90	yes	35 mm	97 mm	15.000 hrs	A E	10	5,46 €
6132901	4,5 W	40 W	230 V AC	E14	2.700 K	470 lm	90	yes	35 mm	97 mm	15.000 hrs	A E	10	5,80 €
6146801	5 W	50 W	230 V AC	E14	2.700 K	630 lm	90	yes	35 mm	97 mm	15.000 hrs	A E	10	7,14 €

Filament Candle Light Bulb, Clear

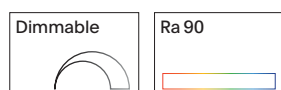

Product Code	Wattage	Watt Equiv.	Voltage	Base	Color Temp.	Luminous Flux	CRI	Dimmable	Diameter	Length	Lifespan	EEL	Unit	RRP*
6132501	2,5 W	25 W	230 V AC	E14	2.700 K	250 lm	90	yes	35 mm	97 mm	15.000 hrs	A E	10	5,46 €
6132601	4,5 W	40 W	230 V AC	E14	2.700 K	470 lm	90	yes	35 mm	97 mm	15.000 hrs	A E	10	5,80 €
6146701	5 W	50 W	230 V AC	E14	2.700 K	630 lm	90	yes	35 mm	97 mm	15.000 hrs	A E	10	7,14 €

Filament Candle Light Bulb, Opal

Opal glass for a shadow-free illumination



Product Code	Wattage	Watt Equiv.	Voltage	Base	Color Temp.	Luminous Flux	CRI	Dimmable	Diameter	Length	Lifespan	EEL	Unit	RRP*
6140801	4,5 W	40 W	230 V AC	E14	2.700 K	470 lm	90	yes	35 mm	97 mm	15.000 hrs		10	5,80 €

Filament Candle Light Bulb, Gold-Colored

2.400 K color temperature for a cozy atmosphere

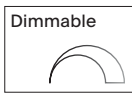

Product Code	Wattage	Watt Equiv.	Voltage	Base	Color Temp.	Luminous Flux	CRI	Dimmable	Diameter	Length	Lifespan	EEL	Unit	RRP*
6143401	2,5 W	22 W	230 V AC	E14	2.500 K	220 lm	80	yes	35 mm	100 mm	15.000 hrs		10	7,14 €
6133601	4 W	36 W	230 V AC	E14	2.400 K	410 lm	80	yes	35 mm	100 mm	15.000 hrs		10	7,98 €

Filament Candle Light Bulb, Twisted

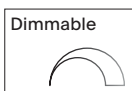

Product Code	Wattage	Watt Equiv.	Voltage	Base	Color Temp.	Luminous Flux	CRI	Dimmable	Diameter	Length	Lifespan	EEL	Unit	RRP*
6143501	4,5 W	40 W	230 V AC	E14	2.700 K	470 lm	80	yes	35 mm	100 mm	15.000 hrs		10	5,80 €

Filament Candle Light Bulb Windswept, Clear



Product Code	Wattage	Watt Equiv.	Voltage	Base	Color Temp.	Luminous Flux	CRI	Dimmable	Diameter	Length	Lifespan	EEL	Unit	RRP*
6134101	4,5 W	40 W	230 V AC	E14	2.700 K	470 lm	90	yes	35 mm	123 mm	15.000 hrs		10	5,80 €

Filament Ball Light Bulbs

High color rendering, Ra 90
High dimmer compatibility



Filament Ball Light Bulb, Frosted



Product Code	Wattage	Watt Equiv.	Voltage	Base	Color Temp.	Luminous Flux	CRI	Dimmable	Diameter	Length	Lifespan	EEL	Unit	RRP*
Dim-To-Warm														
6147701	4,5 W	40 W	230 V AC	E14	2.700–2.200 K	470 lm	90	yes	45 mm	80 mm	15.000 hrs		10	7,98 €
Dimmable														
6134601	2,5 W	25 W	230 V AC	E14	2.700 K	250 lm	90	yes	45 mm	80 mm	15.000 hrs		10	5,46 €
6134701	4,5 W	40 W	230 V AC	E14	2.700 K	470 lm	90	yes	45 mm	80 mm	15.000 hrs		10	5,80 €
6147001	5 W	50 W	230 V AC	E14	2.700 K	630 lm	90	yes	45 mm	80 mm	15.000 hrs		10	7,14 €

Filament Ball Light Bulb, Clear



Product Code	Wattage	Watt Equiv.	Voltage	Base	Color Temp.	Luminous Flux	CRI	Dimmable	Diameter	Length	Lifespan	EEL	Unit	RRP*
6134301	2,5 W	25 W	230 V AC	E14	2.700 K	250 lm	90	yes	45 mm	80 mm	15.000 hrs		10	5,46 €
6134401	4,5 W	40 W	230 V AC	E14	2.700 K	470 lm	90	yes	45 mm	80 mm	15.000 hrs		10	5,80 €
6146901	5 W	50 W	230 V AC	E14	2.700 K	630 lm	90	yes	45 mm	80 mm	15.000 hrs		10	7,14 €

Filament Ball Light Bulb, Opal

Opal glass for a shadow-free illumination



Product Code	Wattage	Watt Equiv.	Voltage	Base	Color Temp.	Luminous Flux	CRI	Dimmable	Diameter	Length	Lifespan	EEL	Unit	RRP*
6141101	4,5 W	40 W	230 V AC	E14	2.700 K	470 lm	90	yes	45 mm	80 mm	15.000 hrs		10	5,80 €

Filament Mirrored Cup Light Bulb, Silver

Glare-free light, suitable for mirror lighting



Product Code	Wattage	Watt Equiv.	Voltage	Base	Color Temp.	Luminous Flux	CRI	Dimmable	Diameter	Length	Lifespan	EEL	Unit	RRP*
6135801	4,5 W	35 W	230 V AC	E14	2.700 K	400 lm	90	yes	45 mm	80 mm	15.000 hrs		10	7,14 €

Filament Ball Light Bulb, Frosted

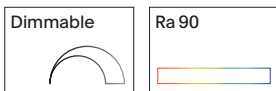

Product Code	Wattage	Watt Equiv.	Voltage	Base	Color Temp.	Luminous Flux	CRI	Dimmable	Diameter	Length	Lifespan	EEL	Unit	RRP*
6135601	4,5 W	40 W	230 V AC	E27	2.700 K	470 lm	90	yes	45 mm	78 mm	15.000 hrs		10	5,80 €
6143701	6,5 W	60 W	230 V AC	E27	2.700 K	806 lm	90	yes	45 mm	78 mm	15.000 hrs		10	7,98 €

Filament Ball Light Bulb, Clear



Product Code	Wattage	Watt Equiv.	Voltage	Base	Color Temp.	Luminous Flux	CRI	Dimmable	Diameter	Length	Lifespan	EEL	Unit	RRP*
Dim-To-Warm														
6148901	4,5 W	40 W	230 V AC	E27	2.700-2.200 K	470 lm	90	yes	45 mm	78 mm	15.000 hrs		10	7,98 €
Dimmable														
6135501	4,5 W	40 W	230 V AC	E27	2.700 K	470 lm	90	yes	45 mm	78 mm	15.000 hrs		10	5,80 €

Filament Globe Light Bulbs

High color rendering, Ra 90
High dimmer compatibility

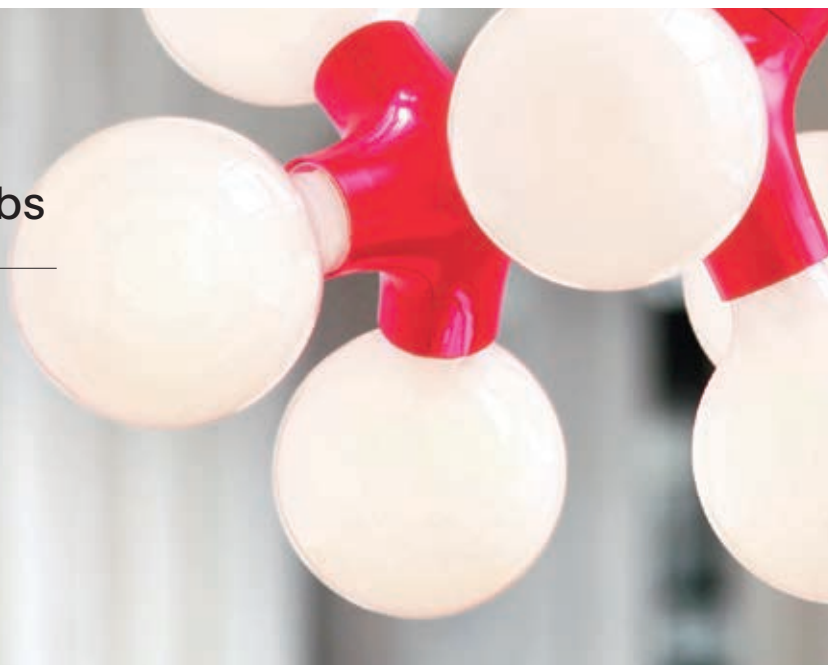

Filament Globe Light Bulb, Clear, 80 mm



Product Code	Wattage	Watt Equiv.	Voltage	Base	Color Temp.	Luminous Flux	CRI	Dimmable	Diameter	Length	Lifespan	EEL	Unit	RRP*
6147201	7 W	60 W	230 V AC	E27	2.700 K	806 lm	90	yes	80 mm	122 mm	15.000 hrs		10	10,00 €

Filament Globe Light Bulb, Clear, 95 mm



Product Code	Wattage	Watt Equiv.	Voltage	Base	Color Temp.	Luminous Flux	CRI	Dimmable	Diameter	Length	Lifespan	EEL	Unit	RRP*
6137501	4,5 W	40 W	230 V AC	E27	2.700 K	470 lm	90	yes	95 mm	140 mm	15.000 hrs		10	11,34 €
6137701	7 W	60 W	230 V AC	E27	2.700 K	806 lm	90	yes	95 mm	140 mm	15.000 hrs		10	12,18 €
6147901	9 W	75 W	230 V AC	E27	2.700 K	1.055 lm	90	yes	95 mm	140 mm	15.000 hrs		10	13,03 €
6148001	11 W	100 W	230 V AC	E27	2.700 K	1.521 lm	90	yes	95 mm	140 mm	15.000 hrs		10	13,87 €

Filament Globe Light Bulb, Clear, 125 mm



Product Code	Wattage	Watt Equiv.	Voltage	Base	Color Temp.	Luminous Flux	CRI	Dimmable	Diameter	Length	Lifespan	EEL	Unit	RRP*
6139401	7 W	60 W	230 V AC	E27	2.700 K	806 lm	90	yes	125 mm	178 mm	15.000 hrs		10	15,04 €

Filament Globe Light Bulb, Gold-Colored, 95 mm

2.500 K color temperature for a cozy atmosphere



Product Code	Wattage	Watt Equiv.	Voltage	Base	Color Temp.	Luminous Flux	CRI	Dimmable	Diameter	Length	Lifespan	EEL	Unit	RRP*
6138701	4,5 W	37 W	230 V AC	E27	2.500 K	420 lm	90	yes	95 mm	140 mm	15.000 hrs		10	13,03 €
6138901	7 W	55 W	230 V AC	E27	2.500 K	720 lm	90	yes	95 mm	140 mm	15.000 hrs		10	13,87 €
6148101	10 W	70 W	230 V AC	E27	2.500 K	1.055 lm	90	yes	95 mm	140 mm	15.000 hrs		10	15,04 €

Filament Globe Light Bulb, Opal, 80 mm

Opal glass for a shadow-free illumination

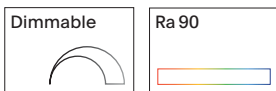

Product Code	Wattage	Watt Equiv.	Voltage	Base	Color Temp.	Luminous Flux	CRI	Dimmable	Diameter	Length	Lifespan	EEL	Unit	RRP*
6137301	7 W	60 W	230 V AC	E27	2.700 K	806 lm	90	yes	80 mm	122 mm	15.000 hrs		10	11,34 €
6147101	9 W	75 W	230 V AC	E27	2.700 K	1.055 lm	90	yes	80 mm	122 mm	15.000 hrs		10	12,18 €

Filament Globe Light Bulb, Opal, 95 mm

Opal glass for a shadow-free illumination



Product Code	Wattage	Watt Equiv.	Voltage	Base	Color Temp.	Luminous Flux	CRI	Dimmable	Diameter	Length	Lifespan	EEL	Unit	RRP*
6137901	7 W	60 W	230 V AC	E27	2.700 K	806 lm	90	yes	95 mm	140 mm	15.000 hrs		10	13,03 €
6138101	8,5 W	70 W	230 V AC	E27	2.700 K	1.055 lm	90	yes	95 mm	140 mm	15.000 hrs		10	13,87 €
6138201	11 W	100 W	230 V AC	E27	2.700 K	1.521 lm	90	yes	95 mm	140 mm	15.000 hrs		10	15,04 €

Filament Globe Light Bulb, Opal, 125 mm

Opal glass for a shadow-free illumination

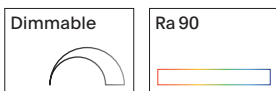

Product Code	Wattage	Watt Equiv.	Voltage	Base	Color Temp.	Luminous Flux	CRI	Dimmable	Diameter	Length	Lifespan	EEL	Unit	RRP*
6139001	7 W	60 W	230 V AC	E27	2.700 K	806 lm	90	yes	125 mm	178 mm	15.000 hrs		10	15,88 €
6139201	9 W	75 W	230 V AC	E27	2.700 K	1.055 lm	90	yes	125 mm	178 mm	15.000 hrs		10	16,72 €
6139301	11 W	100 W	230 V AC	E27	2.700 K	1.521 lm	90	yes	125 mm	178 mm	15.000 hrs		10	18,07 €

SMD Light Bulbs

Attractively priced light bulbs for general lighting
 High light output up to 3.452 lm
 Daylight white for commercial use



SMD Standard Light Bulb Ecolux

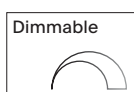

Product Code	Wattage	Watt Equiv.	Voltage	Base	Color Temp.	Luminous Flux	CRI	Dimmable	Diameter	Length	Lifespan	EEL	Unit	RRP*
5802201	8 W	60 W	230 V AC	E27	2.700 K	806 lm	80	yes	60 mm	107 mm	15.000 hrs		10	5,46 €
5802301	9,5 W	75 W	230 V AC	E27	2.700 K	1.055 lm	80	yes	60 mm	109 mm	15.000 hrs		10	7,14 €
5802401	13 W	100 W	230 V AC	E27	2.700 K	1.521 lm	80	yes	60 mm	118 mm	15.000 hrs		10	9,16 €
5810101	20 W	150 W	230 V AC	E27	2.700 K	2.452 lm	80	yes	70 mm	141 mm	15.000 hrs		10	13,87 €
5810201	27 W	200 W	230 V AC	E27	2.700 K	3.452 lm	80	yes	80 mm	154 mm	15.000 hrs		10	15,88 €

SMD Standard Light Bulb Ecolux



Product Code	Wattage	Watt Equiv.	Voltage	Base	Color Temp.	Luminous Flux	CRI	Dimmable	Diameter	Length	Lifespan	EEL	Unit	RRP*
Color Temperature: 2.700 K														
5803701	4,9 W	40 W	230 V AC	E27	2.700 K	470 lm	80	no	60 mm	107 mm	15.000 hrs		10	2,44 €
5803801	8 W	60 W	230 V AC	E27	2.700 K	806 lm	80	no	60 mm	107 mm	15.000 hrs		10	3,28 €
5803901	9,5 W	75 W	230 V AC	E27	2.700 K	1.055 lm	80	no	60 mm	105 mm	15.000 hrs		10	5,46 €
5802501	13,8 W	100 W	230 V AC	E27	2.700 K	1.521 lm	80	no	60 mm	115 mm	15.000 hrs		10	7,14 €
5802601	20 W	150 W	230 V AC	E27	2.700 K	2.452 lm	80	no	70 mm	141 mm	15.000 hrs		10	12,18 €
5802701	27 W	200 W	230 V AC	E27	2.700 K	3.452 lm	80	no	80 mm	154 mm	15.000 hrs		10	13,87 €
Color Temperature: 4.000 K														
5810501	13,8 W	100 W	230 V AC	E27	4.000 K	1.521 lm	80	no	60 mm	115 mm	15.000 hrs		10	7,14 €
5810601	20 W	150 W	230 V AC	E27	4.000 K	2.452 lm	80	no	70 mm	141 mm	15.000 hrs		10	12,18 €
5810701	27 W	200 W	230 V AC	E27	4.000 K	3.452 lm	80	no	80 mm	154 mm	15.000 hrs		10	13,87 €

SMD Candle Light Bulb Ecolux

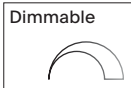

Product Code	Wattage	Watt Equiv.	Voltage	Base	Color Temp.	Luminous Flux	CRI	Dimmable	Diameter	Length	Lifespan	EEL	Unit	RRP*
5804301	4,9 W	40 W	230 V AC	E14	2.700 K	470 lm	80	yes	35 mm	102 mm	15.000 hrs		10	4,62 €
5804401	8 W	60 W	230 V AC	E14	2.700 K	806 lm	80	yes	35 mm	105 mm	15.000 hrs		10	5,80 €

SMD Ball Light Bulb Ecolux, E14

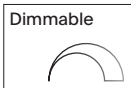

Product Code	Wattage	Watt Equiv.	Voltage	Base	Color Temp.	Luminous Flux	CRI	Dimmable	Diameter	Length	Lifespan	EEL	Unit	RRP*
5805301	5 W	40 W	230 V AC	E14	2.700 K	470 lm	80	yes	45 mm	82 mm	15.000 hrs		10	4,62 €
5805801	8 W	60 W	230 V AC	E14	2.700 K	806 lm	80	yes	45 mm	86 mm	15.000 hrs		10	5,80 €

Light Bulbs in Special Shapes

Extraordinary shapes for special applications



Filament Tube Light Bulb S28, Clear

A tiny light bulb with high output



Product Code	Wattage	Watt Equiv.	Voltage	Base	Color Temp.	Luminous Flux	CRI	Dimmable	Diameter	Length	Lifespan	EEL	Unit	RRP*
6146101	2,5 W	25 W	230 V AC	E14	2.700 K	250 lm	80	no	26 mm	61 mm	15.000 hrs		10	5,80 €

Filament Tube Light Bulb T25, Clear

For kitchen range hoods and piano lamps

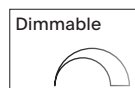

Product Code	Wattage	Watt Equiv.	Voltage	Base	Color Temp.	Luminous Flux	CRI	Dimmable	Diameter	Length	Lifespan	EEL	Unit	RRP*
Dimmable														
6140001	4,5 W	40 W	230 V AC	E14	2.700 K	470 lm	80	yes	25 mm	90 mm	15.000 hrs		10	7,98 €
Not dimmable														
6139901	2,5 W	25 W	230 V AC	E14	2.700 K	250 lm	80	no	25 mm	90 mm	15.000 hrs		10	5,80 €

Filament Tube Light Bulb T32, Clear

Perfect for narrow jars

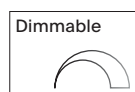

Product Code	Wattage	Watt Equiv.	Voltage	Base	Color Temp.	Luminous Flux	CRI	Dimmable	Diameter	Length	Lifespan	EEL	Unit	RRP*
6139701	4,5 W	40 W	230 V AC	E27	2.700 K	470 lm	80	yes	32 mm	106 mm	15.000 hrs		10	7,98 €
6139801	6,5 W	60 W	230 V AC	E27	2.700 K	806 lm	80	yes	32 mm	106 mm	15.000 hrs		10	12,18 €

Filament Pear-Shaped Light Bulb, Opal



Product Code	Wattage	Watt Equiv.	Voltage	Base	Color Temp.	Luminous Flux	CRI	Dimmable	Diameter	Length	Lifespan	EEL	Unit	RRP*
5780901	1,5 W	15 W	230 V AC	E14	2.700 K	144 lm	80	no	25 mm	59 mm	15.000 hrs		10	4,12 €
5781001	2,3 W	20 W	230 V AC	E14	2.700 K	200 lm	80	no	25 mm	63 mm	15.000 hrs		10	5,46 €

SMD Tube Light Bulb B15d, Clear

Suitable for use in design lamps

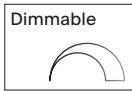

Product Code	Wattage	Watt Equiv.	Voltage	Base	Color Temp.	Luminous Flux	CRI	Dimmable	Diameter	Length	Lifespan	EEL	Unit	RRP*
Dimmable														
5758201	8 W	75 W	230 V AC	B15d	2.700 K	1.055 lm	80	yes	18 mm	90 mm	15.000 hrs		10	24,29 €
Not dimmable														
5758001	7 W	60 W	230 V AC	B15d	2.700 K	806 lm	80	no	18 mm	90 mm	15.000 hrs		10	20,08 €

SMD Tube Light Bulb, Clear, E14

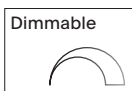

Product Code	Wattage	Watt Equiv.	Voltage	Base	Color Temp.	Luminous Flux	CRI	Dimmable	Diameter	Length	Lifespan	EEL	Unit	RRP*
5784101	7 W	60 W	230 V AC	E14	2.700 K	806 lm	80	yes	20 mm	92 mm	15.000 hrs		10	20,08 €

Special Shape Filament Light Bulb Eldea®, Opal

Exclusive only by SIGOR

Designed for bathroom and makeup mirror lights

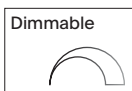

Product Code	Wattage	Watt Equiv.	Voltage	Base	Color Temp.	Luminous Flux	CRI	Dimmable	Diameter	Length	Lifespan	EEL	Unit	RRP*
6127201	4 W	40 W	230 V AC	E14	2.700 K	400 lm	80	yes	72 mm	78 mm	25.000 hrs		10	13,87 €

Edison Light Bulbs Slim

Modern lighting technology with the vintage look of a carbon filament light bulb



Edison Light Bulb Slim Curved, Gold-Colored

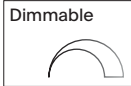

Product Code	Wattage	Watt Equiv.	Voltage	Base	Color Temp.	Luminous Flux	CRI	Dimmable	Diameter	Length	Lifespan	EEL	Unit	RRP*
6128001	5,5 W	40 W	230 V AC	E27	2.500 K	470 lm	80	yes	64 mm	140 mm	15.000 hrs	P	10	10,00 €

Edison Light Bulb Slim Spiral, Gold-Colored

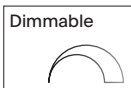

Product Code	Wattage	Watt Equiv.	Voltage	Base	Color Temp.	Luminous Flux	CRI	Dimmable	Diameter	Length	Lifespan	EEL	Unit	RRP*
6128101	7 W	50 W	230 V AC	E27	2.500 K	640 lm	80	yes	64 mm	140 mm	15.000 hrs	P	10	13,87 €

Edison Light Bulb Slim, Gold-Colored

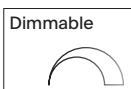

Product Code	Wattage	Watt Equiv.	Voltage	Base	Color Temp.	Luminous Flux	CRI	Dimmable	Diameter	Length	Lifespan	EEL	Unit	RRP*
6128201	7 W	50 W	230 V AC	E27	2.500 K	640 lm	80	yes	64 mm	140 mm	15.000 hrs	P	10	15,88 €

Edison Light Bulbs

Modern LED technology
with a vintage look



Edison Light Bulb, Clear



Product Code	Wattage	Watt Equiv.	Voltage	Base	Color Temp.	Luminous Flux	CRI	Dimmable	Diameter	Length	Lifespan	EEL	Unit	RRP*
Dim-To-Warm														
6149301	7 W	60 W	230 V AC	E27	2.700–2.200 K	806 lm	90	yes	64 mm	140 mm	15.000 hrs		10	10,00 €
Dimmable														
6136201	7 W	60 W	230 V AC	E27	2.700 K	806 lm	90	yes	64 mm	140 mm	15.000 hrs		10	7,98 €

Edison Light Bulb, Gold-Colored

2.500 K color temperature for a cozy atmosphere

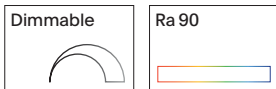

Product Code	Wattage	Watt Equiv.	Voltage	Base	Color Temp.	Luminous Flux	CRI	Dimmable	Diameter	Length	Lifespan	EEL	Unit	RRP*
6136701	4,5 W	37 W	230 V AC	E27	2.500 K	420 lm	90	yes	64 mm	140 mm	15.000 hrs		10	7,98 €
6136901	7 W	55 W	230 V AC	E27	2.500 K	720 lm	90	yes	64 mm	140 mm	15.000 hrs		10	10,00 €

Edison Light Bulb, Titanium

1.800 K color temperature for a cozy atmosphere

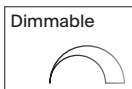

Product Code	Wattage	Watt Equiv.	Voltage	Base	Color Temp.	Luminous Flux	CRI	Dimmable	Diameter	Length	Lifespan	EEL	Unit	RRP*
6136801	7 W	30 W	230 V AC	E27	1.800 K	320 lm	80	yes	64 mm	140 mm	15.000 hrs		10	11,34 €

Curved Light Bulbs

A unique look with helix filaments
1.800 K and low luminous flux
For a cozy, glare-free ambience



Curved Standard Light Bulb, Gold-Colored

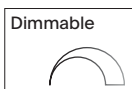

Product Code	Wattage	Watt Equiv.	Voltage	Base	Color Temp.	Luminous Flux	CRI	Dimmable	Diameter	Length	Lifespan	EEL	Unit	RRP*
6125001	2,5 W	15 W	230 V AC	E27	1.800 K	136 lm	80	yes	60 mm	108 mm	15.000 hrs	—	10	7,98 €

Curved Candle Light Bulb, Gold-Colored

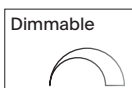

Product Code	Wattage	Watt Equiv.	Voltage	Base	Color Temp.	Luminous Flux	CRI	Dimmable	Diameter	Length	Lifespan	EEL	Unit	RRP*
6125201	2,5 W	15 W	230 V AC	E14	1.800 K	136 lm	80	yes	35 mm	97 mm	15.000 hrs	—	10	7,98 €

Curved Tube Light Bulb, Gold-Colored

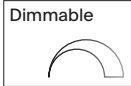

Product Code	Wattage	Watt Equiv.	Voltage	Base	Color Temp.	Luminous Flux	CRI	Dimmable	Diameter	Length	Lifespan	EEL	Unit	RRP*
6125501	4 W	25 W	230 V AC	E27	1.800 K	250 lm	80	yes	32 mm	185 mm	15.000 hrs	—	10	12,18 €

Curved Edison Light Bulb, Gold-Colored

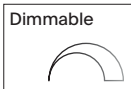

Product Code	Wattage	Watt Equiv.	Voltage	Base	Color Temp.	Luminous Flux	CRI	Dimmable	Diameter	Length	Lifespan	EEL	Unit	RRP*
6125601	4,5 W	25 W	230 V AC	E27	1.800 K	250 lm	80	yes	64 mm	140 mm	15.000 hrs	—	10	10,00 €

Curved Globe Light Bulb, 95 mm, Gold-Colored

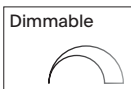

Product Code	Wattage	Watt Equiv.	Voltage	Base	Color Temp.	Luminous Flux	CRI	Dimmable	Diameter	Length	Lifespan	EEL	Unit	RRP*
6125801	4 W	25 W	230 V AC	E27	1.800 K	250 lm	80	yes	95 mm	140 mm	15.000 hrs	—	10	12,18 €

Oversized Light Bulbs

Extraordinary shapes,
extraordinary sizes

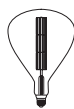

Giant Ball Light Bulb, Metallic



	Product Code	Wattage	Style	Voltage	Base	Color Temp.	Luminous Flux	CRI	Dimmable	Diameter	Length	Lifespan	EEL	Unit	RRP*
1	6126801	4 W	copper	230 V AC	E27	1.800 K	120 lm	90	yes	125 mm	176 mm	15.000 hrs	—	10	29,33 €
2	6126901	4 W	silver	230 V AC	E27	1.800 K	75 lm	90	yes	125 mm	176 mm	15.000 hrs	—	10	29,33 €

Giant Drop Light Bulb, Metallic

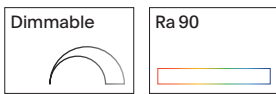

	Product Code	Wattage	Style	Voltage	Base	Color Temp.	Luminous Flux	CRI	Dimmable	Diameter	Length	Lifespan	EEL	Unit	RRP*
1	6126601	4 W	copper	230 V AC	E27	1.800 K	120 lm	90	yes	165 mm	280 mm	15.000 hrs	—	6	37,73 €
2	6126701	6 W	silver	230 V AC	E27	1.800 K	160 lm	90	yes	165 mm	280 mm	15.000 hrs	—	6	37,73 €

Giant Drop Light Bulb

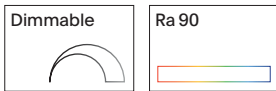

	Product Code	Wattage	Style	Voltage	Base	Color Temp.	Luminous Flux	CRI	Dimmable	Diameter	Length	Lifespan	EEL	Unit	RRP*
1	6126001	5 W	gold-colored	230 V AC	E27	1.800 K	260 lm	90	yes	165 mm	280 mm	15.000 hrs	—	6	37,73 €
2	6126101	5 W	titanium	230 V AC	E27	1.800 K	120 lm	90	yes	165 mm	280 mm	15.000 hrs	—	6	37,73 €

Giant Tear-Shaped Light Bulb



	Product Code	Wattage	Style	Voltage	Base	Color Temp.	Luminous Flux	CRI	Dimmable	Diameter	Length	Lifespan	EEL	Unit	RRP*
1	6126201	8 W	gold-colored	230 V AC	E27	1.800 K	600 lm	90	yes	245 mm	365 mm	25.000 hrs	—	4	67,14 €
2	6126301	8 W	titanium	230 V AC	E27	1.800 K	240 lm	90	yes	245 mm	365 mm	25.000 hrs	—	4	67,14 €

Reflector Light Bulbs GX53

High color rendering – up to Ra 90
Flat design
Also available in dimmable versions



Reflector Light Bulb GX53 Argent

—
Ultra flat design with a 30° beam angle
High quality lens optics for objects and design
High color rendering, Ra 90
Various light colors (2.700 K and 3.000 K)

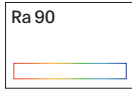
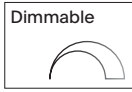

Product Code	Wattage	Watt Equiv.	Voltage	Base	Color Temp.	Luminous Flux	CRI	Dimmable	Angle	Diameter	Length	Lifespan	EEL	Unit	RRP*
5766501	10 W	60 W	230 V AC	GX53	2.700 K	630 lm	90	yes	30°	75 mm	24 mm	25.000 hrs		10	29,83 €
5766601	10 W	60 W	230 V AC	GX53	3.000 K	630 lm	90	yes	30°	75 mm	24 mm	25.000 hrs		10	29,83 €

Reflector Light Bulb GX53 Luxar, Dimmable

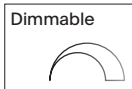

Product Code	Wattage	Watt Equiv.	Voltage	Base	Color Temp.	Luminous Flux	CRI	Dimmable	Diameter	Length	Lifespan	EEL	Unit	RRP*
5784801	6,5 W	13 W CFL	230 V AC	GX53	2.700 K	600 lm	80	yes	75 mm	25 mm	15.000 hrs		10	10,00 €
5784901	6,5 W	13 W CFL	230 V AC	GX53	4.000 K	600 lm	80	yes	75 mm	25 mm	15.000 hrs		10	10,00 €

Reflector Light Bulb GX53 Luxar



Product Code	Wattage	Watt Equiv.	Voltage	Base	Color Temp.	Luminous Flux	CRI	Dimmable	Diameter	Length	Lifespan	EEL	Unit	RRP*
5784501	4,5 W	10 W CFL	230 V AC	GX53	2.700 K	470 lm	80	no	75 mm	25 mm	15.000 hrs		10	5,80 €
5784601	4,5 W	10 W CFL	230 V AC	GX53	4.000 K	470 lm	80	no	75 mm	25 mm	15.000 hrs		10	5,80 €

Reflector Light Bulbs R39–R80

High color rendering – up to Ra 90
Perfect for home and commercial applications



Reflector Light Bulb R39 Luxar



Product Code	Wattage	Watt Equiv.	Voltage	Base	Color Temp.	Luminous Flux	CRI	Dimmable	Angle	Diameter	Length	Lifespan	EEL	Unit	RRP*
5793001	1,5 W	25 W	230 V AC	E14	2.700 K	110 lm	80	no	36°	39 mm	70 mm	15.000 hrs		10	5,46 €

Reflector Light Bulb R50 Luxar



Product Code	Wattage	Watt Equiv.	Voltage	Base	Color Temp.	Luminous Flux	CRI	Dimmable	Angle	Diameter	Length	Lifespan	EEL	Unit	RRP*
5793101	5,5 W	50 W	230 V AC	E14	2.700 K	345 lm	90	yes	36°	50 mm	85 mm	25.000 hrs		10	7,98 €

Reflector Light Bulb R63 Luxar



Product Code	Wattage	Watt Equiv.	Voltage	Base	Color Temp.	Luminous Flux	CRI	Dimmable	Angle	Diameter	Length	Lifespan	EEL	Unit	RRP*
5793201	5,5 W	50 W	230 V AC	E27	2.700 K	345 lm	90	yes	36°	63 mm	102 mm	25.000 hrs		10	9,16 €

Reflector Light Bulb R80 Luxar



Product Code	Wattage	Watt Equiv.	Voltage	Base	Color Temp.	Luminous Flux	CRI	Dimmable	Angle	Diameter	Length	Lifespan	EEL	Unit	RRP*
5793301	9,6 W	80 W	230 V AC	E27	2.700 K	700 lm	90	yes	36°	80 mm	113 mm	25.000 hrs		10	12,18 €

Reflector Light Bulbs PAR20-PAR38

High color rendering, Ra 90
 High quality reflectors for glare-free light
 Suitable for exhibition spaces and sales rooms



Reflector Light Bulb PAR20 Luxar

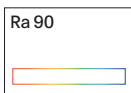
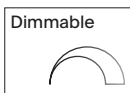

Product Code	Wattage	Watt Equiv.	Voltage	Base	Color Temp.	Luminous Flux	CRI	Dimmable	Angle	Diameter	Length	Lifespan	EEI	Unit	RRP*
5785601	6,4 W	50 W	230 V AC	E27	2.700 K	350 lm	90	yes	36°	65 mm	88 mm	15.000 hrs		10	10,00 €

Reflector Light Bulb PAR30 Luxar

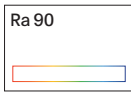
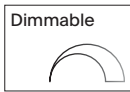

Product Code	Wattage	Watt Equiv.	Voltage	Base	Color Temp.	Luminous Flux	CRI	Dimmable	Angle	Diameter	Length	Lifespan	EEI	Unit	RRP*
5785701	10 W	75 W	230 V AC	E27	2.700 K	633 lm	90	yes	36°	95 mm	93 mm	15.000 hrs		10	18,07 €

Reflector Light Bulb PAR38 Luxar Outdoors

Can be used outdoors
 Suitable for ground spike lamps

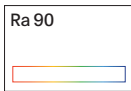
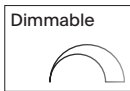

Product Code	Wattage	Watt Equiv.	Voltage	Base	Color Temp.	Luminous Flux	CRI	Dimmable	Angle	Diameter	Length	Lifespan	EEI	Unit	RRP*
5785801	15,2 W	120 W	230 V AC	E27	2.700 K	1.035 lm	90	yes	30°	122 mm	134 mm	15.000 hrs		10	25,13 €

Recessed Modules Diled

Our Diled recessed modules unite the best features of halogen lights and LEDs. With the mirrored reflector, the Diled lights offer the same glare-free optics as halogen light bulbs. When used in recessed spotlights, they impress with their extremely high color rendering (Ra 95) and optional Dim-To-Warm technology. These durable modules can be connected directly to 230 V and are ideal for installation in tight-fitting suspended ceilings.



Recessed Module Diled 230 V

—
Glare-free light thanks to the reflectors
Visual appearance of a halogen bulb
Highest color rendering (Ra 95) and Dim-To-Warm technology
Various beam angles and color temperatures

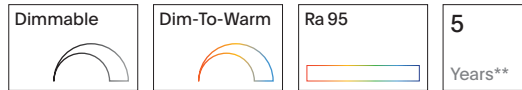

Product Code	Wattage	Watt Equiv.	Voltage	Base	Color Temp.	Luminous Flux	CRI	Dimmable	Angle	Diameter	Length	Lifespan	EEL	Unit	RRP*
Dim-To-Warm															
5720001	6 W	60 W	230 V AC	—	2.700–2.100 K	360 lm	95	yes	36°	50 mm	39 mm	50.000 hrs	A G	10	28,15 €
5720301 New	6 W	60 W	230 V AC	—	2.700–2.100 K	360 lm	95	yes	60°	50 mm	39 mm	50.000 hrs	A G	10	28,15 €
Dimmable															
5720701 New	6 W	60 W	230 V AC	—	2.700 K	355 lm	95	yes	24°	50 mm	39 mm	50.000 hrs	A G	10	23,95 €
5720101	6 W	60 W	230 V AC	—	2.700 K	370 lm	95	yes	36°	50 mm	39 mm	50.000 hrs	A G	10	23,95 €
5720401	6 W	60 W	230 V AC	—	2.700 K	380 lm	95	yes	60°	50 mm	39 mm	50.000 hrs	A G	10	23,95 €
5720801 New	6 W	60 W	230 V AC	—	3.000 K	390 lm	95	yes	24°	50 mm	39 mm	50.000 hrs	A G	10	23,95 €
5720201	6 W	60 W	230 V AC	—	3.000 K	380 lm	95	yes	36°	50 mm	39 mm	50.000 hrs	A G	10	23,95 €
5720501	6 W	60 W	230 V AC	—	3.000 K	380 lm	95	yes	60°	50 mm	39 mm	50.000 hrs	A G	10	23,95 €

Recessed Module Diled 230 V

—
Glare-free light thanks to the reflectors
Visual appearance of a halogen bulb
Highest color rendering (Ra 95) and Dim-To-Warm technology
Various beam angles and color temperatures

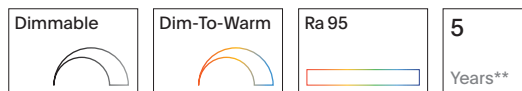

Product Code	Wattage	Watt Equiv.	Voltage	Base	Color Temp.	Luminous Flux	CRI	Dimmable	Angle	Diameter	Length	Lifespan	EEL	Unit	RRP*
Dim-To-Warm															
5721001	9 W	70 W	230 V AC	—	2.700–2.100 K	540 lm	95	yes	36°	50 mm	51 mm	50.000 hrs	A G	10	32,35 €
Dimmable															
5721701 New	8 W	80 W	230 V AC	—	2.700 K	530 lm	95	yes	24°	50 mm	51 mm	50.000 hrs	A G	10	28,15 €
5721101	9 W	80 W	230 V AC	—	2.700 K	570 lm	95	yes	36°	50 mm	51 mm	50.000 hrs	A G	10	28,15 €
5721401	9 W	80 W	230 V AC	—	2.700 K	570 lm	95	yes	60°	50 mm	51 mm	50.000 hrs	A G	10	28,15 €
5721801 New	8 W	80 W	230 V AC	—	3.000 K	540 lm	95	yes	24°	50 mm	51 mm	50.000 hrs	A G	10	28,15 €
5721201	9 W	80 W	230 V AC	—	3.000 K	570 lm	95	yes	36°	50 mm	51 mm	50.000 hrs	A G	10	28,15 €
5721501	9 W	80 W	230 V AC	—	3.000 K	580 lm	95	yes	60°	50 mm	51 mm	50.000 hrs	A G	10	28,15 €
5721301 New	8 W	80 W	230 V AC	—	4.000 K	610 lm	95	yes	36°	50 mm	51 mm	50.000 hrs	A G	10	28,15 €

** Consumer warranty only. Warranty conditions on page 258.

Recessed Modules Fusion

The Fusion series is an all-rounder for sophisticated projects. With its wide selection of optics, it offers a variety of solutions for light texture and light patterns. The light modules' 24 V technology seamlessly integrates with common lighting control systems. Also available with a built-in 230 V driver for even greater flexibility.



Recessed Module Fusion 24 V

High color rendering, Ra 90
Enhanced thermal management
Only to be operated in assembly with optics
Suitable 24 V drivers starting page 120

Dimmable 	Ra 90 	5 Years**
--------------	-----------	--------------

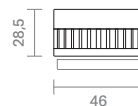

Product Code	Wattage	Voltage	Luminous Flux	Color Temp.	CRI	Dimmable	Diameter	Length	Lifespan	EEL	Unit	RRP*
5473101	7,3 W	24 V DC	685 lm	2.700 K	90	yes	46 mm	28,5 mm	55.000 hrs		10	29,33 €
5473201	7,3 W	24 V DC	685 lm	3.000 K	90	yes	46 mm	28,5 mm	55.000 hrs		10	29,33 €
5473301	7,3 W	24 V DC	685 lm	4.000 K	90	yes	46 mm	28,5 mm	55.000 hrs		10	29,33 €

New. Recessed Module Fusion 230 V

High color rendering, Ra 90
Only to be operated in assembly with optics
Dimmable using an LED universal dimmer
Flicker-free

Dimmable 	Ra 90 	5 Years**
--------------	-----------	--------------

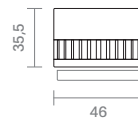

Product Code	Wattage	Voltage	Luminous Flux	Color Temp.	CRI	Dimmable	Diameter	Length	Lifespan	EEL	Unit	RRP*
5473601	6 W	230 V AC	470 lm	2.700 K	90	yes	46 mm	35,5 mm	55.000 hrs		10	33,53 €
5473701	6 W	230 V AC	480 lm	3.000 K	90	yes	46 mm	35,5 mm	55.000 hrs		10	33,53 €
5473801	6 W	230 V AC	520 lm	4.000 K	90	yes	46 mm	35,5 mm	55.000 hrs		10	33,53 €

** Consumer warranty only. Warranty conditions on page 258.

Recessed Module Fusion Models



HLO – Highly Efficient Lens Model

This reflector-like lens offers the highest light efficiency in this series. The cone of light is clearly defined.

Product Code	Luminous Flux Fusion 24 V DC	Luminous Flux Fusion 230 V AC	Angle	RRP*
5474001	610 lm	380 lm	15°	7,14 €
5474101	610 lm	380 lm	24°	7,14 €
5474201	610 lm	380 lm	36°	7,14 €
5474301	600 lm	380 lm	60°	7,14 €



HRO – Highly Efficient Reflector Model

This reflector is made of vacuum-coated aluminum, creating a high-quality metallic texture, guaranteeing glare-free lighting with a soft light pattern.

Product Code	Luminous Flux Fusion 24 V DC	Luminous Flux Fusion 230 V AC	Angle	RRP*
5474401	590 lm	390 lm	15°	5,80 €
5474501	590 lm	390 lm	25°	5,80 €
5474601	590 lm	390 lm	38°	5,80 €
5474701	590 lm	390 lm	60°	5,80 €



FLO – Flat Lens Model

Due to its flat design, this model is ideal for installation in tight-fitting suspended ceilings. At the same time, it gives good control over the lighting.

Product Code	Luminous Flux Fusion 24 V DC	Luminous Flux Fusion 230 V AC	Angle	RRP*
5474801	570 lm	400 lm	15°	5,80 €
5474901	580 lm	400 lm	24°	5,80 €
5475001	570 lm	400 lm	36°	5,80 €
5475101	600 lm	400 lm	60°	5,80 €



ALO – Architecture Lens Model

It uses crossed light distribution technology, which significantly reduces the glare index. The anti-glare ring is available in 4 colors to meet the requirements of different architectural styles.

Product Code	Color	Luminous Flux Fusion 24 V DC	Luminous Flux Fusion 230 V AC	Angle	RRP*
1 5475201	white	500 lm	390 lm	38°	10,00 €
2 5475301	black	500 lm	390 lm	38°	10,00 €
3 5475401	gold-colored	480 lm	390 lm	38°	10,00 €
4 5475501	aluminum, polished	500 lm	390 lm	38°	10,00 €



New.

Recessed Modules Vion

The Vion series impresses with its compact design. Color temperature can be adjusted directly on the module for maximum flexibility. With its 230 V connector and a variety of applications, it is ideal for a wide range of projects. It is a cost-effective solution for sophisticated lighting concepts.



New. Recessed Module Vion 230 V

—
Ceramic body
Light color can be adjusted using the DIP switch
Dimmable

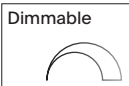

Product Code	Wattage	Watt Equiv.	Voltage	Base	Color Temp.	Luminous Flux	CRI	Dimmable	Angle	Diameter	Length	Lifespan	EEL	Unit	RRP*
5794601	4 W	40 W	230 V AC	—	4.000/2.700/2.200 K	350 lm	80	yes	38°	50 mm	26 mm	25.000 hrs	A B E	10	8,32 €
5794701	7 W	60 W	230 V AC	—	4.000/2.700/2.200 K	640 lm	80	yes	38°	50 mm	26 mm	25.000 hrs	A B E	10	10,00 €
5794801	9 W	80 W	230 V AC	—	4.000/2.700/2.200 K	806 lm	80	yes	38°	50 mm	26 mm	25.000 hrs	A B E	10	11,68 €

Reflector Light Bulbs PAR16 Diled

With the familiar look of a halogen lamp, Diled reflector lamps offer maximum color rendering (Ra 95), glare-free light distribution, and optimal heat management. Perfect for projects where ultimate light quality and durability are essential.



Reflector Light Bulb PAR16 Diled 95

Glare-free light thanks to the reflectors
Visual appearance of a halogen bulb
Project light bulb with highest color rendering (Ra 95) and a 50.000 hrs lifespan



Dimmable 	Dim-To-Warm 	Ra 95 	5 Years**
--------------	-----------------	-----------	--------------

Product Code	Wattage	Watt Equiv.	Voltage	Base	Color Temp.	Luminous Flux	CRI	Dimmable	Angle	Diameter	Length	Lifespan	EEL	Unit	RRP*
Dim-To-Warm															
5731001	6 W	40 W	230 V AC	GU10	2.700–2.200 K	345 lm	95	yes	36°	50 mm	60 mm	50.000 hrs		10	20,08 €
Dimmable															
5731101	6 W	60 W	230 V AC	GU10	2.700 K	360 lm	95	yes	36°	50 mm	60 mm	50.000 hrs		10	15,88 €
5731201	6 W	60 W	230 V AC	GU10	3.000 K	375 lm	95	yes	36°	50 mm	60 mm	50.000 hrs		10	15,88 €

Reflector Light Bulb PAR16 Diled 95

Glare-free light thanks to the reflectors
Visual appearance of a halogen bulb
Project light bulb with highest color rendering (Ra 95) and a 50.000 hrs lifespan



Dimmable 	Dim-To-Warm 	Ra 95 	5 Years**
--------------	-----------------	-----------	--------------

Product Code	Wattage	Watt Equiv.	Voltage	Base	Color Temp.	Luminous Flux	CRI	Dimmable	Angle	Diameter	Length	Lifespan	EEL	Unit	RRP*
Dim-To-Warm															
5731501	7,5 W	70 W	230 V AC	GU10	2.700–2.200 K	520 lm	95	yes	36°	50 mm	62,5 mm	50.000 hrs		10	23,95 €
Dimmable															
5731601	7,5 W	80 W	230 V AC	GU10	2.700 K	575 lm	95	yes	36°	50 mm	62,5 mm	50.000 hrs		10	20,08 €
5731701	7,5 W	80 W	230 V AC	GU10	3.000 K	575 lm	95	yes	36°	50 mm	62,5 mm	50.000 hrs		10	20,08 €

** Consumer warranty only. Warranty conditions on page 258.

Reflector Light Bulbs PAR16

Very high color rendering
up to Ra 97
Perfect for home and
commercial applications
Full glass design



Reflector Light Bulb PAR16 Luxar,
page 45

Reflector Light Bulb PAR16 Genius 97

Highest color rendering, Ra 97
Full glass bulb with an elegant appearance
High dimmer compatibility

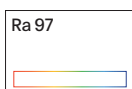
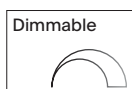

Product Code	Wattage	Watt Equiv.	Voltage	Base	Color Temp.	Luminous Flux	CRI	Dimmable	Angle	Diameter	Length	Lifespan	EEI	Unit	RRP*
5740401	3,9 W	35 W	230 V AC	GU10	2.700 K	280 lm	97	yes	36°	50 mm	54 mm	40.000 hrs	A G	10	7,14 €
5740501	3,9 W	35 W	230 V AC	GU10	3.000 K	280 lm	97	yes	36°	50 mm	54 mm	40.000 hrs	A G	10	7,14 €
5741001	5,5 W	50 W	230 V AC	GU10	2.700 K	375 lm	97	yes	24°	50 mm	54 mm	40.000 hrs	A G	10	7,98 €
5741301	5,5 W	50 W	230 V AC	GU10	2.700 K	375 lm	97	yes	36°	50 mm	54 mm	40.000 hrs	A G	10	7,98 €
5741101	5,5 W	50 W	230 V AC	GU10	3.000 K	375 lm	97	yes	24°	50 mm	54 mm	40.000 hrs	A G	10	7,98 €
5741401	5,5 W	50 W	230 V AC	GU10	3.000 K	375 lm	97	yes	36°	50 mm	54 mm	40.000 hrs	A G	10	7,98 €
5741501	5,5 W	50 W	230 V AC	GU10	4.000 K	375 lm	97	yes	36°	50 mm	54 mm	40.000 hrs	A G	10	7,98 €
5742201	9,3 W	75 W	230 V AC	GU10	2.700 K	575 lm	97	yes	36°	50 mm	52 mm	40.000 hrs	A G	10	13,87 €
5742301	9,3 W	75 W	230 V AC	GU10	3.000 K	575 lm	97	yes	36°	50 mm	52 mm	40.000 hrs	A G	10	13,87 €
5742401	9,3 W	75 W	230 V AC	GU10	4.000 K	575 lm	97	yes	36°	50 mm	52 mm	40.000 hrs	A G	10	13,87 €

CRI: 97,1

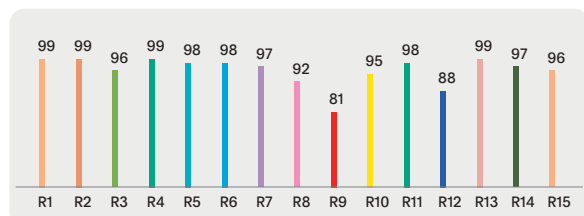

Reflector Light Bulb PAR16 Class A

Energy saving reflector light bulb for use in continuous lighting

Efficiency: 181 lm/W



Product Code	Wattage	Watt Equiv.	Voltage	Base	Color Temp.	Luminous Flux	CRI	Dimmable	Angle	Diameter	Length	Lifespan	EEL	Unit	RRP*
5730101	1,9 W	50 W	230 V AC	GU10	3.000 K	345 lm	80	no	36°	50 mm	54 mm	50.000 hrs	A	10	5,80 €

Reflector Light Bulb PAR16 Sunset

Dim-To-Warm technology

Bright version – up to 575 lumens

Full glass bulb with an elegant appearance

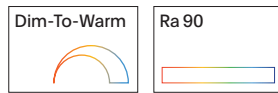

Product Code	Wattage	Watt Equiv.	Voltage	Base	Color Temp.	Luminous Flux	CRI	Dimmable	Angle	Diameter	Length	Lifespan	EEL	Unit	RRP*
5744501	3,8 W	50 W	230 V AC	GU10	2.700–2.200 K	345 lm	90	yes	36°	50 mm	54 mm	25.000 hrs	AP	10	7,14 €
5747701	6,7 W	75 W	230 V AC	GU10	2.700–2.200 K	575 lm	90	yes	36°	50 mm	54 mm	25.000 hrs	AP	10	10,00 €

Reflector Light Bulb PAR16 Luxar

High color rendering, Ra 90

Full glass bulb with an elegant appearance

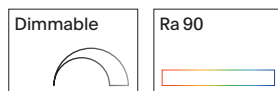

Product Code	Wattage	Watt Equiv.	Voltage	Base	Color Temp.	Luminous Flux	CRI	Dimmable	Angle	Diameter	Length	Lifespan	EEL	Unit	RRP*
Dimmable															
5752301	3,4 W	35 W	230 V AC	GU10	2.700 K	230 lm	90	yes	36°	50 mm	52 mm	25.000 hrs	AG	10	4,12 €
5752401	3,4 W	35 W	230 V AC	GU10	3.000 K	230 lm	90	yes	36°	50 mm	52 mm	25.000 hrs	AG	10	4,12 €
5752601	3,7 W	50 W	230 V AC	GU10	2.700 K	350 lm	90	yes	36°	50 mm	52 mm	25.000 hrs	AE	10	4,96 €
5752701	3,7 W	50 W	230 V AC	GU10	3.000 K	350 lm	90	yes	36°	50 mm	52 mm	25.000 hrs	AE	10	4,96 €
5752901	5 W	65 W	230 V AC	GU10	2.700 K	460 lm	90	yes	36°	50 mm	52 mm	25.000 hrs	AE	10	5,80 €
5754801	5 W	65 W	230 V AC	GU10	2.700 K	460 lm	90	yes	60°	50 mm	52 mm	25.000 hrs	AF	10	5,80 €
5753001	5 W	65 W	230 V AC	GU10	3.000 K	460 lm	90	yes	36°	50 mm	52 mm	25.000 hrs	AF	10	5,80 €
5755101	6 W	75 W	230 V AC	GU10	2.700 K	575 lm	90	yes	36°	50 mm	52 mm	25.000 hrs	AF	10	8,32 €
5755201	6 W	75 W	230 V AC	GU10	3.000 K	575 lm	90	yes	36°	50 mm	52 mm	25.000 hrs	AF	10	8,32 €
Not dimmable															
5756001	4 W	35 W	230 V AC	GU10	2.700 K	230 lm	90	no	36°	50 mm	52 mm	25.000 hrs	AG	10	2,44 €
5756301	4,7 W	50 W	230 V AC	GU10	2.700 K	345 lm	90	no	36°	50 mm	52 mm	25.000 hrs	AF	10	3,28 €
5756401	4,7 W	50 W	230 V AC	GU10	3.000 K	345 lm	90	no	36°	50 mm	52 mm	25.000 hrs	AF	10	3,28 €
5756601	6 W	65 W	230 V AC	GU10	2.700 K	460 lm	90	no	36°	50 mm	52 mm	25.000 hrs	AF	10	4,96 €
5756701	6 W	65 W	230 V AC	GU10	3.000 K	460 lm	90	no	36°	50 mm	52 mm	25.000 hrs	AF	10	4,96 €

Reflector Light Bulbs MR11/MR16

Modern LED technology with the look of a halogen bulb
Very high color rendering up to Ra 97



Reflector Light Bulb MR11 Luxar Glass



Dimmable



Product Code	Wattage	Watt Equiv.	Voltage	Base	Color Temp.	Luminous Flux	CRI	Dimmable	Angle	Diameter	Length	Lifespan	EEI	Unit	RRP*
5114201 New	2,3 W	20 W	12 V DC	GU4	2.700 K	184 lm	80	yes	36°	35 mm	38 mm	15.000 hrs		10	7,98 €
5114101	4,4 W	35 W	12 V DC	GU4	2.700 K	345 lm	80	yes	36°	35 mm	38 mm	25.000 hrs		10	9,66 €

Reflector Light Bulb MR16 Genius 97

Highest color rendering, Ra 97



Dimmable



Ra 97



Product Code	Wattage	Watt Equiv.	Voltage	Base	Color Temp.	Luminous Flux	CRI	Dimmable	Angle	Diameter	Length	Lifespan	EEI	Unit	RRP*
5142901	6,5 W	35 W	12 V DC	GU5,3	2.700 K	350 lm	97	yes	36°	51 mm	46 mm	40.000 hrs		10	11,34 €
5143301	7,8 W	45 W	12 V DC	GU5,3	2.700 K	480 lm	97	yes	36°	51 mm	46 mm	40.000 hrs		10	16,72 €

Reflector Light Bulb MR16 Luxar Glass



Dimmable



Ra 90



Product Code	Wattage	Watt Equiv.	Voltage	Base	Color Temp.	Luminous Flux	CRI	Dimmable	Angle	Diameter	Length	Lifespan	EEI	Unit	RRP*
5140301	5 W	35 W	12 V DC	GU5,3	2.700 K	345 lm	90	yes	36°	50 mm	44 mm	25.000 hrs		10	7,98 €
5140401	5 W	35 W	12 V DC	GU5,3	3.000 K	345 lm	90	yes	36°	50 mm	44 mm	25.000 hrs		10	7,98 €
5140601	5,2 W	40 W	12 V DC	GU5,3	2.700 K	460 lm	90	yes	36°	50 mm	44 mm	25.000 hrs		10	9,16 €
5140701	5,2 W	40 W	12 V DC	GU5,3	3.000 K	460 lm	90	yes	36°	50 mm	44 mm	25.000 hrs		10	9,16 €
5140801	6,8 W	50 W	12 V DC	GU5,3	2.700 K	621 lm	90	yes	36°	50 mm	44 mm	25.000 hrs		10	11,34 €
5140901 New	6,8 W	50 W	12 V DC	GU5,3	3.000 K	621 lm	90	yes	36°	50 mm	44 mm	25.000 hrs		10	11,34 €

Reflector Light Bulb MR16 Diled 95



Dimmable



Ra 95



Product Code	Wattage	Watt Equiv.	Voltage	Base	Color Temp.	Luminous Flux	CRI	Dimmable	Angle	Diameter	Length	Lifespan	EEI	Unit	RRP*
5144101	6 W	60 W	12 V DC	GU5,3	2.700 K	360 lm	95	yes	36°	51 mm	48 mm	40.000 hrs		10	25,13 €
5144201	6 W	60 W	12 V DC	GU5,3	3.000 K	360 lm	95	yes	36°	51 mm	48 mm	40.000 hrs		10	25,13 €

Recessed Spotlights

Swiveling recessed spotlights with an elegant appearance
Tool-free light bulb replacement without snap ring
Aluminum, powder-coated or matte polished



Recessed Spotlights 50 Round

Drill hole size: 68 mm diameter

Rotatable range: 25°

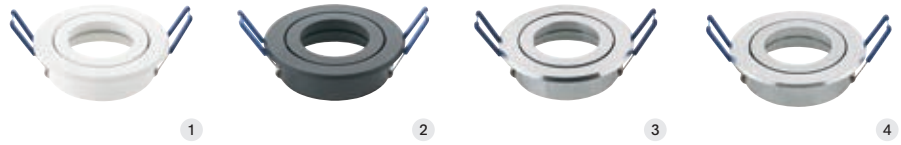

IP20

3

Years**

	Product Code	Style	Includes socket	Drill hole diameter	Outer diameter	RRP*
1	9861001	white	GU5,3	68 mm	83 mm	16,72 €
2	9861101	black	GU5,3	68 mm	83 mm	16,72 €
3	9861201	aluminum, polished	GU5,3	68 mm	83 mm	16,72 €
4	9861301	aluminum, brushed	GU5,3	68 mm	83 mm	16,72 €

Recessed Spotlights 50 Round, Recessed

Drill hole size: 68 mm diameter

Non-rotating



IP20

3

Years**

	Product Code	Style	Includes socket	Drill hole diameter	Outer diameter	RRP*
1	9861601	white	GU5,3	68 mm	82 mm	16,72 €
2	9861701	black	GU5,3	68 mm	82 mm	16,72 €

GU10 Socket with Spacer

Mounting depth 105 mm

IP20

3

Years**



Product Code	Style	RRP*
9870101	GU10	5,80 €

** Consumer warranty only. Warranty conditions on page 258.

Reflector Light Bulbs AR111/ES111

High-quality lens optics for objects and design
Very high color rendering up to Ra 95



Reflector Light Bulb AR111 Argent

Completely glare-free optics
For direct connection to 12 V transformers



Product Code	Wattage	Watt Equiv.	Voltage	Base	Color Temp.	Luminous Flux	CRI	Dimmable	Angle	Diameter	Length	Lifespan	EEI	Unit	RRP*
5787901	12 W	75 W	12 V DC	G53	2.700 K	800 lm	90	yes	10°	111 mm	67 mm	25.000 hrs		10	58,74 €
5788001	12 W	75 W	12 V DC	G53	2.700 K	800 lm	90	yes	19°	111 mm	67 mm	25.000 hrs		10	58,74 €
5788101	12 W	75 W	12 V DC	G53	2.700 K	800 lm	90	yes	35°	111 mm	67 mm	25.000 hrs		10	58,74 €

Reflector Light Bulb AR111 Luxar

For direct connection to 12 V transformers

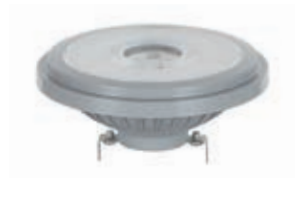

Product Code	Wattage	Watt Equiv.	Voltage	Base	Color Temp.	Luminous Flux	CRI	Dimmable	Angle	Diameter	Length	Lifespan	EEI	Unit	RRP*
5786301	7,4 W	65 W	12 V DC	G53	2.700 K	450 lm	95	yes	24°	111 mm	55 mm	40.000 hrs		6	14,20 €
5786401	7,4 W	65 W	12 V DC	G53	2.700 K	450 lm	95	yes	40°	111 mm	55 mm	40.000 hrs		6	14,20 €
5786601 New	11,7 W	75 W	12 V DC	G53	2.700 K	800 lm	97	yes	24°	111 mm	55 mm	40.000 hrs		6	15,88 €
5786701 New	11,7 W	75 W	12 V DC	G53	2.700 K	800 lm	97	yes	40°	111 mm	55 mm	40.000 hrs		6	15,88 €
5786501	13,5 W	100 W	12 V DC	G53	2.700 K	950 lm	95	yes	24°	111 mm	55 mm	40.000 hrs		6	20,08 €

Reflector Light Bulb ES111 Luxar

High quality lens optics
For direct connection to 230 V AC



Product Code	Wattage	Watt Equiv.	Voltage	Base	Color Temp.	Luminous Flux	CRI	Dimmable	Angle	Diameter	Length	Lifespan	EEI	Unit	RRP*
5749001	15 W	100 W	230 V AC	GU10	2.700 K	1.100 lm	90	yes	25°	111 mm	69 mm	15.000 hrs		6	20,08 €
5749101	15 W	100 W	230 V AC	GU10	3.000 K	1.100 lm	90	yes	25°	111 mm	69 mm	15.000 hrs		6	20,08 €
5749301	15 W	100 W	230 V AC	GU10	2.700 K	1.100 lm	90	yes	40°	111 mm	69 mm	15.000 hrs		6	20,08 €
5749401	15 W	100 W	230 V AC	GU10	3.000 K	1.100 lm	90	yes	40°	111 mm	69 mm	15.000 hrs		6	20,08 €

Pin Base Light Bulbs

Compact light bulbs with high output



Pin Base Light Bulb G9, Dimmable

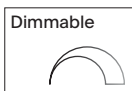

Product Code	Wattage	Watt Equiv.	Voltage	Base	Color Temp.	Luminous Flux	CRI	Dimmable	Diameter	Length	Lifespan	EEL	Unit	RRP*
5759201	3,2 W	32 W	230 V AC	G9	2.700 K	350 lm	80	yes	18 mm	59 mm	15.000 hrs		10	10,00 €
5759101	4 W	40 W	230 V AC	G9	2.700 K	480 lm	80	yes	18 mm	59 mm	15.000 hrs		10	12,18 €
5753101	5 W	48 W	230 V AC	G9	2.700 K	550 lm	80	yes	18 mm	59 mm	15.000 hrs		10	13,87 €

New. Pin Base Light Bulb G9



Product Code	Wattage	Watt Equiv.	Voltage	Base	Color Temp.	Luminous Flux	CRI	Dimmable	Diameter	Length	Lifespan	EEL	Unit	RRP*
5758501	3,7 W	40 W	230 V AC	G9	2.700 K	470 lm	80	no	16 mm	52 mm	15.000 hrs		10	9,66 €
5758601	4,8 W	48 W	230 V AC	G9	2.700 K	600 lm	80	no	17 mm	55 mm	15.000 hrs		10	11,34 €
5758701	4,9 W	60 W	230 V AC	G9	2.700 K	806 lm	80	no	18 mm	59 mm	15.000 hrs		10	14,71 €

Pin Base Light Bulb G4/GY6,35



Product Code	Wattage	Watt Equiv.	Voltage	Base	Color Temp.	Luminous Flux	CRI	Dimmable	Diameter	Length	Lifespan	EEL	Unit	RRP*
G4														
1 5754101	1 W	10 W	12 V DC	G4	2.700 K	100 lm	80	no	10 mm	30 mm	15.000 hrs		10	5,46 €
1 5754201	1,5 W	19 W	12 V DC	G4	2.700 K	180 lm	80	no	14 mm	40 mm	15.000 hrs		10	5,80 €
1 5754301	2,8 W	30 W	12 V DC	G4	2.700 K	300 lm	80	no	14 mm	40 mm	15.000 hrs		10	7,14 €
2 5754401	4 W	40 W	12 V DC	G4	2.700 K	470 lm	80	no	18 mm	50 mm	15.000 hrs		10	9,16 €
GY6,35														
3 5750901	2,6 W	30 W	12 V DC	GY6,35	2.700 K	300 lm	80	no	14 mm	36 mm	15.000 hrs		10	7,14 €
3 5754701	4 W	40 W	12 V DC	GY6,35	2.700 K	470 lm	80	no	18 mm	50 mm	15.000 hrs		10	9,16 €

Light Bulbs R7s

Up to 360° omnidirectional lumination
Bright version up to 1.521 lumens



New. Light Bulb R7s COB Slim, 78 mm

Dimmable



Product Code	Wattage	Watt Equiv.	Voltage	Base	Color Temp.	Luminous Flux	CRI	Dimmable	Diameter	Length	Lifespan	EEL	Unit	RRP*
5755501	4,2 W	40 W	230 V AC	R7s	2.700 K	470 lm	80	yes	16 mm	78 mm	20.000 hrs		10	16,72 €

Light Bulb R7s Slim, 78 mm



Product Code	Wattage	Watt Equiv.	Voltage	Base	Color Temp.	Luminous Flux	CRI	Dimmable	Diameter	Length	Lifespan	EEL	Unit	RRP*
5788901	5 W	53 W	230 V AC	R7s	2.700 K	680 lm	80	no	16 mm	78 mm	20.000 hrs		10	9,16 €
5755301	7 W	60 W	230 V AC	R7s	2.700 K	806 lm	80	no	20 mm	78 mm	15.000 hrs		10	11,68 €

New. Light Bulb R7s COB Slim, 117 mm

Dimmable



Product Code	Wattage	Watt Equiv.	Voltage	Base	Color Temp.	Luminous Flux	CRI	Dimmable	Diameter	Length	Lifespan	EEL	Unit	RRP*
5755701	9 W	75 W	230 V AC	R7s	2.700 K	1.050 lm	80	yes	20 mm	117 mm	15.000 hrs		10	25,13 €
5755801	10,5 W	100 W	230 V AC	R7s	2.700 K	1.521 lm	80	no	18 mm	117 mm	15.000 hrs		10	23,45 €

Light Bulb R7s Luxar Slim, 117 mm



Product Code	Wattage	Watt Equiv.	Voltage	Base	Color Temp.	Luminous Flux	CRI	Dimmable	Diameter	Length	Lifespan	EEL	Unit	RRP*
5789601	8 W	75 W	230 V AC	R7s	2.700 K	1.080 lm	80	no	16 mm	117 mm	20.000 hrs		10	15,88 €

Linear Lamps

Made entirely of glass and featuring high-quality, anodized fittings, this classic linear lamp is appealing in every respect—both as a mirror light and as decorative lighting. The clear version is easy on the eyes and also a visual highlight, while the opal version provides uniform, shadow-free illumination. The extra warm color ensures a cozy ambience.



Linear Lamp, Clear

Full glass design
Pleasant, extra warm light color 2.200 K
Dimmable

Linear Lamp Glass S14d, Clear

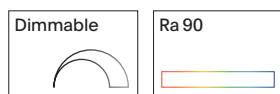

Product Code	Wattage	Watt Equiv.	Voltage	Base	Color Temp.	Luminous Flux	CRI	Dimmable	Diameter	Length	Lifespan	EEL	Unit	RRP*
5948001	4 W	30 W	230 V AC	S14d	2.200 K	280 lm	90	yes	30 mm	300 mm	15.000 hrs		10	31,85 €
5948301	5 W	40 W	230 V AC	S14d	2.200 K	380 lm	90	yes	30 mm	500 mm	15.000 hrs		10	39,92 €

Linear Lamp Glass S14s, Clear



Product Code	Wattage	Watt Equiv.	Voltage	Base	Color Temp.	Luminous Flux	CRI	Dimmable	Diameter	Length	Lifespan	EEL	Unit	RRP*
5947001	4 W	30 W	230 V AC	S14s	2.200 K	280 lm	90	yes	30 mm	300 mm	15.000 hrs		10	31,85 €
5947301	5 W	40 W	230 V AC	S14s	2.200 K	380 lm	90	yes	30 mm	500 mm	15.000 hrs		10	39,92 €
5947601	6 W	45 W	230 V AC	S14s	2.200 K	500 lm	90	yes	30 mm	1.000 mm	15.000 hrs		10	79,75 €

Linear Lamp, Opal

Full glass design
Shadow-free illumination
Dimmable



Linear Lamp Glass S14d, Opal

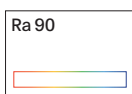
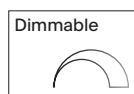

Product Code	Wattage	Watt Equiv.	Voltage	Base	Color Temp.	Luminous Flux	CRI	Dimmable	Diameter	Length	Lifespan	EEL	Unit	RRP*
5948101	6 W	40 W	230 V AC	S14d	2.700 K	470 lm	90	yes	30 mm	300 mm	15.000 hrs		10	39,92 €
5948401	7 W	50 W	230 V AC	S14d	2.700 K	560 lm	90	yes	30 mm	500 mm	15.000 hrs		10	50,00 €

Linear Lamp Glass S14s, Opal

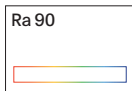
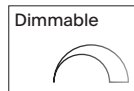

Product Code	Wattage	Watt Equiv.	Voltage	Base	Color Temp.	Luminous Flux	CRI	Dimmable	Diameter	Length	Lifespan	EEL	Unit	RRP*
5947101	6 W	40 W	230 V AC	S14d	2.700 K	470 lm	90	yes	30 mm	300 mm	15.000 hrs		10	39,92 €
5947401	7 W	50 W	230 V AC	S14d	2.700 K	570 lm	90	yes	30 mm	500 mm	15.000 hrs		10	50,00 €

Linear Lamp – Accessories

Wall Lamp Socket for S14d Base

	Product Code	Color	Base	max. Watt	Dimensions (L x W x H)	RRP*
1	9876001	black	S14d	60 W	65 x 40 x 35 mm	8,32 €
2	9876101	white	S14d	60 W	65 x 40 x 35 mm	8,32 €
3	9876501	nickel-colored	S14d	60 W	65 x 40 x 35 mm	8,32 €

1



2



3



Tubes

For direct use with lamps using magnetic ballasts
Not suitable for use with electronic ballasts

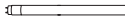

Tube Instant-Pro

Bright version for project and commercial applications



3

Years**



Product Code	Wattage	Voltage	Base	Color Temp.	Luminous Flux	Ballast	CRI	Dimmable	Angle	Diameter	Length	Lifespan	EEL	Unit	RRP*
5833501	17,5 W	230 V AC	G13	830/3.000 K	2.600 lm	Conventional	80	no	250°	28 mm	1.200 mm	25.000 hrs		25	12,18 €
5833601	17,5 W	230 V AC	G13	840/4.000 K	2.600 lm	Conventional	80	no	250°	28 mm	1.200 mm	25.000 hrs		25	12,18 €
5834001	22 W	230 V AC	G13	830/3.000 K	3.300 lm	Conventional	80	no	250°	28 mm	1.500 mm	25.000 hrs		25	15,88 €
5834101	22 W	230 V AC	G13	840/4.000 K	3.300 lm	Conventional	80	no	250°	28 mm	1.500 mm	25.000 hrs		25	15,88 €

** Consumer warranty only. Warranty conditions on page 258.

Light Strips COB

—
Homogeneous light
→ p. 60



Light Strips Art Omni

—
Artful, three-directional
illumination
→ p. 87



Light Strips Vario Cut

—
Your desired length
with no additional costs
→ p. 68



Light Strips
Tunable White

—
Freely tunable
color temperature
→ p. 76

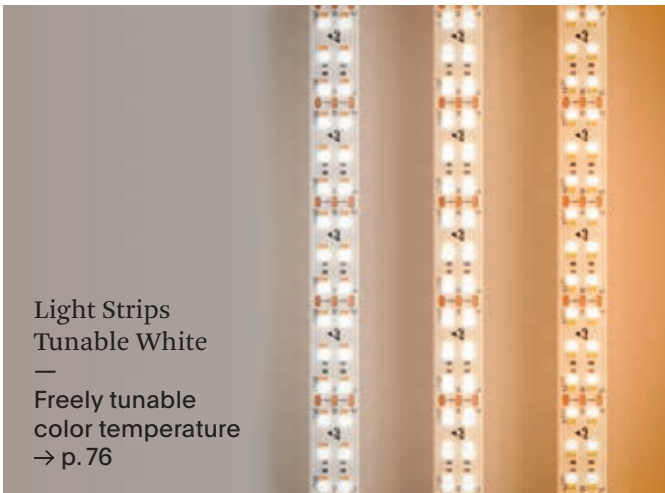

Light Strips Dim-To-Warm

—
Automatic reduction of
color temperature when dimming
→ p. 74

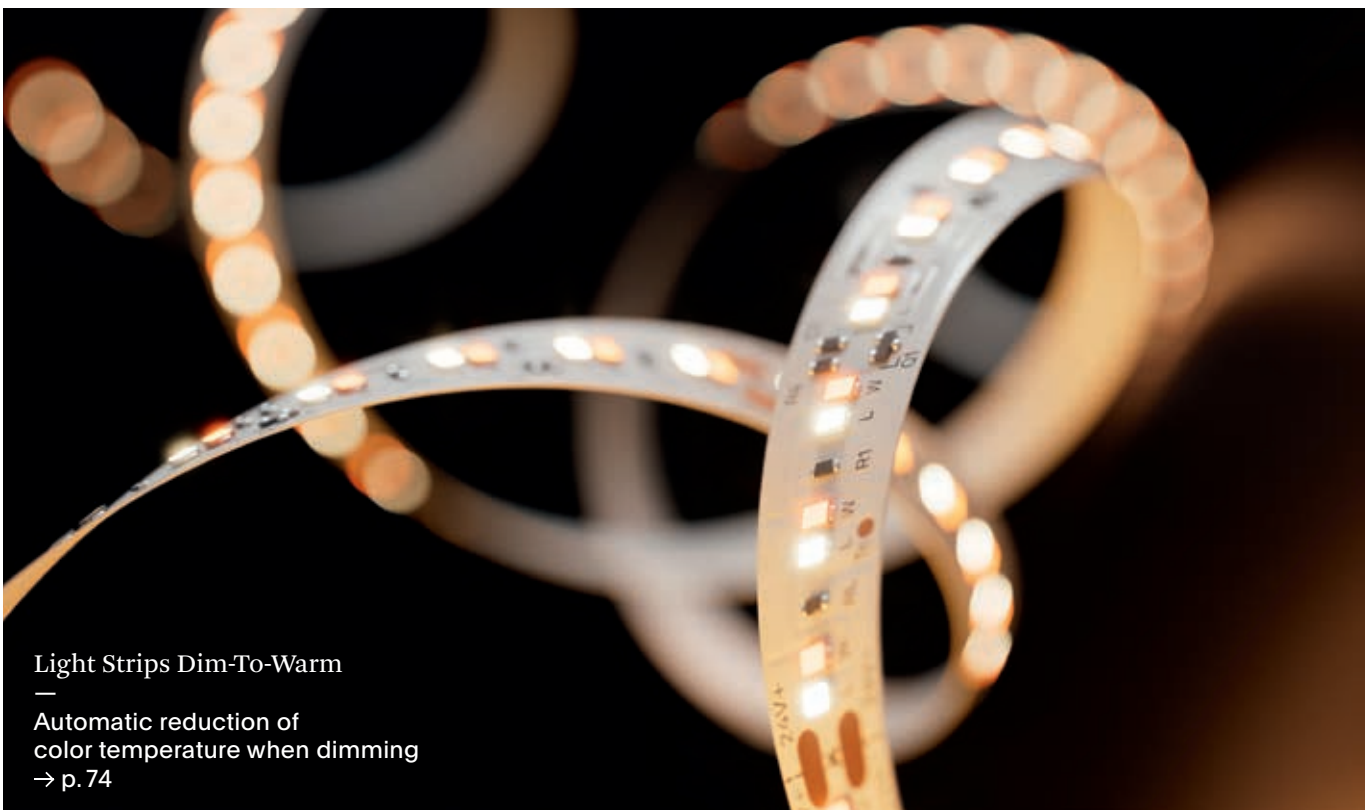

Light Strips Flexible Applications High Quality Emotional Effect

Atmosphere at its finest. With their fine, uniform light points, our light strips create mood-enhancing accents exactly where you need them. Warm white, neutral white, or colored—in various brightness levels, lengths, and designs, you'll find exactly the strip that suits your style. For light that adds warmth, depth, and personality to the room.



Light Strips COB, Single Color
p. 60



Light Strips CSP
p. 63



Light Strips Nature
p. 64



Light Strips Pro
p. 66



Light Strips Vario Cut
p. 68



Light Strips Long Distance
p. 70

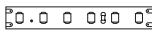

Light Strips Slim
p. 72



Light Strips Dim-To-Warm
p. 74

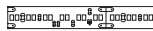

Light Strips Tunable White
p. 76



Light Strips Color
p. 78



Light Strips High Temperature
IP65 / IP67
p. 82



Light Strips IP67, Single Color
p. 83



Light Strips IP67, Multicolor
p. 84



Light Strips IP68
p. 85



Light Strips Art
p. 86

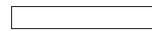

Luxi Link Light Track
p. 94



Light Strips High Voltage
p. 96

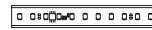

Customization
p. 100



Light Strips COB, Single Color

Homogeneous light without shadows.
 Our COB light strips provide a balanced, even lighting without individual points of light. Ideal for flowing lighting effects, elegant accents, and high-quality lighting installations where uniformity and high light quality are key.



Color spectrum

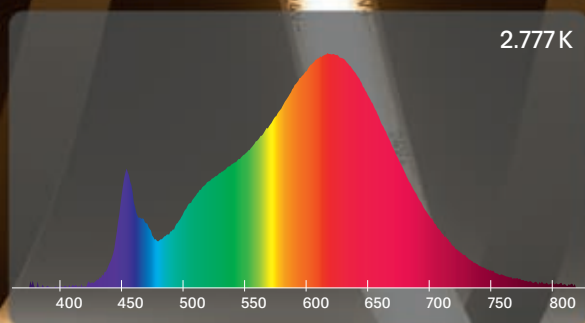

CRI: 92,6

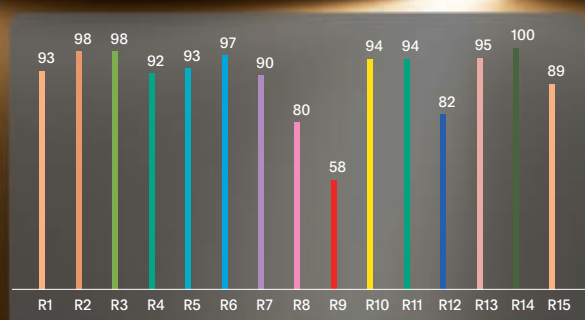

Tested product: COB Freecut 15 W/m - 5913701
 The measured data are average values and represent the product group as an example.

New. Light Strip COB Freecut 5 W/m

No light dots visible thanks to the continuous phosphor layer
 Can be separated anywhere along its entire length
 Perfect for flat LED profiles

24	546	1	3	54.000 hrs	5
V DC	LED/m	BIN	SDCM	L70/B10	Years**



Product Code	Reel Length	Color Temp.	Luminous Flux/m	Angle	CRI	t _c max.	t _g max.	Max. Op. Length	IP	EEL	RRP*
5913001	5 m	2.200 K	300 lm	180°	90	50 °C	45 °C	5 m	IP00		60,08 €
5913101	5 m	2.700 K	330 lm	180°	90	50 °C	45 °C	5 m	IP00		60,08 €
5913201	5 m	3.000 K	360 lm	180°	90	50 °C	45 °C	5 m	IP00		60,08 €

New. Light Strip COB Freecut 10 W/m

No light dots visible thanks to the continuous phosphor layer
 Can be separated anywhere along its entire length
 Perfect for flat LED profiles

24	546	1	3	54.000 hrs	5
V DC	LED/m	BIN	SDCM	L70/B10	Years**



Product Code	Reel Length	Color Temp.	Luminous Flux/m	Angle	CRI	t _c max.	t _g max.	Max. Op. Length	IP	EEL	RRP*
5913301	5 m	2.200 K	600 lm	180°	90	55 °C	45 °C	5 m	IP00		70,17 €
5913401	5 m	2.700 K	660 lm	180°	90	55 °C	45 °C	5 m	IP00		70,17 €
5913501	5 m	3.000 K	720 lm	180°	90	55 °C	45 °C	5 m	IP00		70,17 €

New. Light Strip COB Freecut 15 W/m

Requires an aluminum profile
 No light dots visible thanks to the continuous phosphor layer
 Can be separated anywhere along its entire length
 Perfect for flat LED profiles

24	546	1	3	54.000 hrs	5
V DC	LED/m	BIN	SDCM	L70/B10	Years**



Product Code	Reel Length	Color Temp.	Luminous Flux/m	Angle	CRI	t _c max.	t _g max.	Max. Op. Length	IP	EEL	RRP*
5913601	5 m	2.200 K	900 lm	180°	90	65 °C	45 °C	5 m	IP00		80,25 €
5913701	5 m	2.700 K	1.000 lm	180°	90	65 °C	45 °C	5 m	IP00		80,25 €
5913801	5 m	3.000 K	1.100 lm	180°	90	65 °C	45 °C	5 m	IP00		80,25 €
5913901	5 m	4.000 K	1.200 lm	180°	90	65 °C	45 °C	5 m	IP00		80,25 €

New. Light Strip COB Freecut 16 W/m

Requires an aluminum profile
 No light dots visible thanks to the continuous phosphor layer
 Can be separated anywhere along its entire length
 Perfect for flat LED profiles

24	546	1	3	54.000 hrs	5
V DC	LED/m	BIN	SDCM	L70/B10	Years**



Product Code	Reel Length	Color Temp.	Luminous Flux/m	Angle	CRI	t _c max.	t _g max.	Max. Op. Length	IP	EEL	RRP*
5914001	5 m	2.700 K	1.200 lm	180°	80	65 °C	45 °C	5 m	IP00		90,67 €
5914101	5 m	3.000 K	1.340 lm	180°	80	65 °C	45 °C	5 m	IP00		90,67 €
5914201	5 m	4.000 K	1.500 lm	180°	80	65 °C	45 °C	5 m	IP00		90,67 €

Insufficient cooling can damage the LED strip and shorten its service life significantly.
 ** Consumer warranty only. Warranty conditions on page 258.

Light Strip COB R2R 10 W/m

No solder joints after 500 mm thanks to the reel-to-reel production process

24	480	5	54.000 hrs	3
V DC	LED/m	SDCM	L80/B10	Years**



Product Code	Reel Length	Color Temp.	Luminous Flux/m	Angle	CRI	t _c max.	t _s max.	Max. Op. Length	IP	EEL	RRP*
5955601	5 m $\frac{1}{cm}$	2.700 K	900 lm	180°	90	65 °C	60 °C	5 m	IP00		70,17 €
5955701	5 m $\frac{1}{cm}$	3.000 K	950 lm	180°	90	65 °C	60 °C	5 m	IP00		70,17 €

Light Strip COB Spot 10 W/m

Targeted 120° light output

24	512	1	5	36.000 hrs	3
V DC	LED/m	BIN	SDCM	L80/B10	Years**

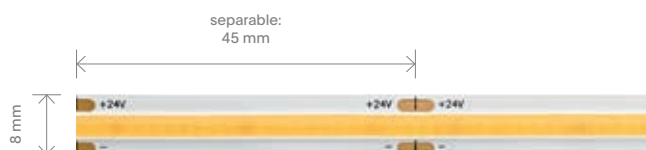

Product Code	Reel Length	Color Temp.	Luminous Flux/m	Angle	CRI	t _c max.	t _s max.	Max. Op. Length	IP	EEL	RRP*
5921401	5 m $\frac{1}{cm}$	2.700 K	950 lm	120°	90	80 °C	70 °C	5 m	IP00		121,76 €
5921501	5 m $\frac{1}{cm}$	3.000 K	1.000 lm	120°	90	80 °C	70 °C	5 m	IP00		121,76 €

COB Feed-ins

Suitable for single color light strips with high chip density and COB light strips

Application example
COB Feed-in



Feed-in
Strip type: single color



Product Code	Strip Width	RRP*
9711001	8 mm	2,10 €
9711101	10 mm	2,10 €

Wired Strip to Strip Connector
Strip type: single color



Product Code	Strip Width	RRP*
9711501	8 mm	3,28 €
9711601	10 mm	3,28 €

Direct Connector
Strip type: single color



Product Code	Strip Width	RRP*
9711201	8 mm	1,26 €
9711301	10 mm	1,26 €

Insufficient cooling can damage the LED strip and shorten its service life significantly.
** Consumer warranty only. Warranty conditions on page 258.

Light Strips CSP

Our CSP light strips feature a particularly long lifespan compared to conventional COB strips and homogeneous illumination with white coating.

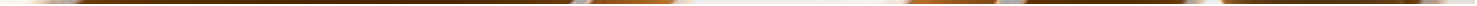
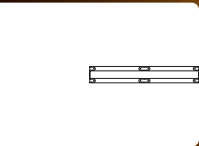

Light Strip CSP 10 W/m, Single Color

Requires an aluminum profile
Homogeneous light pattern
Highly flexible thanks to white phosphorus bonding
No soldering points

24	320	3	72.000 hrs	5
V DC	LED/m	SDCM	L80/B10	Years**

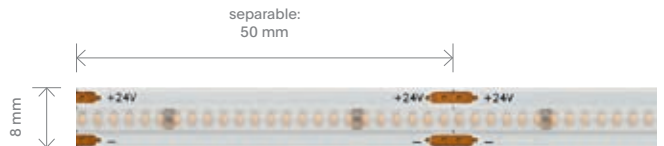

Product Code	Reel Length	Color Temp.	Luminous Flux/m	Angle	CRI	t _c max.	t _s max.	Max. Op. Length	IP	EEL	RRP*
5922001	5 m $\frac{1}{cm}$	2.700 K	970 lm	150°	90	75 °C	65 °C	5 m	IP00		99,92 €
5922101	5 m $\frac{1}{cm}$	3.000 K	1.010 lm	150°	90	75 °C	65 °C	5 m	IP00		99,92 €
5922201	5 m $\frac{1}{cm}$	4.000 K	1.036 lm	150°	90	75 °C	65 °C	5 m	IP00		99,92 €

Light Strip CSP 14,4 W/m, Single Color

Requires an aluminum profile
Homogeneous light pattern
Highly flexible thanks to white phosphorus bonding
No soldering points

24	480	3	72.000 hrs	5
V DC	LED/m	SDCM	L80/B10	Years**

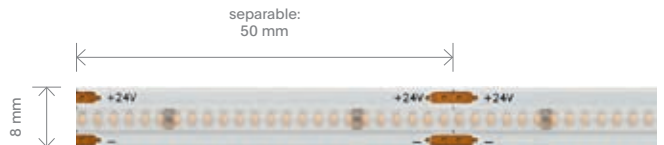

Product Code	Reel Length	Color Temp.	Luminous Flux/m	Angle	CRI	t _c max.	t _s max.	Max. Op. Length	IP	EEL	RRP*
5922301	5 m $\frac{1}{cm}$	2.700 K	1.300 lm	150°	90	75 °C	65 °C	5 m	IP00		129,83 €
5922401	5 m $\frac{1}{cm}$	3.000 K	1.330 lm	150°	90	75 °C	65 °C	5 m	IP00		129,83 €
5922501	5 m $\frac{1}{cm}$	4.000 K	1.360 lm	150°	90	75 °C	65 °C	5 m	IP00		129,83 €

Insufficient cooling can damage the LED strip and shorten its service life significantly.
** Consumer warranty only. Warranty conditions on page 258.

Light Strips Nature

Brilliant color rendering and high efficiency. Our Nature light strips impress with brilliant color rendering ($Ra > 96$) making colors appear vivid and natural. At the same time, they offer high energy efficiency for first-class light with low consumption.



CRI: 96.5

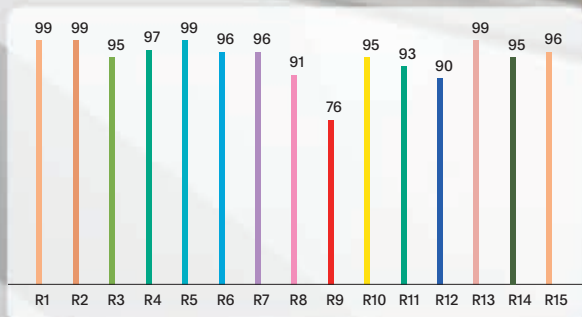

Color spectrum

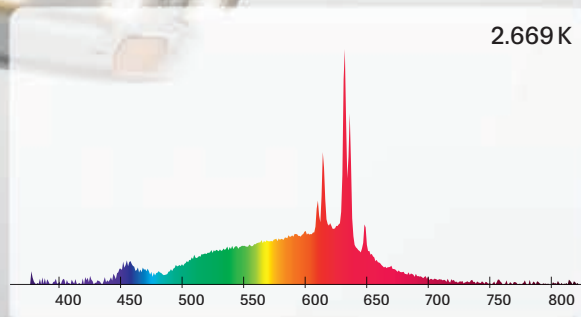

Tested product: Nature 21,6 W/m – 5926601
The measured data are average values and represent the product group as an example.

Light Strip Nature 9,6 W/m

—
 Brilliant color rendering with Ra > 96
 High light output and excellent efficiency
 Perfect for sophisticated color and design applications

24	128	1	5	54.000 hrs	3
V DC	LED/m	BIN	SDCM	L80/B10	Years**



Product Code	Reel Length	Color Temp.	Luminous Flux/m	Angle	CRI	t _c max.	t _g max.	Max. Op. Length	IP	EEL	RRP*
5926001	5 m $\frac{1}{cm}$	2.700 K	1.668 lm	120°	96	85 °C	80 °C	5 m	IP00	A C	109,16 €
5926101	5 m $\frac{1}{cm}$	3.000 K	1.660 lm	120°	96	85 °C	80 °C	5 m	IP00	A C	109,16 €
5926201	5 m $\frac{1}{cm}$	4.000 K	1.731 lm	120°	96	85 °C	80 °C	5 m	IP00	A C	109,16 €

Light Strip Nature 14,4 W/m

—
 Requires an aluminum profile
 Brilliant color rendering with Ra > 96
 High light output and excellent efficiency
 Perfect for sophisticated color and design applications

24	160	1	5	54.000 hrs	3
V DC	LED/m	BIN	SDCM	L80/B10	Years**



Product Code	Reel Length	Color Temp.	Luminous Flux/m	Angle	CRI	t _c max.	t _g max.	Max. Op. Length	IP	EEL	RRP*
5926301	5 m $\frac{1}{cm}$	2.700 K	2.395 lm	120°	96	85 °C	80 °C	5 m	IP00	A D	151,18 €
5926401	5 m $\frac{1}{cm}$	3.000 K	2.433 lm	120°	96	85 °C	80 °C	5 m	IP00	A D	151,18 €
5926501	5 m $\frac{1}{cm}$	4.000 K	2.538 lm	120°	96	85 °C	80 °C	5 m	IP00	A C	151,18 €

Light Strip Nature 21,6 W/m

—
 Requires an aluminum profile
 Brilliant color rendering with Ra > 96
 High light output and excellent efficiency
 Perfect for sophisticated color and design applications

24	240	1	5	54.000 hrs	3
V DC	LED/m	BIN	SDCM	L80/B10	Years**



Product Code	Reel Length	Color Temp.	Luminous Flux/m	Angle	CRI	t _c max.	t _g max.	Max. Op. Length	IP	EEL	RRP*
5926601	3,5 m $\frac{1}{cm}$	2.700 K	3.616 lm	120°	96	85 °C	80 °C	3,5 m	IP00	A D	188,99 €
5926701	3,5 m $\frac{1}{cm}$	3.000 K	3.671 lm	120°	96	85 °C	80 °C	3,5 m	IP00	A D	188,99 €
5926801	3,5 m $\frac{1}{cm}$	4.000 K	3.890 lm	120°	96	85 °C	80 °C	3,5 m	IP00	A C	188,99 €

Insufficient cooling can damage the LED strip and shorten its service life significantly.
 ** Consumer warranty only. Warranty conditions on page 258.

Light Strips Pro

Reliable quality for your project. Our Pro light strips offer established technology, versatile application options, and a balanced cost-performance ratio.

Tested product: Pro 9,6 W/m - 5934301
The measured data are average values and represent the product group as an example.

CRI: 92,3

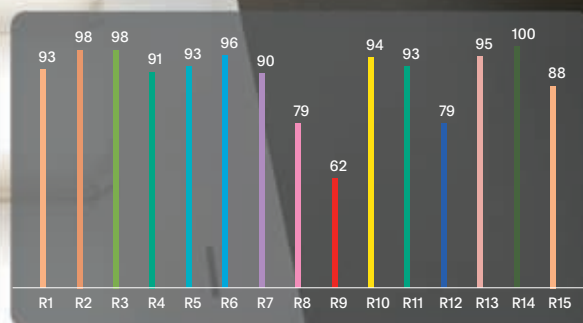

Color spectrum

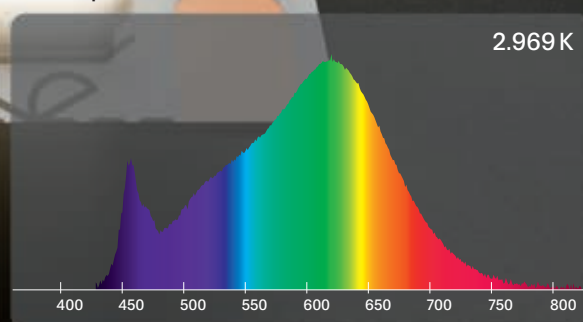

Light Strip Pro 9,6 W/m

High light quality with Ra 90
Established technology for versatile applications

24	128	1	3	54.000 hrs	5
V DC	LED/m	BIN	SDCM	L70/B10	Years**

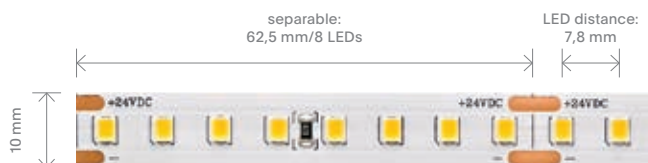

Product Code	Reel Length	Color Temp.	Luminous Flux/m	Angle	CRI	t _c max.	t _s max.	Max. Op. Length	IP	EEL	RRP*
5934201	5 m $\frac{1}{cm}$	2.700 K	1.432 lm	120°	90	85 °C	80 °C	5 m	IP00		60,08 €
5934301	5 m $\frac{1}{cm}$	3.000 K	1.440 lm	120°	90	85 °C	80 °C	5 m	IP00		60,08 €
5934401	5 m $\frac{1}{cm}$	4.000 K	1.447 lm	120°	90	85 °C	80 °C	5 m	IP00		60,08 €

Light Strip Pro 14,4 W/m

Requires an aluminum profile
High light quality with Ra 90
Established technology for versatile applications

24	160	1	3	54.000 hrs	5
V DC	LED/m	BIN	SDCM	L70/B10	Years**



Product Code	Reel Length	Color Temp.	Luminous Flux/m	Angle	CRI	t _c max.	t _s max.	Max. Op. Length	IP	EEL	RRP*
5934501	5 m $\frac{1}{cm}$	2.700 K	2.117 lm	120°	90	85 °C	80 °C	5 m	IP00		70,17 €
5934601	5 m $\frac{1}{cm}$	3.000 K	2.079 lm	120°	90	85 °C	80 °C	5 m	IP00		70,17 €
5934701	5 m $\frac{1}{cm}$	4.000 K	2.275 lm	120°	90	85 °C	80 °C	5 m	IP00		70,17 €

Light Strip Pro 18 W/m

Requires an aluminum profile
High light quality with Ra 90
Established technology for versatile applications

24	192	1	3	54.000 hrs	5
V DC	LED/m	BIN	SDCM	L70/B10	Years**



Product Code	Reel Length	Color Temp.	Luminous Flux/m	Angle	CRI	t _c max.	t _s max.	Max. Op. Length	IP	EEL	RRP*
5934801	5 m $\frac{1}{cm}$	2.700 K	2.585 lm	120°	90	85 °C	80 °C	5 m	IP00		88,15 €
5934901	5 m $\frac{1}{cm}$	3.000 K	2.607 lm	120°	90	85 °C	80 °C	5 m	IP00		88,15 €
5935001	5 m $\frac{1}{cm}$	4.000 K	2.714 lm	120°	90	85 °C	80 °C	5 m	IP00		88,15 €

Light Strip Pro 21,6 W/m

Requires an aluminum profile
High light quality with Ra 90
Established technology for versatile applications

24	240	1	3	54.000 hrs	5
V DC	LED/m	BIN	SDCM	L70/B10	Years**



Product Code	Reel Length	Color Temp.	Luminous Flux/m	Angle	CRI	t _c max.	t _s max.	Max. Op. Length	IP	EEL	RRP*
5935101	5 m $\frac{1}{cm}$	2.700 K	3.075 lm	120°	90	85 °C	80 °C	4 m	IP00		100,76 €
5935201	5 m $\frac{1}{cm}$	3.000 K	3.358 lm	120°	90	85 °C	80 °C	4 m	IP00		100,76 €
5935301	5 m $\frac{1}{cm}$	4.000 K	3.461 lm	120°	90	85 °C	80 °C	4 m	IP00		100,76 €

Insufficient cooling can damage the LED strip and shorten its service life significantly.
** Consumer warranty only. Warranty conditions on page 258.

Light Strips Vario Cut

Design lighting to suit your requirements – our Vario Cut light strips adapt perfectly to your project. Special lengths and your desired dimensions at no extra charge. For lighting that is as individual as your ideas.



Your desired length with no additional costs

Light strips with the Vario Cut length designation can be ordered in lengths between 1 m and the specified maximum length.

The unit of measurement is meters instead of pieces. The light strips are cut to length by the meter at no extra charge. They are delivered without feed-in.

Connectors and special lengths can be customized as well (see chapter Customization, pages 100–101).

CRI: 91,7



Color spectrum

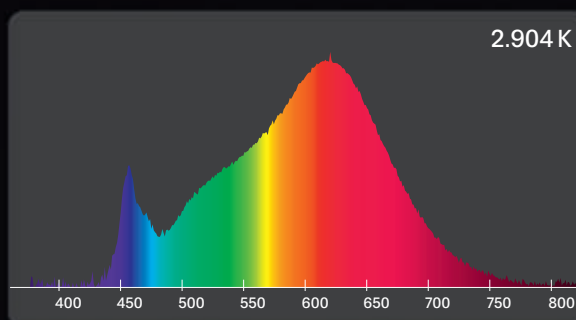

Tested product: Vario Cut 9,6 W/m – 5838401
The measured data are average values and represent the product group as an example.

Light Strip Vario Cut 7,2 W/m

Your desired length with no additional costs from 1 m
Cut to length by the meter
Perfect for custom light installations

24	120	1	5	54.000 hrs	5
V DC	LED/m	BIN	SDCM	L70/B10	Years**



Product Code	Vario Cut	Color Temp.	Luminous Flux/m	Angle	CRI	t _c max.	t _g max.	Max. Op. Length	IP	EEL	RRP/m*
5838001	1-20 m	2.700 K	620 lm	120°	90	75 °C	45 °C	20 m	IP00		12,18 €
5838101	1-20 m	3.000 K	634 lm	120°	90	75 °C	45 °C	20 m	IP00		12,18 €
5838201	1-20 m	4.000 K	676 lm	120°	90	75 °C	45 °C	20 m	IP00		12,18 €

Light Strip Vario Cut 9,6 W/m

Your desired length with no additional costs from 1 m
Cut to length by the meter
Perfect for custom light installations

24	120	1	5	54.000 hrs	5
V DC	LED/m	BIN	SDCM	L70/B10	Years**



Product Code	Vario Cut	Color Temp.	Luminous Flux/m	Angle	CRI	t _c max.	t _g max.	Max. Op. Length	IP	EEL	RRP/m*
5838301	1-10 m	2.700 K	864 lm	120°	90	75 °C	45 °C	10 m	IP00		15,88 €
5838401	1-10 m	3.000 K	845 lm	120°	90	75 °C	45 °C	10 m	IP00		15,88 €
5838501	1-10 m	4.000 K	883 lm	120°	90	75 °C	45 °C	10 m	IP00		15,88 €

Light Strip Vario Cut 14,4 W/m

Requires an aluminum profile
Your desired length with no additional costs from 1 m
Cut to length by the meter
Perfect for custom light installations

24	120	1	5	52.000 hrs	5
V DC	LED/m	BIN	SDCM	L70/B10	Years**



Product Code	Vario Cut	Color Temp.	Luminous Flux/m	Angle	CRI	t _c max.	t _g max.	Max. Op. Length	IP	EEL	RRP/m*
5838601	1-10 m	2.700 K	1.411 lm	120°	90	75 °C	45 °C	10 m	IP00		20,08 €
5838701	1-10 m	3.000 K	1.440 lm	120°	90	75 °C	45 °C	10 m	IP00		20,08 €
5838801	1-10 m	4.000 K	1.512 lm	120°	90	75 °C	45 °C	10 m	IP00		20,08 €

Insufficient cooling can damage the LED strip and shorten its service life significantly.
** Consumer warranty only. Warranty conditions on page 258.

Light Strips Long Distance

Suitable and reliable for long distances.
Our Long Distance light strips are designed for optimum function at up to 20 m per connection.
Despite their length, they guarantee even brightness and stable output.

0.0 0 0 0 0 0

Color spectrum

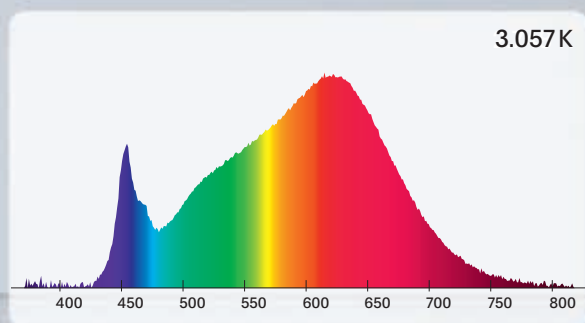

CRI: 94,6

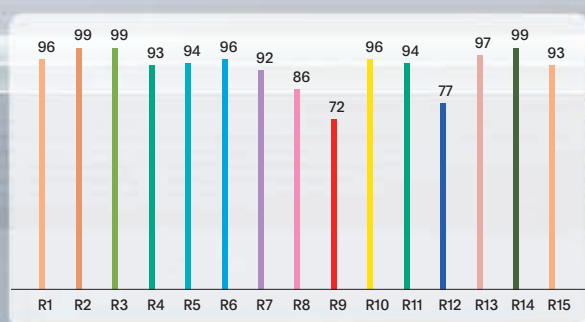





Tested product: Long Distance 9,6 W/m -5924,301
The measured data are average values and represent the product group as an example.

Light Strip Long Distance COB 7 W/m

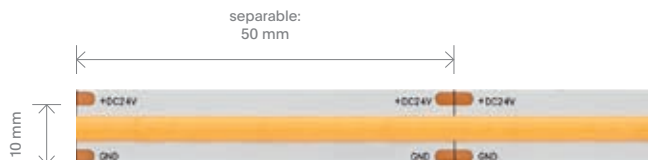
13 m with single feed-in
Homogeneous illumination
The perfect choice for big areas and installations

24	360	1	54.000 hrs	3	13 m
V DC	LED/m	BIN	L70/B10	Years**	





Product Code	Reel Length	Color Temp.	Luminous Flux/m	Angle	CRI	t _c max.	t _s max.	Max. Op. Length	IP	EEL	RRP*
5837001	13 m 	2.700 K	490 lm	180°	90	65 °C	60 °C	13 m	IP00		159,58 €
5837101	13 m 	3.000 K	525 lm	180°	90	65 °C	60 °C	13 m	IP00		159,58 €

Light Strips Long Distance 9,6 W/m

20 m with single feed-in
The perfect choice for big areas and installations
Even brightness for the long run

24	120	3	60.000 hrs	5	20 m
V DC	LED/m	SDCM	L70/B10	Years**	



Product Code	Reel Length	Color Temp.	Luminous Flux/m	Angle	CRI	t _c max.	t _s max.	Max. Op. Length	IP	EEL	RRP*
5924201	20 m	2.700 K	810 lm	120°	90	75 °C	40 °C	20 m	IP00		403,28 €
5924301	20 m	3.000 K	850 lm	120°	90	75 °C	40 °C	20 m	IP00		403,28 €

Insufficient cooling can damage the LED strip and shorten its service life significantly.
** Consumer warranty only. Warranty conditions on page 258.

Light Strips Slim

Flexible and inconspicuous.
Our Slim light strips fit into the tightest corners and narrow fixtures. They offer space-saving, inconspicuous lighting solutions with high light quality – ideal for elegant accents, furniture lighting, or indirect light.

50 010 0 010 010 010

CRI: 94,8



Color spectrum

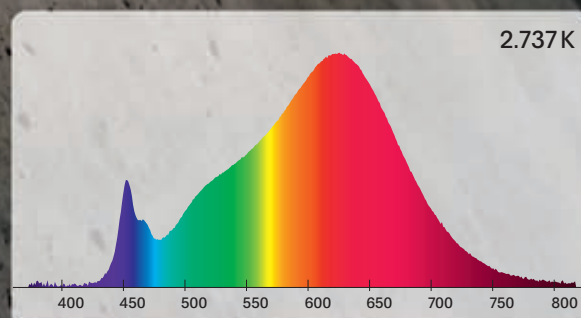

Tested product: Slim COB Freecut 5 W/m – 5944701
The measured data are average values and represent the product group as an example.

New. Light Strip Slim COB Freecut 5 W/m

Homogeneous illumination
Extremely slim design
For delicate installation and inconspicuous light lines

24	480	1	5	54.000 hrs	5
V DC	LED/m	BIN	SDCM	L70/B10	Years**



Product Code	Reel Length	Color Temp.	Luminous Flux/m	Angle	CRI	t _c max.	t _s max.	Max. Op. Length	IP	EEL	RRP*
5944701	5 m	2.700 K	330 lm	180°	90	60 °C	45 °C	5 m	IP00		60,08 €
5944801	5 m	3.000 K	340 lm	180°	90	60 °C	45 °C	5 m	IP00		60,08 €

Light Strip Slim COB 8 W/m

Homogeneous illumination
Extremely slim design
For delicate installation and inconspicuous light lines

24	480	3	50.000 hrs	5
V DC	LED/m	SDCM	L70/B10	Years**



Product Code	Reel Length	Color Temp.	Luminous Flux/m	Angle	CRI	t _c max.	t _s max.	Max. Op. Length	IP	EEL	RRP*
5930701	5 m	2.700 K	700 lm	140°	90	65 °C	45 °C	5 m	IP00		100,76 €
5930801	5 m	3.000 K	700 lm	140°	90	65 °C	45 °C	5 m	IP00		100,76 €

Light Strip Slim 12 W/m

Requires an aluminum profile
Extremely slim design
For delicate installation and inconspicuous light lines

24	266	1	5	50.000 hrs	5
V DC	LED/m	BIN	SDCM	L70/B10	Years**



Product Code	Reel Length	Color Temp.	Luminous Flux/m	Angle	CRI	t _c max.	t _s max.	Max. Op. Length	IP	EEL	RRP*
5939401	5 m	2.700 K	1.150 lm	120°	90	70 °C	45 °C	5 m	IP00		89,83 €
5939501	5 m	3.000 K	1.150 lm	120°	90	70 °C	45 °C	5 m	IP00		89,83 €

Insufficient cooling can damage the LED strip and shorten its service life significantly.
** Consumer warranty only. Warranty conditions on page 258.

Light Strips Dim-To-Warm

Warmth that glows with you.
Our Dim-To-Warm light strips not only adjust their brightness when dimmed, but also color temperature – from neutral white light to a warm, soft tone. Perfect for living areas, restaurants, and rooms with a cozy atmosphere.



Color spectrum

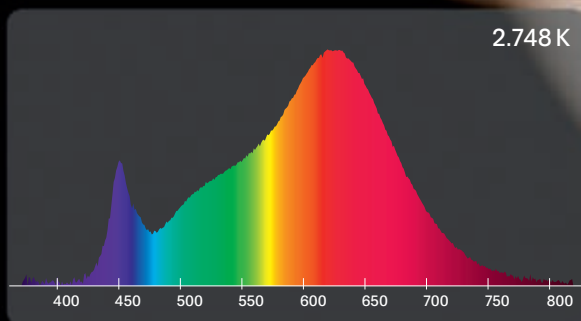

CRI: 94,8



Tested product: Dim-To-Warm 20 W/m – 5936501
The measured data are average values and represent the product group as an example.

Light Strip Dim-To-Warm COB 12 W/m

Requires an aluminum profile
Homogeneous illumination
Automatic reduction of color temperature when dimming

24	560	1	5	50.000 hrs	3
V DC	LED/m	BIN	SDCM	L70/B10	Years**

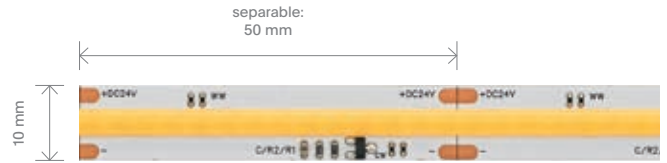

Product Code	Reel Length	Color Temp.	Luminous Flux/m	Angle	CRI	t _c max.	t _s max.	Max. Op. Length	IP	EEL	RRP*
5837501	5 m	2.700-2.200 K	960 lm	180°	90	65 °C	60 °C	5 m	IP00		79,75 €

Light Strip Dim-To-Warm 10 W/m

Requires an aluminum profile
Automatic reduction of color temperature when dimming
Warmer dimmed light creates a cozy, relaxed atmosphere

24	168	1	3	54.000 hrs	5
V DC	LED/m	BIN	SDCM	L70/B10	Years**



Product Code	Reel Length	Color Temp.	Luminous Flux/m	Angle	CRI	t _c max.	t _s max.	Max. Op. Length	IP	EEL	RRP*
5936201	5 m	3.000-1.800 K	1.104 lm	120°	90	85 °C	80 °C	5 m	IP00		109,16 €

New. Light Strip Dim-To-Warm 18 W/m

Requires an aluminum profile
Automatic reduction of color temperature when dimming
Warmer dimmed light creates a cozy, relaxed atmosphere

24	224	1	3	54.000 hrs	5
V DC	LED/m	BIN	SDCM	L70/B10	Years**



Product Code	Reel Length	Color Temp.	Luminous Flux/m	Angle	CRI	t _c max.	t _s max.	Max. Op. Length	IP	EEL	RRP*
5914501	5 m	3.000-1.800 K	1.480 lm	120°	90	65 °C	45 °C	5 m	IP00		130,17 €

Light Strip Dim-To-Warm 20 W/m

Requires an aluminum profile
Automatic reduction of color temperature when dimming
Warmer dimmed light creates a cozy, relaxed atmosphere

24	240	1	3	43.000 hrs	3
V DC	LED/m	BIN	SDCM	L70/B10	Years**

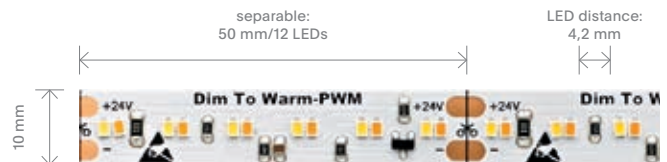

Product Code	Reel Length	Color Temp.	Luminous Flux/m	Angle	CRI	t _c max.	t _s max.	Max. Op. Length	IP	EEL	RRP*
5936501	5 m	3.000-1.800 K	1.900 lm	120°	90	60 °C	40 °C	5 m	IP00		151,18 €

Insufficient cooling can damage the LED strip and shorten its service life significantly.
** Consumer warranty only. Warranty conditions on page 258.

Light Strips Tunable White

Light tailored to your needs.
 With our Tunable White light strips, you can adjust color temperature continuously, from warm white to daylight white. Perfect for living areas, offices and all rooms that need natural light.

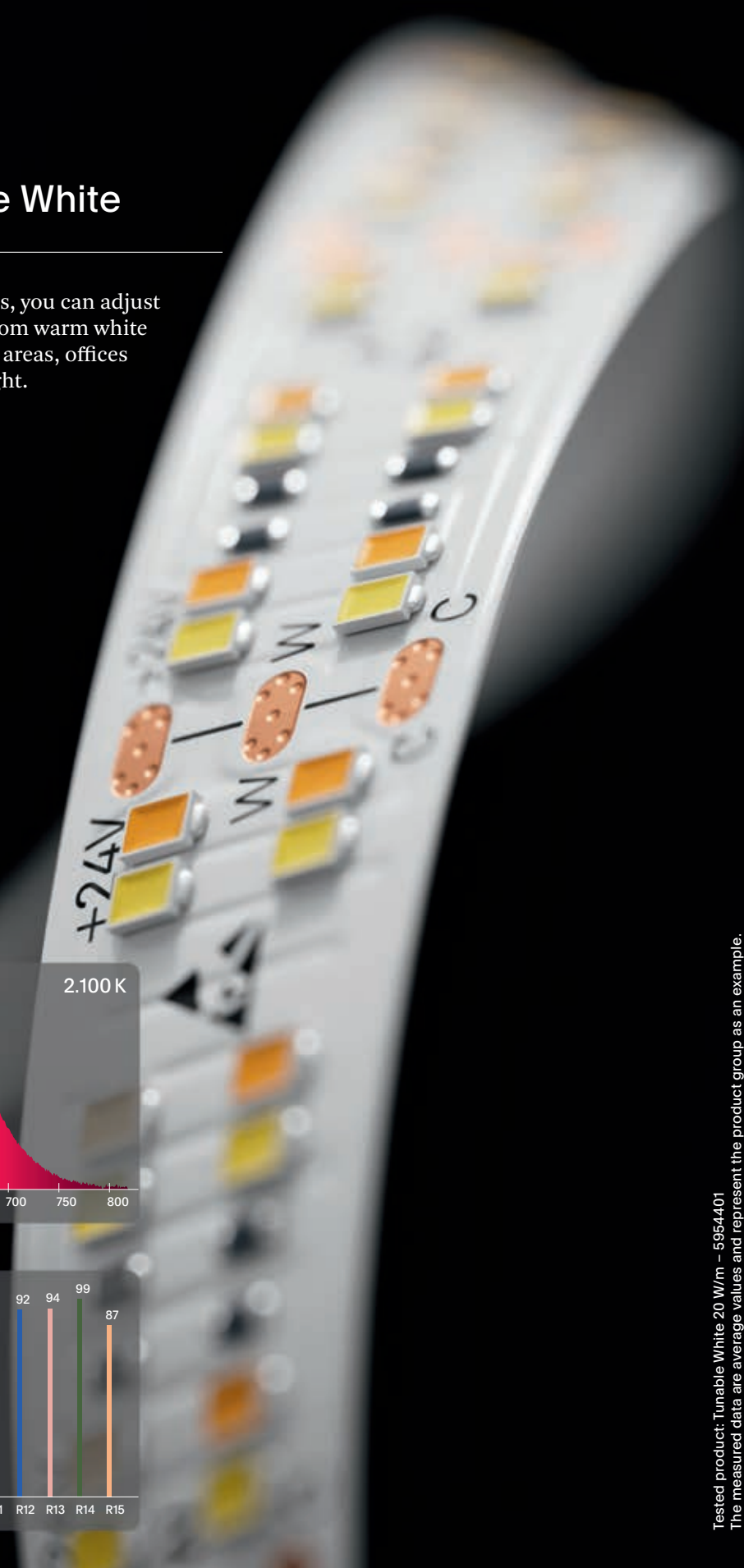

Color spectrum

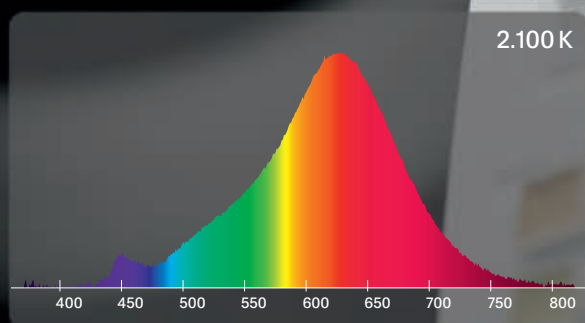

CRI: 92,3



Tested product: Tunable White 20 W/m - 5954401
 The measured data are average values and represent the product group as an example.

New. Light Strip Tunable White COB 15 W/m

Requires an aluminum profile
 Homogeneous illumination
 Fully tunable color temperature
 The right light for every time of the day and any mood
 Flexible use in offices, living rooms and hotels

24	640	1	5	50.000 hrs	5
V DC	LED/m	BIN	SDCM	L70/B10	Years**



Product Code	Reel Length	Color Temp.	Luminous Flux/m	Angle	CRI	t _c max.	t _a max.	Max. Op. Length	IP	EEL	RRP*
5914701	5 m $\frac{1}{cm}$	4.000–2.700 K	713+680 lm	180°	90	65 °C	45 °C	5 m	IP00		92,35 €

Light Strip Tunable White 20 W/m

Requires an aluminum profile
 Fully tunable color temperature
 The right light for every time of the day and any mood
 Flexible use in offices, living rooms and hotels

24	288	1	5	54.000 hrs	5
V DC	LED/m	BIN	SDCM	L70/B10	Years**

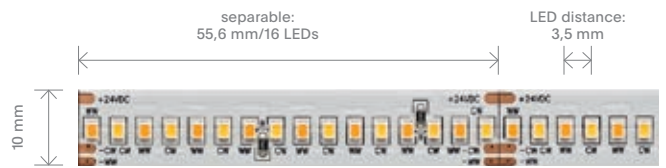

Product Code	Reel Length	Color Temp.	Luminous Flux/m	Angle	CRI	t _c max.	t _a max.	Max. Op. Length	IP	EEL	RRP*
5954301	5 m $\frac{1}{cm}$	5.000–2.700 K	1.374+1.238 lm	120°	90	85 °C	80 °C	5 m	IP00		109,16 €
5954401	5 m $\frac{1}{cm}$	4.000–2.100 K	1.423+1.067 lm	120°	90	85 °C	80 °C	5 m	IP00		109,16 €

Light Strip Tunable White Double 38,4 W/m

Requires an aluminum profile
 Fully tunable color temperature
 The right light for every time of the day and any mood
 Flexible use in offices, living rooms and hotels

24	480	3	1	43.000 hrs	3
V DC	LED/m	SDCM	BIN	L70/B10	Years**



Product Code	Reel Length	Color Temp.	Luminous Flux/m	Angle	CRI	t _c max.	t _a max.	Max. Op. Length	IP	EEL	RRP*
5937101	5 m $\frac{1}{cm}$	4.000–2.100 K	1.700+1.500 lm	120°	90	60 °C	40 °C	5 m	IP00		151,18 €

Insufficient cooling can damage the LED strip and shorten its service life significantly.
 ** Consumer warranty only. Warranty conditions on page 258.

Light Strips Color

Colors and Light for every mood.
Our light strips offer versatile lighting options:
pure colors with RGB, vivid colors and clear white
with RGB/W, or a full range of colors combined
with warm white light thanks to RGB/TW.
Perfect for dynamic accents and a cozy
atmosphere in any room.



RGB Light Strips

Perfect for customizable, colorful accent lighting
54.000 hour lifespan (L70/B10)
High LED density of up to 840 LEDs/m
Primary/secondary feed-in every 1 m
3M adhesive tape is included with all light strips

RGB/W Light Strips

Additional white LED chips (compared to RGB light strips)
Up to 54.000 hour lifespan (L70/B10)
High luminous flux of up to 1.853 lm/m
Primary/secondary feed-in every 1 m
3M adhesive tape is included with all light strips

RGB/TW Light Strips

Additional white and warm-white LED chips
(compared to RGB light strips)
Up to 54.000 hour lifespan (L70/B10)
High luminous flux of up to 2.282 lm/m
Primary/secondary feed-in every 1 m
3M adhesive tape is included with all light strips

Light Strip RGB COB 15 W/m

—
 Requires an aluminum profile
 Homogeneous illumination
 Smooth color mixing for balanced, atmospheric lighting scenes

24	840	54.000 hrs	3
V DC	LED/m	L70/B10	Years**

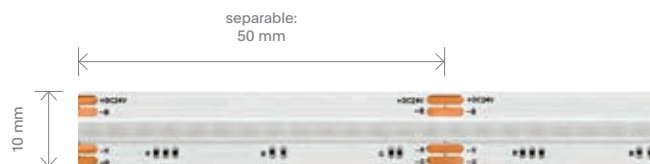

Product Code	Reel Length	Color Temp.	Luminous Flux/m	Angle	CRI	t _c max.	t _g max.	Max. Op. Length	IP	EEL	RRP*
5957601	5 m	RGB	544 lm	180°	—	65 °C	60 °C	5 m	IP00	—	99,92 €

Light Strip RGB 23 W/m

—
 Requires an aluminum profile
 All three colors in one chip
 High LED density for uniform color mixing and detailed light gradients

24	224	50.000 hrs	5
V DC	LED/m	L70/B10	Years**

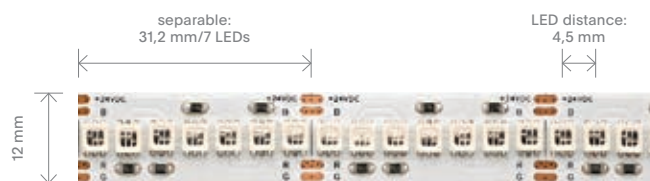

Product Code	Reel Length	Color Temp.	Luminous Flux/m	Angle	CRI	t _c max.	t _g max.	Max. Op. Length	IP	EEL	RRP*
5954801	5 m $\frac{1}{cm}$	RGB	1.025 lm	120°	—	80 °C	45 °C	5 m	IP00	—	159,58 €

Insufficient cooling can damage the LED strip and shorten its service life significantly.
 ** Consumer warranty only. Warranty conditions on page 258.

Light Strip RGB/W COB 16 W/m

Requires an aluminum profile
Homogeneous illumination
Colored light and white in one strip
Combines atmosphere and functionality

24	896	5	54.000 hrs	3
V DC	LED/m	SDCM	L70/B10	Years**

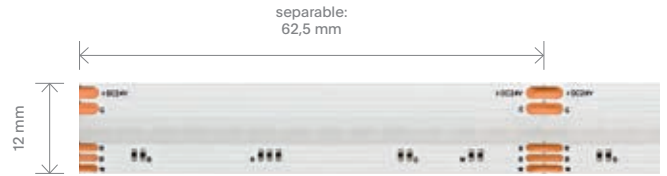

Product Code	Reel Length	Color Temp.	Luminous Flux/m	Angle	CRI	t _c max.	t _g max.	Max. Op. Length	IP	EEL	RRP*
5957501	5 m	RGB/2.700 K	640 lm	120°	90	70 °C	60 °C	5 m	IP00		109,16 €

New. Light Strip RGB/W COB 16 W/m

Requires an aluminum profile
Homogeneous illumination
Colored light and white in one strip
Combines atmosphere and functionality

24	840	1	5	30.000 hrs	3
V DC	LED/m	BIN	SDCM	L80/B10	Years**

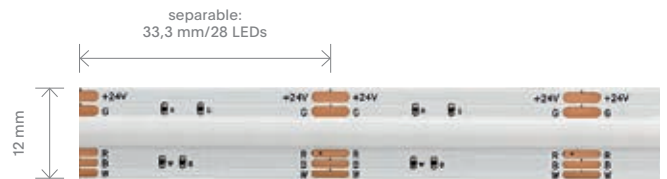

Product Code	Reel Length	Color Temp.	Luminous Flux/m	Angle	CRI	t _c max.	t _g max.	Max. Op. Length	IP	EEL	RRP*
5971501	5 m	RGB/2.700 K	846 lm	180°	90	80 °C	60 °C	5 m	IP00		121,76 €
5971601	5 m	RGB/3.000 K	894 lm	180°	90	80 °C	60 °C	5 m	IP00		121,76 €

Light Strip RGB/W 22 W/m

Requires an aluminum profile
All four colors in one chip
Colored light and white in one strip
Combines atmosphere and functionality

24	112	1	5	30.000 hrs	3
V DC	LED/m	BIN	SDCM	L70/B10	Years**



Product Code	Reel Length	Color Temp.	Luminous Flux/m	Angle	CRI	t _c max.	t _g max.	Max. Op. Length	IP	EEL	RRP*
5935601	5 m	RGB/2.700 K	1.609 lm	120°	90	85 °C	80 °C	5 m	IP00		180,59 €
5935701	5 m	RGB/3.000 K	1.657 lm	120°	90	85 °C	80 °C	5 m	IP00		180,59 €

Light Strip RGB+W 24 W/m

Requires an aluminum profile
Colored light and white in one strip
Combines atmosphere and functionality

24	192	1	3	30.000 hrs	3
V DC	LED/m	BIN	SDCM	L70/B10	Years**



Product Code	Reel Length	Color Temp.	Luminous Flux/m	Angle	CRI	t _c max.	t _g max.	Max. Op. Length	IP	EEL	RRP*
5980001	5 m	RGB/2.700 K	1.814 lm	120°	90	85 °C	80 °C	5 m	IP00		151,18 €
5937801	5 m	RGB/3.000 K	1.853 lm	120°	90	85 °C	80 °C	5 m	IP00		151,18 €

Insufficient cooling can damage the LED strip and shorten its service life significantly.
** Consumer warranty only. Warranty conditions on page 258.

Light Strip RGB/TW COB 16 W/m

Requires an aluminum profile
 Homogeneous illumination
 Combines color, cold and warm light in one strip

24	840	5	54.000 hrs	3
V DC	LED/m	SDCM	L70/B10	Years**

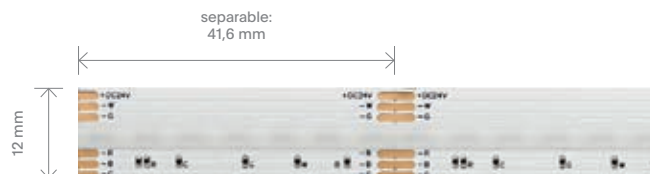

Product Code	Reel Length	Color Temp.	Luminous Flux/m	Angle	CRI	t _c max.	t _a max.	Max. Op. Length	IP	EEL	RRP*
5957701	5 m	RGB+6.500-2.700 K	925 lm	180°	90	65 °C	60 °C	5 m	IP00		109,16 €

Light Strip RGB+TW 20 W/m

Requires an aluminum profile
 Combines color, cold and warm light in one strip

24	210	1	30.000 hrs	3
V DC	LED/m	BIN	L70/B10	Years**



Product Code	Reel Length	Color Temp.	Luminous Flux/m	Angle	CRI	t _c max.	t _a max.	Max. Op. Length	IP	EEL	RRP*
5938201	5 m	RGB/6.500-2.300 K	1.662 lm	120°	80	85 °C	80 °C	5 m	IP00		121,76 €

Light Strip RGB/TW 32 W/m

Requires an aluminum profile
 All five colors in one chip
 Combines color, cold and warm light in one strip

24	112	1	30.000 hrs	3
V DC	LED/m	BIN	L70/B10	Years**



Product Code	Reel Length	Color Temp.	Luminous Flux/m	Angle	CRI	t _c max.	t _a max.	Max. Op. Length	IP	EEL	RRP*
5938301	5 m	RGB/6.500-2.300 K	2.282 lm	120°	80	85 °C	80 °C	3 m	IP00		260,42 €

Insufficient cooling can damage the LED strip and shorten its service life significantly.
 ** Consumer warranty only. Warranty conditions on page 258.

Light Strips High Temperature IP65 / IP67

Perfect wellness: Specially developed for high temperatures and humidity, our High Temperature light strips provide mood-enhancing, warm light for saunas and spas—also available in RGB/W versions.



Light Strip High Temperature COB IP67 10 W/m

Ideal for saunas, up to 105 °C
Does not include adhesive tape
Includes mounting clips

24	480	5	60.000 hrs	3	105
V DC	LED/m	SDCM	L70/B10	Years**	°C

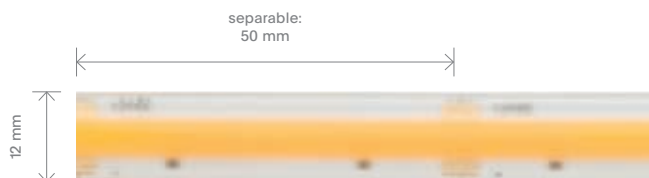

Product Code	Reel Length	Color Temp.	Luminous Flux/m	Angle	CRI	t _c max.	t _a max.	Max. Op. Length	IP	EEL	RRP*
5938901	5 m	2.700 K	840 lm	120°	90	120 °C	105 °C	5 m	IP67		142,77 €

New. Light Strip High Temperature RGB/W IP65 10 W/m

Ideal for saunas, up to 95 °C
Does not include adhesive tape
Includes mounting clips

24	60	54.000 hrs	2	95
V DC	LED/m	L70/B10	Years**	°C

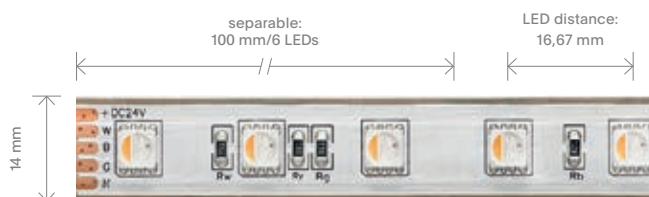

Product Code	Reel Length	Color Temp.	Luminous Flux/m	Angle	CRI	t _c max.	t _a max.	Max. Op. Length	IP	EEL	RRP*
5938501	5 m	RGB/2.700 K	722 lm	120°	80	115 °C	95 °C	5 m	IP65		151,18 €

Insufficient cooling can damage the LED strip and shorten its service life significantly.
** Consumer warranty only. Warranty conditions on page 258.

Light Strips IP67, Single Color

Can handle any weather. Our light strips for the outdoors are IP67-rated – perfectly suited for continuous use outside. On facades, patios, or in the garden... they provide uniform light and are highly resistant to moisture, dust, and weather conditions.



New. Light Strip IP67 COB Freecut 16 W/m

Requires an aluminum profile
 Water- and dustproof for outdoor use
 High light quality in a robust design
 Tried and tested in gardens, on patios, and on facades

24	546	1	5	54.000 hrs	3
V DC	LED/m	BIN	SDCM	L70/B10	Years**



Product Code	Reel Length	Color Temp.	Luminous Flux/m	Angle	CRI	t _c max.	t _a max.	Max. Op. Length	IP	EEL	RRP*
5915001	5 m	2.700 K	1.150 lm	180°	80	65 °C	45 °C	5 m	IP67		92,35 €
5915101	5 m	3.000 K	1.200 lm	180°	80	65 °C	45 °C	5 m	IP67		92,35 €
5915201	5 m	4.000 K	1.250 lm	180°	80	65 °C	45 °C	5 m	IP67		92,35 €
5915301	5 m	6.500 K	1.300 lm	180°	80	65 °C	45 °C	5 m	IP67		92,35 €

Light Strip IP67 Long Distance 9,6 W/m

Water- and dustproof for outdoor use
 Up to 20 m with single feed-in
 Tried and tested in gardens, on patios, and on facades

24	120	3	60.000 hrs	5	20 m
V DC	LED/m	SDCM	L70/B10	Years**	



Product Code	Reel Length	Color Temp.	Luminous Flux/m	Angle	CRI	t _c max.	t _a max.	Max. Op. Length	IP	EEL	RRP*
5924401	20 m	2.700 K	710 lm	120°	90	75 °C	40 °C	20 m	IP67		478,91 €
5924501	20 m	3.000 K	745 lm	120°	90	75 °C	40 °C	20 m	IP67		478,91 €

Insufficient cooling can damage the LED strip and shorten its service life significantly.
 ** Consumer warranty only. Warranty conditions on page 258.

Light Strips IP67, Multicolor

Colorful accents outdoors. Our multicolor light strips for the outdoors are IP67-rated – perfectly suited for mood-enhancing lighting effects outside. A combination of durable technology with a colorful cornucopia of light – even in wet and adverse weather conditions.



Light Strip IP67 Dim-To-Warm 10 W/m

Requires an aluminum profile
Automatic warming of color temperature with dimming

24	168	1	5	30.000 hrs	3
V DC	LED/m	BIN	SDCM	L70/B10	Years**

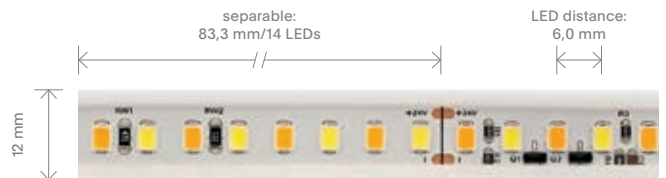

Product Code	Reel Length	Color Temp.	Luminous Flux/m	Angle	CRI	t _c max.	t _s max.	Max. Op. Length	IP	EEL	RRP*
5955201	5 m $\frac{1}{cm}$	4.000–2.200 K	1.016 lm	120°	90	85 °C	80 °C	5 m	IP67		151,18 €

Light Strip IP67 RGB 14,4 W/m

Requires an aluminum profile
For multicolor lighting in the outdoors
Suitable for facades, gardens and outdoor installations

24	120	50.000 hrs	3
V DC	LED/m	L70/B10	Years**

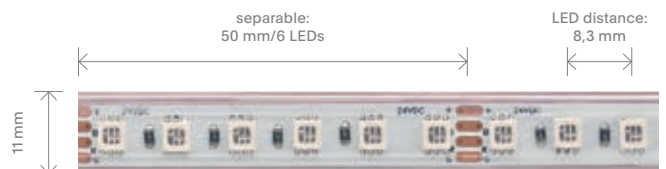

Product Code	Reel Length	Color Temp.	Luminous Flux/m	Angle	CRI	t _c max.	t _s max.	Max. Op. Length	IP	EEL	RRP*
5955401	5 m $\frac{1}{cm}$	RGB	480 lm	120°	—	75 °C	45 °C	5 m	IP67	—	130,17 €

Light Strip IP67 RGB+W 15 W/m

Requires an aluminum profile
For multicolor lighting in the outdoors
Suitable for facades, gardens and outdoor installations

24	192	1	3	30.000 hrs	3
V DC	LED/m	BIN	SDCM	L70/B10	Years**



Product Code	Reel Length	Color Temp.	Luminous Flux/m	Angle	CRI	t _c max.	t _s max.	Max. Op. Length	IP	EEL	RRP*
5939801	5 m $\frac{1}{cm}$	RGB/2.700 K	1.155 lm	120°	90	85 °C	80 °C	5 m	IP67		167,98 €

Insufficient cooling can damage the LED strip and shorten its service life significantly.
** Consumer warranty only. Warranty conditions on page 258.

Light Strips IP68, Single Color

IP68 strip lights for indoor and outdoor use
 Weather- and waterproof (up to 1 m)
 High color rendering, Ra 90
 Long-lasting silicone encapsulation

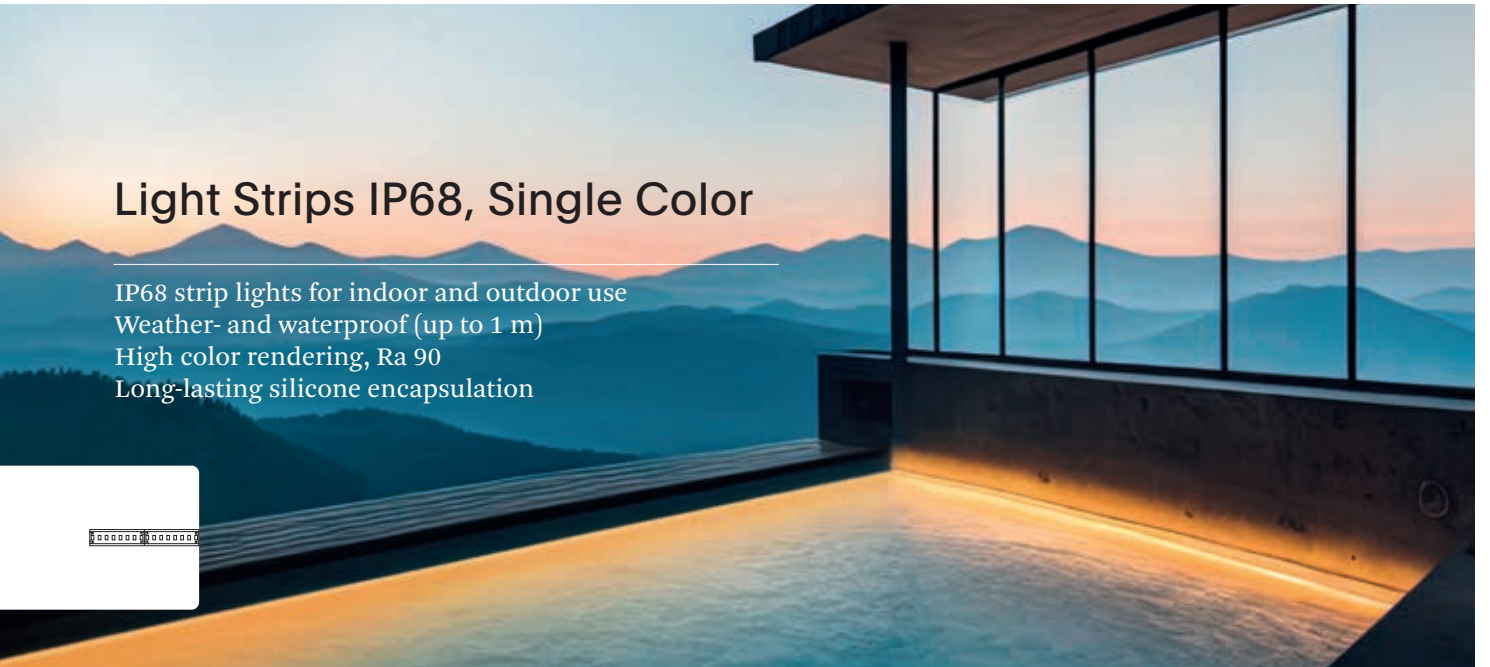
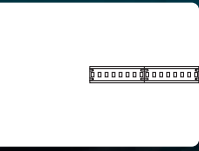

Light Strip IP68 9,6 W/m

Fully encapsulated for extreme conditions
 Ready-to-use for wellness areas, tech rooms and bathrooms

24	128	1	5	30.000 hrs	3
V DC	LED/m	BIN	SDCM	L70/B10	Years**



Product Code	Reel Length	Color Temp.	Luminous Flux/m	Angle	CRI	t _c max.	t _g max.	Max. Op. Length	IP	EEL	RRP*
5958501	5 m $\frac{1}{cm}$	2.700 K	1.248 lm	120°	90	80 °C	70 °C	5 m	IP68		99,92 €
5958601	5 m $\frac{1}{cm}$	3.000 K	1.296 lm	120°	90	80 °C	70 °C	5 m	IP68		99,92 €

Light Strip IP68 14,4 W/m

Requires an aluminum profile
 Fully encapsulated for extreme conditions

24	160	1	5	30.000 hrs	3
V DC	LED/m	BIN	SDCM	L70/B10	Years**



Product Code	Reel Length	Color Temp.	Luminous Flux/m	Angle	CRI	t _c max.	t _g max.	Max. Op. Length	IP	EEL	RRP*
5958701	5 m $\frac{1}{cm}$	2.700 K	1.872 lm	120°	90	80 °C	70 °C	5 m	IP68		120,08 €
5958801	5 m $\frac{1}{cm}$	3.000 K	1.944 lm	120°	90	80 °C	70 °C	5 m	IP68		120,08 €

Light Strip IP68 18 W/m

Requires an aluminum profile
 Fully encapsulated for extreme conditions

24	192	1	5	30.000 hrs	2
V DC	LED/m	BIN	SDCM	L70/B10	Years**

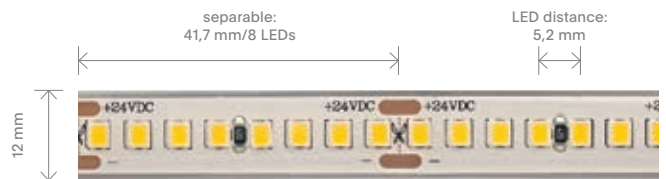

Product Code	Reel Length	Color Temp.	Luminous Flux/m	Angle	CRI	t _c max.	t _g max.	Max. Op. Length	IP	EEL	RRP*
5958901	5 m $\frac{1}{cm}$	2.700 K	2.250 lm	120°	90	85 °C	70 °C	5 m	IP68		139,92 €
5958001	5 m $\frac{1}{cm}$	3.000 K	2.340 lm	120°	90	85 °C	70 °C	5 m	IP68		139,92 €

Insufficient cooling can damage the LED strip and shorten its service life significantly.
 ** Consumer warranty only. Warranty conditions on page 258.

Light Strips Art

Gracious, precise and extraordinary: With their homogeneous, dot-free light line and matte silicone surface, these light strips set new standards. White, colored or three-directional – for stylish presentation indoors and outdoors.

Features

Homogenous light line without visible light dots in various color temperatures
Additional versions in RGB and RGB/W
Versions with different light emission: three-directional, upward, and sideways

Opalized, flexible strip light, encapsulated in silicone
IP67 rating for indoor and outdoor use
Resistant to UV radiation, solvents, and salt water
Impact protection up to IK10

Elegant, matte light emission area
Solder-free feed-in and wide choice of profiles

New.

Light Strips Art Omni

Three-directional illumination
 5 year guarantee**
 Primary/secondary feed-in every 0,5 m
 Please use suitable profiles: page 118

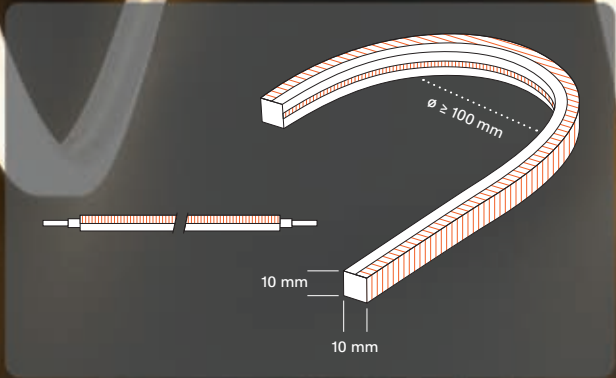

New. Light Strip Art Omni IP67 10 W/m

24	120	1	56.000 hrs	5
V DC	LED/m	BIN	L70/B10	Years**

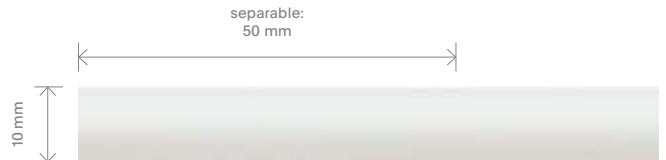

Product Code	Reel Length	Color Temp.	Luminous Flux/m	Angle	CRI	t _c max.	t _s max.	Max. Op. Length	IP	EEL	RRP*
5919001	5 m	2.700 K	740 lm	180°	90	60 °C	45 °C	5 m	IP67		130,17 €
5919101	5 m	3.000 K	790 lm	180°	90	60 °C	45 °C	5 m	IP67		130,17 €
5919201	5 m	4.000 K	830 lm	180°	90	60 °C	45 °C	5 m	IP67		130,17 €

Light Strip Art Omni – Accessories

End cap and mounting equipment

Product Code	Feed-in	IP	RRP*
1 9838001 New	Silicone end cap	IP65	3,28 €
2 9875101	Silicone adhesive for end cap (10 ml)	IP65	5,46 €



Product Code	Mounting equipment	RRP*
3 9838101 New	Stainless steel clips (package contains 10 pcs.)	5,46 €



** Consumer warranty only. Warranty conditions on page 258.

New.

Light Strips Art 3D

One-directional illumination
Can be bent horizontally and vertically
5 year guarantee**
Primary/secondary feed-in every 0,5 m
Please use suitable profiles:
page 119

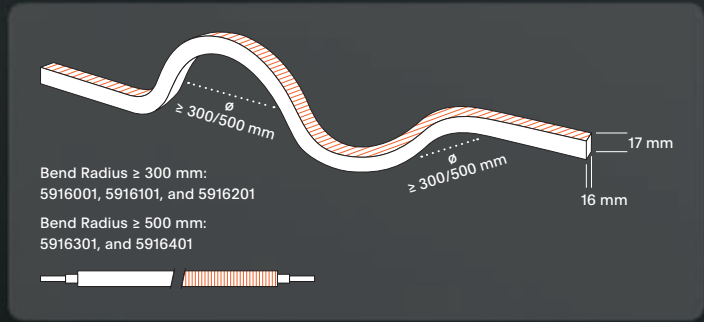

New. Light Strip Art 3D IP67 10 W/m

24	120	1	3	56.000 hrs	5
V DC	LED/m	BIN	SDCM	L70/B10	Years**

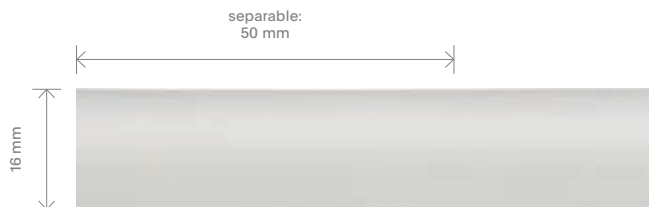

Product Code	Reel Length	Color Temp.	Luminous Flux/m	Angle	CRI	t _c max.	t _g max.	Max. Op. Length	IP	EEL	RRP*
5916001	5 m	2.700 K	666 lm	120°	90	65 °C	45 °C	5 m	IP67		159,58 €
5916101	5 m	3.000 K	675 lm	120°	90	65 °C	45 °C	5 m	IP67		159,58 €
5916201	5 m	4.000 K	710 lm	120°	90	65 °C	45 °C	5 m	IP67		159,58 €

New. Light Strip Art 3D IP67 RGB 10 W/m

24	96	54.000 hrs	5
V DC	LED/m	L70/B10	Years**

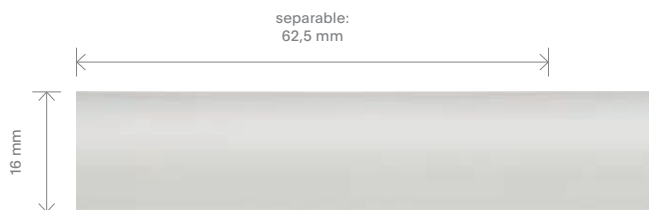

Product Code	Reel Length	Color Temp.	Luminous Flux/m	Angle	CRI	t _c max.	t _g max.	Max. Op. Length	IP	EEL	RRP*
5916301	5 m	RGB	250 lm	120°	—	65 °C	45 °C	5 m	IP67	—	193,19 €

New. Light Strip Art 3D IP67 RGB/W 15 W/m

24	96	1	54.000 hrs	5
V DC	LED/m	BIN	L70/B10	Years**

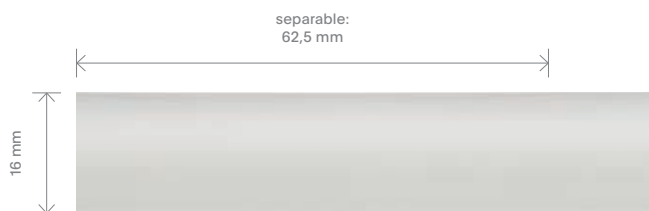

Product Code	Reel Length	Color Temp.	Luminous Flux/m	Angle	CRI	t _c max.	t _g max.	Max. Op. Length	IP	EEL	RRP*
5916401	5 m	RGB/2.700 K	430 lm	120°	90	65 °C	45 °C	5 m	IP67		201,60 €

Light Strip Art 3D – Accessories
End cap and mounting equipment

Product Code	Feed-in	IP	RRP*
1 9838201 New	Silicone end cap	IP65	3,28 €
2 9875101	Silicone adhesive for end cap (10 ml)	IP65	5,46 €



Product Code	Mounting equipment	RRP*
3 9838801 New	Aluminum clips (package contains 10 pcs.)	5,80 €



** Consumer warranty only. Warranty conditions on page 258.

New.

Light Strips Art Top

One-directional upwards illumination
 Can be bent vertically
 5 year guarantee**
 Primary/secondary feed-in every 0,5 m
 Please use suitable profiles: page 119

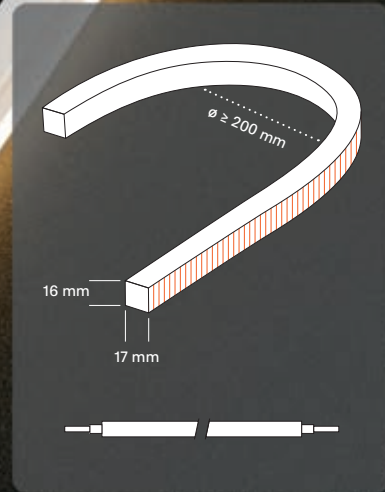

New. Light Strip Art Top IP67 10 W/m

24	120	3	56.000 hrs	5
V DC	LED/m	SDCM	L70/B10	Years**

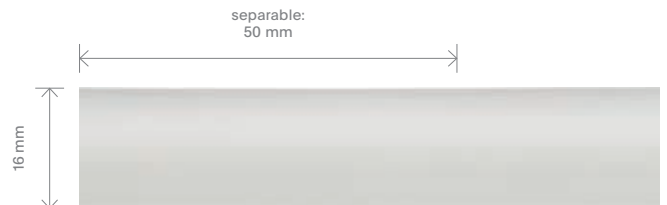

Product Code	Reel Length	Color Temp.	Luminous Flux/m	Angle	CRI	t _c max.	t _s max.	Max. Op. Length	IP	EEL	RRP*
5917001	7 m $\frac{1}{cm}$	2.700 K	775 lm	120°	90	65 °C	45 °C	7 m	IP67		210,00 €
5917101	7 m $\frac{1}{cm}$	3.000 K	800 lm	120°	90	65 °C	45 °C	7 m	IP67		210,00 €
5917201	7 m $\frac{1}{cm}$	4.000 K	825 lm	120°	90	65 °C	45 °C	7 m	IP67		210,00 €

New. Light Strip Art Top IP67 RGB 10 W/m

24	84	54.000 hrs	5
V DC	LED/m	L70/B10	Years**



Product Code	Reel Length	Color Temp.	Luminous Flux/m	Angle	CRI	t _c max.	t _s max.	Max. Op. Length	IP	EEL	RRP*
5917301	5 m $\frac{1}{cm}$	RGB	380 lm	120°	—	65 °C	45 °C	5 m	IP67	—	184,79 €

** Consumer warranty only. Warranty conditions on page 258.

New. Light Strip Art Top IP67 RGB/W 15 W/m

24 V DC	168 LED/m	1 BIN	54.000 hrs L70/B10	5 Years**
-------------------	---------------------	-----------------	------------------------------	---------------------



Product Code	Reel Length	Color Temp.	Luminous Flux/m	Angle	CRI	t _c max.	t _g max.	Max. Op. Length	IP	EEL	RRP*
5917401	5 m	RGB/2.700 K	760 lm	120°	90	65 °C	45 °C	5 m	IP67		193,19 €

New. Light Strip Art Top – Accessories

Feed-in, end cap, and mounting equipment

Product Code	Feed-in	IP	RRP*
1 9838401	Quick connector, single color	IP65	5,46 €
2 9838501	Quick connector, RGB	IP65	5,80 €
3 9838901	Quick end cap	IP65	3,28 €
4 9838201	Silicone end cap	IP65	3,28 €
5 9875101	Silicone adhesive for end cap (10 ml)	IP65	5,46 €



Product Code	Mounting equipment	RRP*
6 9838801 New	Aluminum clips (package contains 10 pcs.)	5,80 €

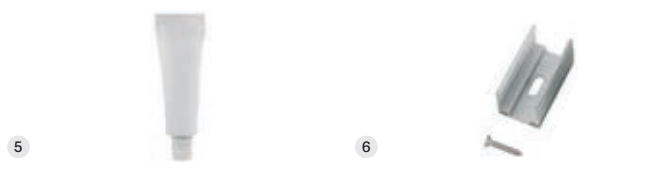

** Consumer warranty only. Warranty conditions on page 258.

New.

Light Strips Art Side

One-directional sideways illumination
 Can be bent horizontally
 5 year guarantee**
 Primary/secondary feed-in every 0,5 m
 Please use suitable profiles: page 119

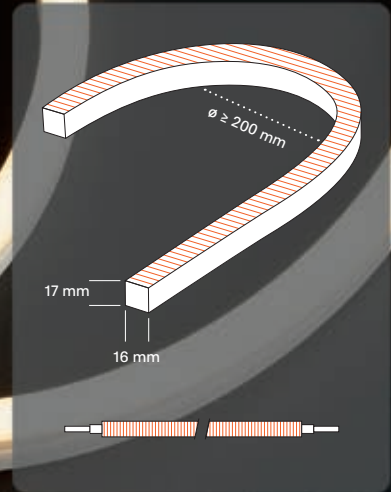

New. Light Strip Art Side IP67 10 W/m

24	120	3	56.000 hrs	5
V DC	LED/m	SDCM	L70/B10	Years**



Product Code	Reel Length	Color Temp.	Luminous Flux/m	Angle	CRI	t _c max.	t _s max.	Max. Op. Length	IP	EEL	RRP*
5918001	7 m $\frac{1}{cm}$	2.700 K	645 lm	120°	90	65 °C	45 °C	7 m	IP67		210,00 €
5918101	7 m $\frac{1}{cm}$	3.000 K	675 lm	120°	90	65 °C	45 °C	7 m	IP67		210,00 €
5918201	7 m $\frac{1}{cm}$	4.000 K	725 lm	120°	90	65 °C	45 °C	7 m	IP67		210,00 €

New. Light Strip Art Side IP67 RGB 10 W/m

24	84	54.000 hrs	5
V DC	LED/m	L70/B10	Years**



Product Code	Reel Length	Color Temp.	Luminous Flux/m	Angle	CRI	t _c max.	t _s max.	Max. Op. Length	IP	EEL	RRP*
5918301	5 m $\frac{1}{cm}$	RGB	330 lm	120°	—	65 °C	45 °C	5 m	IP67	—	184,79 €

** Consumer warranty only. Warranty conditions on page 258.

New. Light Strip Art Side IP67 RGB/W 15 W/m

24 V DC	168 LED/m	1 BIN	54.000 hrs L70/B10	5 Years**
-------------------	---------------------	-----------------	------------------------------	---------------------



Product Code	Reel Length	Color Temp.	Luminous Flux/m	Angle	CRI	t _c max.	t _g max.	Max. Op. Length	IP	EEL	RRP*
5918401	5 m	RGB/2.700 K	630 lm	120°	90	65 °C	45 °C	5 m	IP67		193,19 €

New. Light Strip Art Side – Accessories

Feed-in, end cap, and mounting equipment

Product Code	Feed-in	IP	RRP*
1 9838601	Quick connector, single color	IP65	5,46 €
2 9838701	Quick connector, RGB	IP65	5,80 €
3 9838901	Quick end cap	IP65	3,28 €
4 9838201	Silicone end cap	IP65	3,28 €
5 9875101	Silicone adhesive for end cap (10 ml)	IP65	5,46 €



Product Code	Mounting equipment	RRP*
6 9838801 New	Aluminum clips (package contains 10 pcs.)	5,80 €

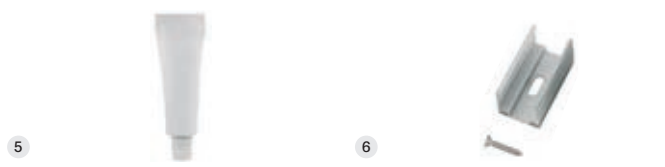

** Consumer warranty only. Warranty conditions on page 258.

Luxi Link Light Track

The flexible light track system for your kitchen. Luxi Link is the perfect solution for modern kitchen lighting: modular, versatile and easy to install. The system adapts to all your needs and provides functional light with style.







Luxi Link Light Track

Modular light track system for versatile use
 Tool-free installation using quick connectors
 Large selection of connectors, feed-ins and mounting equipment

Dimmable 	IP20	3 Years**
---	------	--------------



Product Code	Dimensions (L x W x H)	Wattage	Voltage	Color Temp.	Luminous Flux	CRI	Angle	Lifespan	EEL	RRP*
4010201	150 x 18 x 8 mm	3 W	24 V DC	3.000 K	200 lm	80	100°	40.000 hrs		11,34 €
4010401	300 x 18 x 8 mm	5 W	24 V DC	3.000 K	410 lm	80	100°	40.000 hrs		13,87 €
4010601	600 x 18 x 8 mm	9 W	24 V DC	3.000 K	650 lm	80	100°	40.000 hrs		29,33 €
4010801	1.000 x 18 x 8 mm	15 W	24 V DC	3.000 K	1.070 lm	80	100°	40.000 hrs		47,48 €

** Consumer warranty only. Warranty conditions on page 258.

Switches and Cables

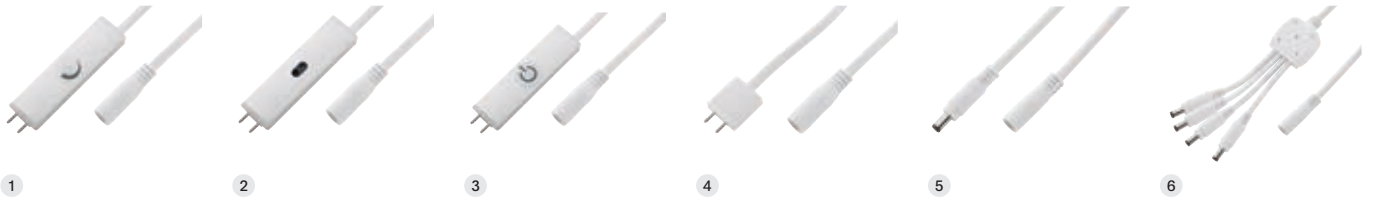

	Product Code	Switches and Cables	Length	Use	RRP*
1	4013401	Touch dimmer	500 mm	Smooth touch dimming	16,72 €
2	4013201	Sensor on/off switch	500 mm	Switching on/off using gestures	13,87 €
3	4013001	Touch on/off switch	500 mm	Switching on/off using touch	11,68 €
4	4012801	Cable	500 mm	Direct power supply for fixed installations without switch	5,80 €
5	4013801	Extension cable, 1 m	1.000 mm	Extension cord between light track and transformer	10,00 €
5	4013901	Extension cable, 2 m	2.000 mm	Extension cord between light track and transformer	13,87 €
6	4014001	4-way cable whip	500 mm	Parallel connection for up to four light tracks	11,68 €

Connectors

	Product Code	Connectors	RRP*
1	4011801	Direct Connector	2,10 €
2	4013601	Track connection cables, 50 cm	7,98 €
2	4013701	Track connection cables, 100 cm	10,00 €
3	4014201	Corner connector, left	5,80 €
3	4014401	Corner connector, right	5,80 €
4	4014601	T-Connector	5,80 €
5	4014801	Cross connector	5,80 €
6	4015001	90 ° connector for installation on furniture	5,80 €

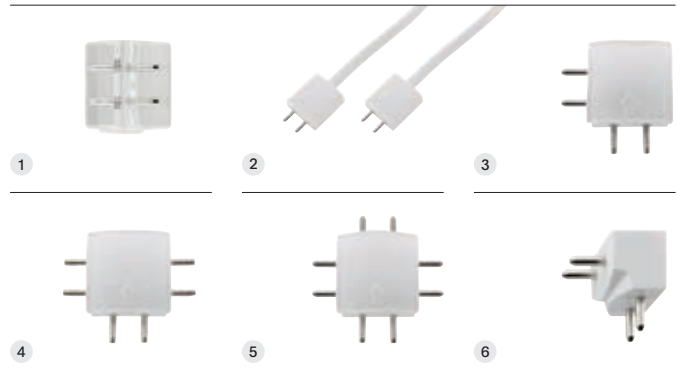

Mounting equipment

	Product Code	Mounting equipment (set: 2 pcs.)	RRP*
1	4011601	Mounting clip with screws	2,10 €
2	4012201	Mounting clip, 45 °, with screws	2,10 €
3	4012601	Magnet panels with adhesive pads	10,00 €



Drivers

Product Code	Style	Max. track length	Transformer cable	Track cable	Wattage	Voltage	Dimensions	RRP*
4011001	with connection cable	1.150 mm	1.800 mm	1.500 mm	20 W	24 V DC	50 x 90 x 30 mm	27,31 €
4011201	with connection cable	2.300 mm	1.800 mm	1.500 mm	36 W	24 V DC	50 x 100 x 30 mm	39,92 €
4011401	with connection cable	4.000 mm	1.800 mm	1.500 mm	60 W	24 V DC	50 x 110 x 30 mm	47,82 €

Light Strips High Voltage

Connect directly to the power supply, without ballast. Our 230 V light strips can be connected directly to the power supply – without transformer or special power supply. Installation with minimum effort and operation lengths of up to 50 m make them ideal for long light lines.

0 810000 0 0 0 010 0

Light Strip High Voltage IP65 14 W/m

Flicker-free
For indoor and outdoor use
UV-resistant

230 V AC	84 LED/m	5 SDCM	50.000 hrs L70/B10	5 Years**
--------------------	--------------------	------------------	------------------------------	---------------------



Product Code	Reel Length	Color Temp.	Luminous Flux/m	Angle	CRI	t _c max.	t _g max.	Max. Op. Length	IP	EEL	RRP*
25 m Reel											
5967201	25 m	2.700 K	1.100 lm	100°	90	85 °C	40 °C	50 m	IP65		899,08 €
5967301	25 m	3.000 K	1.200 lm	100°	90	85 °C	40 °C	50 m	IP65		899,08 €
5967401	25 m	4.000 K	1.300 lm	100°	90	85 °C	40 °C	50 m	IP65		899,08 €

Feed-in and End cap

Product Code	Feed-in	RRP*
1 5952101	Feed-in, wire 0,6 m	18,07 €
2 5952201	Feed-in, plug, 0,6 m	20,08 €
3 5952301	Connection cable, 0,6 m	18,07 €
4 5952001	End cap	3,28 €

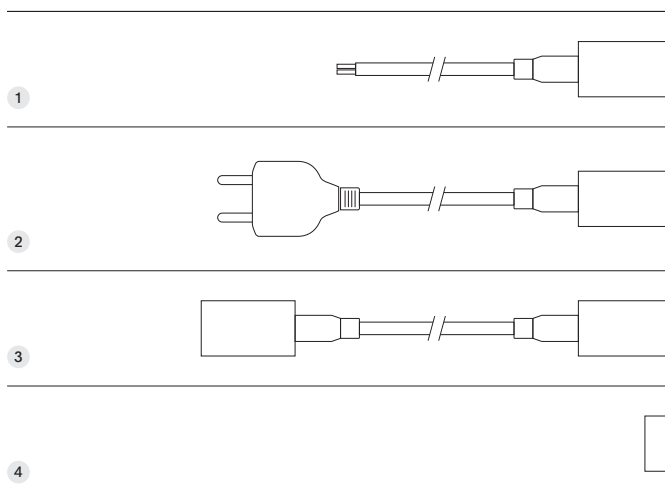

Mounting equipment

Product Code	Mounting equipment	RRP*
1 5952401	Mounting clips (package contains 20 pcs.)	10,00 €
2 9827601	HV surface mounted profile 19 1 m	7,98 €
2 9827701	HV surface mounted profile 19 2 m	15,88 €
3 9871601	3M adhesive tape 33 m x 12 mm	33,53 €

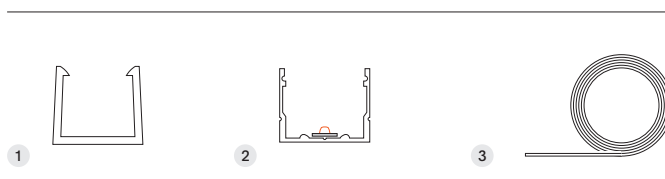

Insufficient cooling can damage the LED strip and shorten its service life significantly.
** Consumer warranty only. Warranty conditions on page 258.

Light Strip High Voltage IP65 8 W/m

For outdoor use

UV-resistant

230	144	5	50.000 hrs	5
V AC	LED/m	SDCM	L70/B10	Years**



Product Code	Reel Length	Color Temp.	Luminous Flux/m	Angle	CRI	t _c max.	t _s max.	Max. Op. Length	IP	EEL	RRP*
25 m Reel											
5968201	25 m	2.700 K	520 lm	120°	90	85 °C	42 °C	50 m	IP65		499,92 €
5968401	25 m	3.000 K	520 lm	120°	90	85 °C	42 °C	50 m	IP65		499,92 €
5968601	25 m	4.000 K	560 lm	120°	90	85 °C	42 °C	50 m	IP65		499,92 €
50 m reel											
5968301	50 m	2.700 K	520 lm	120°	90	85 °C	42 °C	50 m	IP65		999,92 €
5968501	50 m	3.000 K	520 lm	120°	90	85 °C	42 °C	50 m	IP65		999,92 €
5968701	50 m	4.000 K	560 lm	120°	90	85 °C	42 °C	50 m	IP65		999,92 €

Feed-in

Product Code	Feed-in	RRP*
1 5985101	Feed-in, wire 1,5 m	16,72 €
2 5985901	Feed-in, plug, 1,5 m	20,08 €
3 5985801	Connection cable, 0,6 m	16,72 €

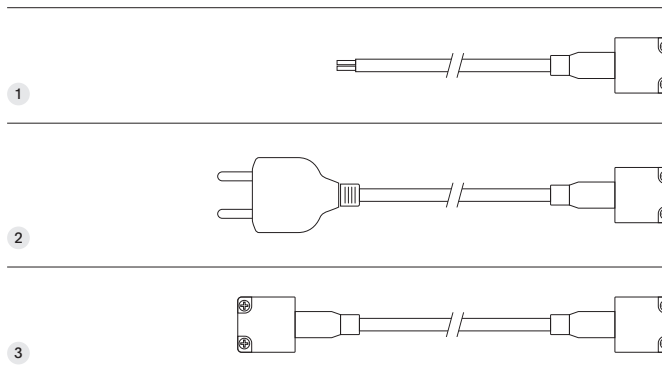

Connectors

Product Code	Connectors	RRP*
1 5984801	End cap	3,28 €
2 5985201	L-Connector	16,72 €
3 5985701	Direct Connector	12,18 €

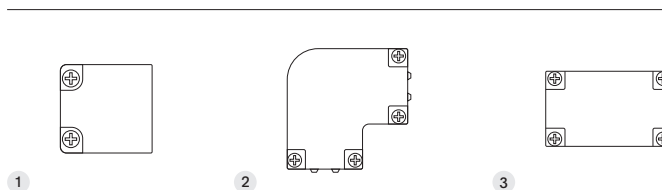

Mounting equipment

Product Code	Mounting equipment	RRP*
1 5985001	Mounting clips (package contains 20 pcs.)	10,00 €
2 9828701	HV surface mounted profile 15 1 m	7,98 €
2 9828801	HV surface mounted profile 15 2 m	15,88 €
3 9871601	3M adhesive tape 33 m x 12 mm	33,53 €

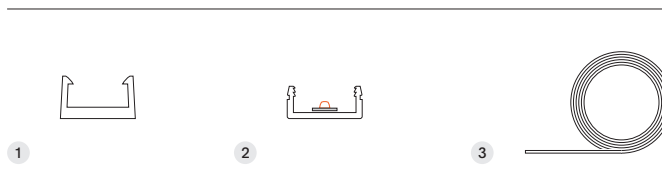

Insufficient cooling can damage the LED strip and shorten its service life significantly.

** Consumer warranty only. Warranty conditions on page 258.

Light Strip High Voltage 10 m set, plug-ready

The set consists of ready-mounted lights strips, a 1,5 m feed-in, and an end cap. Included replacement end caps make it possible to shorten the strip solder-free.



Light Strips

Light Strip High Voltage Set IP65 8 W/m

For outdoor use
UV-resistant

230	144	5	50.000 hrs	5
V AC	LED/m	SDCM	L70/B10	Years**



Product Code	Reel Length	Color Temp.	Luminous Flux/m	Angle	CRI	t _c max.	t _g max.	Max. Op. Length	IP	EEL	RRP*
10 m set, plug-ready											
5966301	10 m	2.700 K	520 lm	120°	90	85 °C	42 °C	50 m	IP65		220,08 €
5966401	10 m	3.000 K	520 lm	120°	90	85 °C	42 °C	50 m	IP65		220,08 €

Light Strip High Voltage Set0 IP65 14 W/m

For indoor and outdoor use
UV-resistant

230	84	5	50.000 hrs	5
V AC	LED/m	SDCM	L70/B10	Years**



Product Code	Reel Length	Color Temp.	Luminous Flux/m	Angle	CRI	t _c max.	t _g max.	Max. Op. Length	IP	EEL	RRP*
10 m set, plug-ready											
5966501	10 m	2.700 K	1.100 lm	100°	90	85 °C	40 °C	50 m	IP65		380,25 €
5966601	10 m	3.000 K	1.200 lm	100°	90	85 °C	40 °C	50 m	IP65		380,25 €

3M Adhesive Tape For Light Strips



Product Code	Reel Length	Reel Width	RRP*
3M adhesive tape 9448A Double-sided adhesive tape with good adhesive properties			
9871001	50 m	8 mm	10,00 €
9871101	50 m	10 mm	13,03 €
9871201	50 m	12 mm	15,04 €

Product Code	Reel Length	Reel Width	RRP*
3M adhesive tape VHB Sticks well to difficult surfaces			
9871501	33 m	10 mm	29,83 €
9871601	33 m	12 mm	33,53 €

Product Code	Reel Length	Reel Width	RRP*
3M adhesive tape 1600T Polyethylene foam adhesive tape with very good adhesive properties			
9871901	20 m	10 mm	12,18 €
9872001	20 m	12 mm	13,87 €

Insufficient cooling can damage the LED strip and shorten its service life significantly.
** Consumer warranty only. Warranty conditions on page 258.

Customization

We can customize light strips, profiles and devices according to your needs. Each individual case of lighting installation has its own specific requirements in terms of materials and workmanship. We will be happy to work with you on finding the right solution.



Customize Profiles

Cutting profiles to length, including aluminum or plastic covers, straight or mitered

Tape installation of light strips

Quality Control

Compatibility checks of the ordered components

Visual check of all components

Functionality test of all components

Customize Light Strips

Cutting light strips of all IP ratings to length

Cutting two- to six-core supply cables to length for various applications (e.g., without protection, with UV protection, or with ground cable, depending on requirements)

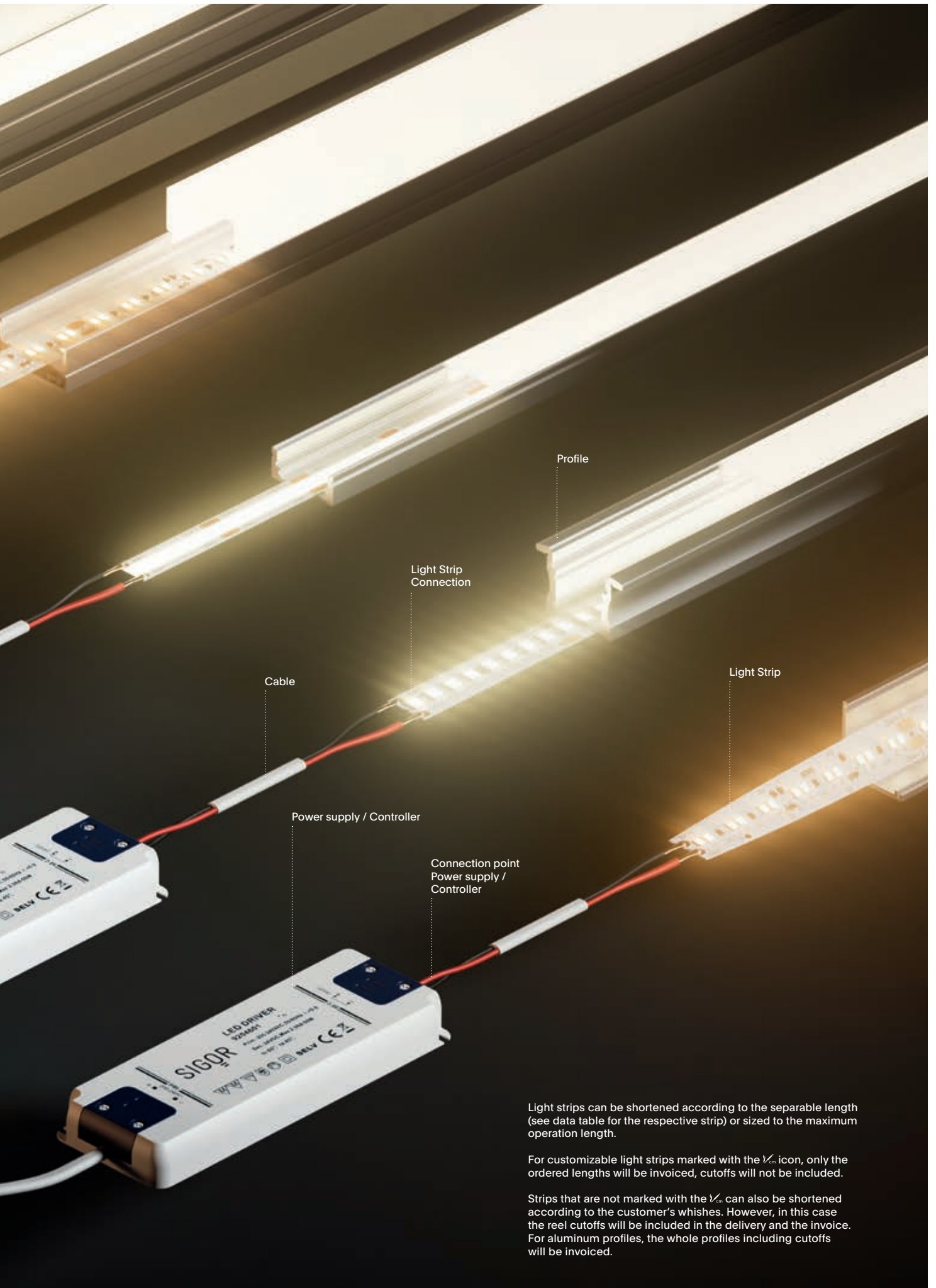

Light strips can be shortened according to the separable length (see data table for the respective strip) or sized to the maximum operation length.

For customizable light strips marked with the $\frac{1}{2}$ icon, only the ordered lengths will be invoiced, cutoffs will not be included.

Strips that are not marked with the $\frac{1}{2}$ icon can also be shortened according to the customer's wishes. However, in this case the reel cutoffs will be included in the delivery and the invoice. For aluminum profiles, the whole profiles including cutoffs will be invoiced.

Wall Profiles

—
For orientation and
path illumination
→ p. 114

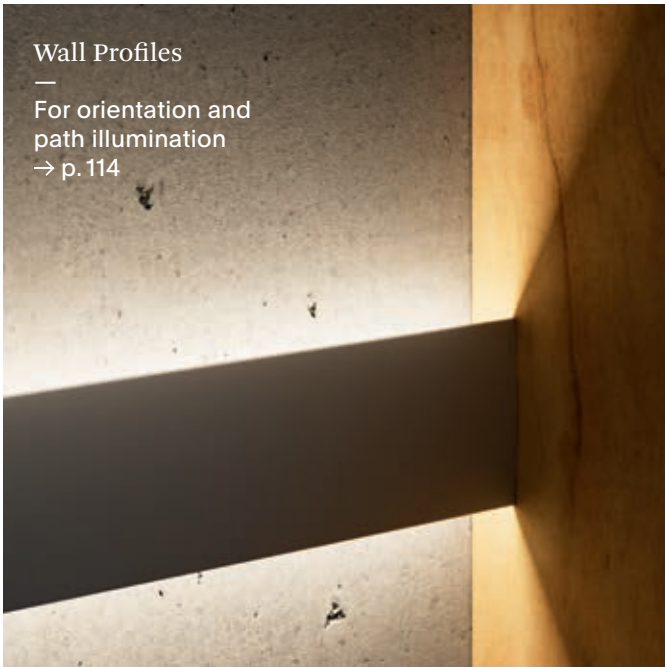

Surface Mounted Profiles

—
Standard cooling profiles
for haunches
→ p. 104

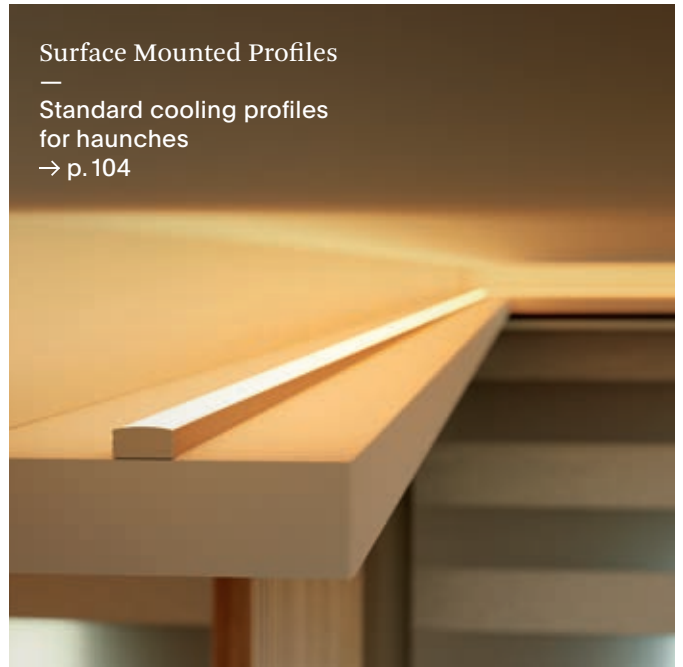

Build-In Profiles

—
For flush-mounted lighting
solutions on walls and ceilings
→ p. 112

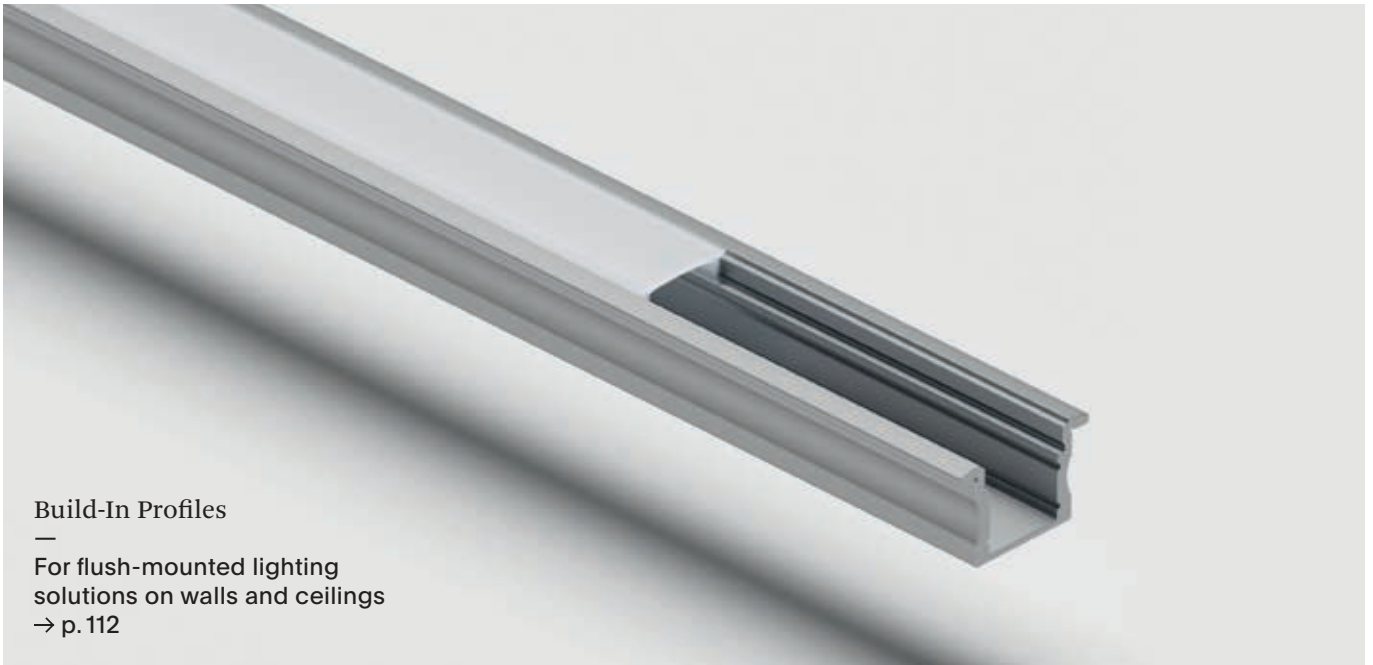

Corner Profiles

—
For base cabinet and
furniture lighting
→ p. 110



Profiles

Build-in and surface mounted profiles In various lengths From covers to mounting sets

The right accessories often make all the difference: High-quality aluminum cools down light strips and makes sure they run at optimum temperature. But our profiles can do so much more: If you cannot easily implement indirect lighting in a building, they help to set the right lighting accents.

Surface Mounted Profiles

Surface Mounted Profile Narrow 5 p. 105

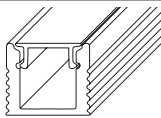

Surface Mounted Profile Multi spot 12 p. 105

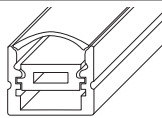

Surface Mounted Profile 12 p. 106

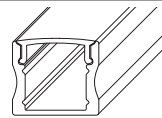

Surface Mounted Profile Flat 12 p. 106

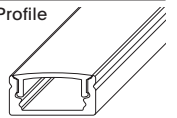

Surface Mounted Profile 13 p. 107

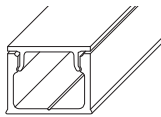

Surface Mounted Profile Mounting Rail 15 p. 107

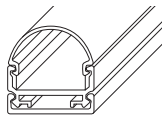

Surface Mounted Profile High Voltage 15 p. 108

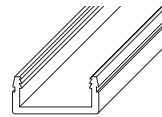

Surface Mounted Profile High Voltage 19 p. 108

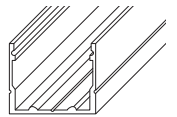

Surface Mounted Profile 15 p. 109

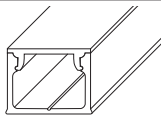

Surface Mounted Profile 20 p. 109

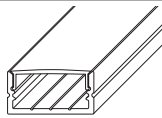

Corner Profiles

Corner Profile 10 p. 111

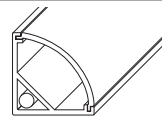

Corner Profile 20 p. 111

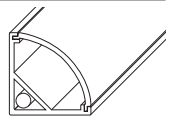

Build-In Profiles

Build-in Profile 12 p. 113

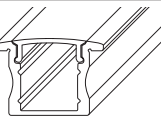

Build-In Profile Flat 12 p. 113

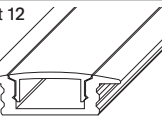

Wall Profiles

Wall Profile Up and Down 12 p. 114

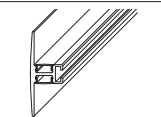

Wall Profile Up or Down 12 p. 115

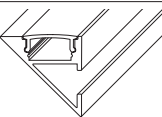

Wall Profile Up and Down 27 Driver p. 115

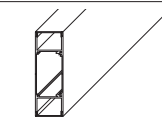

Recessed Profiles

Recessed Profile 10 Incl. Frosted Cover p. 117

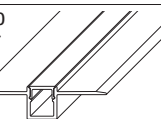

Recessed Profile 20 Incl. Frosted Cover p. 117

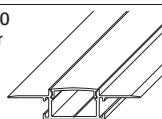

Light Strips Art Profile

Light Strips Art Omni Profile p. 118

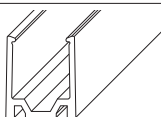

Light Strips Art Profile 1617 3D, Top, Side p. 119

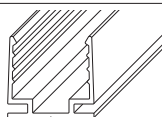

Light Strips Art Profile 1617 Cable duct 3D, Top, Side p. 119

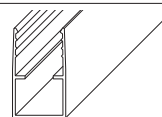

Light Strips Art Profile 1617 Bendable 3D, Top, Side p. 119

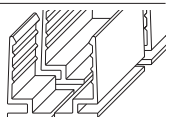

Surface Mounted Profiles

Versatile aluminum profiles with
clear, frosted, or opal covers
Easy to mount thanks to mounting clips
Passive cooling for light strips
In 1 m and 2 m lengths

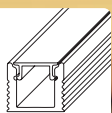

Surface Mounted Profile Flat 12
Product code: 9820601
page 106

Surface Mounted Profile Narrow 5
 For wall and ceiling installation
 Suitable for light strips up to 5 mm width

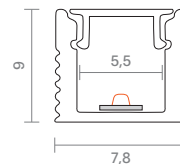

Product Code	Length	Max. Strip Width	Outer dimensions (W x H)	RRP*
--------------	--------	------------------	--------------------------	------

Surface Mounted Profile

9829401	1 m	5 mm	7,8 x 9 mm	5,46 €
9829501	2 m	5 mm	7,8 x 9 mm	10,00 €

Product Code	Length	Style	Material	RRP*
--------------	--------	-------	----------	------

Profile cover, frosted

9865701	1 m	flush	frosted	3,28 €
9865801	2 m	flush	frosted	5,80 €

End cap

9859301	—	flush/with hole	plastic	1,26 €
9859201	—	flush/without hole	plastic	1,26 €

Mounting (package contains 2 pcs.)

9859401		mounting clips	spring steel	1,26 €
---------	--	----------------	--------------	--------



Profiles

Surface Mounted Profile Multi Spot 12
 Adjustable beam angles: 20°, 30°, 60°, 90°
 Suitable for light strips up to 12 mm width

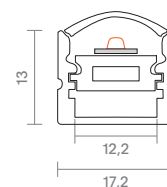

Product Code	Length	Max. Strip Width	Outer dimensions (W x H)	RRP*
--------------	--------	------------------	--------------------------	------

Surface Mounted Profile

9829201	1 m	12 mm	17,2 x 13 mm	20,08 €
9829301	2 m	12 mm	17,2 x 13 mm	39,92 €

Product Code	Length	Style	Material	RRP*
--------------	--------	-------	----------	------

Profile cover, frosted

9865501	1 m	flush	frosted	12,18 €
9865601	2 m	flush	frosted	23,95 €

End cap

9859001	—	flush/with hole	plastic	1,26 €
9858901	—	flush/without hole	plastic	1,26 €

Mounting (package contains 2 pcs.)

9859101		mounting clips	spring steel	2,10 €
---------	--	----------------	--------------	--------



Beam Angle Adjustment

20°

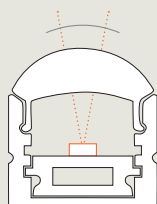

30°

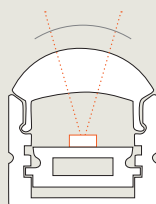

60°

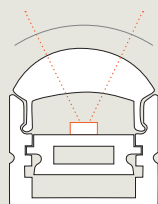

90°

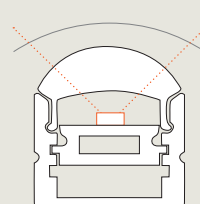

Surface Mounted Profile 12

For wall and ceiling installation

Suitable for light strips up to 12 mm width

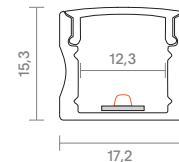

Product Code	Length	Max. Strip Width	Outer dimensions (W x H)	RRP*
--------------	--------	------------------	--------------------------	------

Surface Mounted Profile

9820101	1 m	12,3 mm	17,2 x 15,3 mm	10,00 €
9820201	2 m	12,3 mm	17,2 x 15,3 mm	20,08 €

Product Code	Length	Style	Material	RRP*
--------------	--------	-------	----------	------

Profile cover, opal

9840101	1 m	flush	opal	5,46 €
9840201	2 m	flush	opal	10,00 €

Profile cover, frosted

9862001	1 m	flush	frosted	5,46 €
9862101	2 m	flush	frosted	10,00 €

Profile cover, clear

9830101	1 m	flush	clear	5,46 €
9830201	2 m	flush	clear	10,00 €

End cap

9850101		flush/with hole	plastic	1,26 €
9850201		flush/without hole	plastic	1,26 €

Mounting (package contains 2 pcs.)

9850301		mounting clips	spring steel	1,26 €
---------	--	----------------	--------------	--------

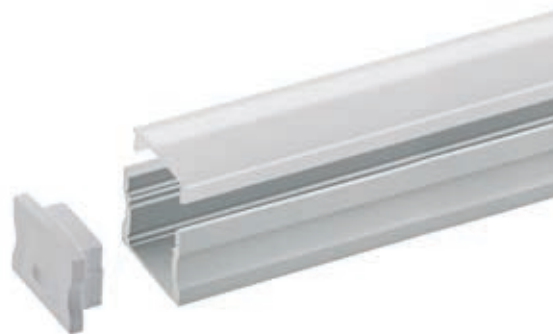

Surface Mounted Profile Flat 12

For wall and ceiling installation

Suitable for light strips up to 12 mm width

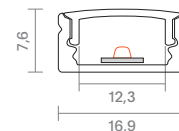

Product Code	Length	Max. Strip Width	Outer dimensions (W x H)	RRP*
--------------	--------	------------------	--------------------------	------

Surface Mounted Profile

9820501	1 m	12,3 mm	16,9 x 7,6 mm	10,00 €
9820601	2 m	12,3 mm	16,9 x 7,6 mm	20,08 €

Product Code	Length	Style	Material	RRP*
--------------	--------	-------	----------	------

Profile cover, opal

9840101	1 m	flush	opal	5,46 €
9840201	2 m	flush	opal	10,00 €

Profile cover, frosted

9862001	1 m	flush	frosted	5,46 €
9862101	2 m	flush	frosted	10,00 €

Profile cover, clear

9830101	1 m	flush	clear	5,46 €
9830201	2 m	flush	clear	10,00 €

End cap

9850701		flush/with hole	plastic	1,26 €
9850801		flush/without hole	plastic	1,26 €

Mounting (package contains 2 pcs.)

9850901		mounting clips	spring steel	1,26 €
---------	--	----------------	--------------	--------



Surface Mounted Profile 13

For wall and ceiling installation etc.
Suitable for light strips up to 13 mm width

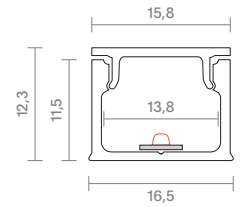

Product Code	Length	Max. Strip Width	Outer dimensions (W x H)	RRP*
--------------	--------	------------------	--------------------------	------

Surface Mounted Profile

9730001	1 m	13 mm	16,5 x 12,3 mm	10,00 €
9730101	2 m	13 mm	16,5 x 12,3 mm	20,08 €

Product Code	Length	Style	Material	RRP*
--------------	--------	-------	----------	------

Profile cover

9732001	1 m	flush	frosted	4,12 €
9732101	2 m	flush	frosted	7,98 €

End cap

9738101		flush/with hole	plastic	1,26 €
9738001		flush/without hole	plastic	1,26 €

Mounting (package contains 2 pcs.)

9739601		mounting clips	spring steel	1,26 €
---------	--	----------------	--------------	--------

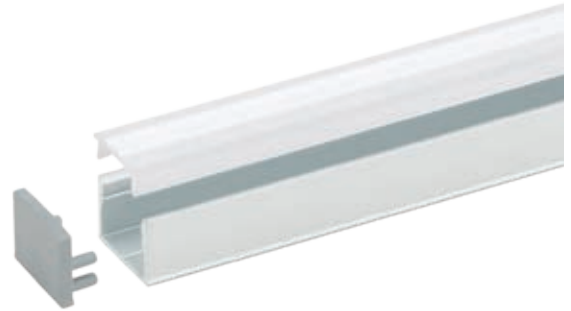

Profiles

Surface Mounted Profile Mounting Rail 15

For wall and ceiling installation
Suitable for light strips up to 15 mm width
Two cover versions: tall or round

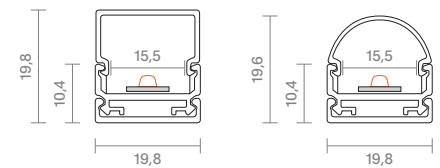

Product Code	Length	Max. Strip Width	Outer dimensions (W x H)	RRP*
--------------	--------	------------------	--------------------------	------

Surface Mounted Profile

9821901	1 m	15,5 mm	19,8 x 10,4 mm	13,03 €
9822001	2 m	15,5 mm	19,8 x 10,4 mm	25,13 €

Product Code	Length	Style	Material	RRP*
--------------	--------	-------	----------	------

Profile cover, tall

9842101	1 m	tall	opal	7,98 €
9842201	2 m	tall	opal	15,88 €
9862301	1 m	tall	frosted	7,98 €
9862401	2 m	tall	frosted	15,88 €
9832101	1 m	tall	clear	7,98 €
9832201	2 m	tall	clear	15,88 €

Profile cover, round

9841901	1 m	round	opal	7,98 €
9842001	2 m	round	opal	15,88 €
9862601	1 m	round	frosted	7,98 €
9865301	2 m	round	frosted	15,88 €
9831901	1 m	round	clear	7,98 €
9832001	2 m	round	clear	15,88 €

End cap, tall

9852801		tall/with hole	plastic	1,26 €
9852901		tall/without hole	plastic	1,26 €

End cap, round

9852601		round/with hole	plastic	1,26 €
9852701		round/without hole	plastic	1,26 €



Surface Mounted Profile High Voltage 15
For high voltage light strips, page 98

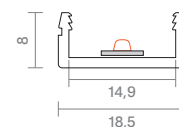

Product Code	Length	Max. Strip Width	Outer dimensions (W x H)	RRP*
--------------	--------	------------------	--------------------------	------

Surface Mounted Profile

9828701	1 m	15 mm	18,5 x 8 mm	7,98 €
9828801	2 m	15 mm	18,5 x 8 mm	15,88 €



Surface Mounted Profile High Voltage 19
For high voltage light strips, page 97

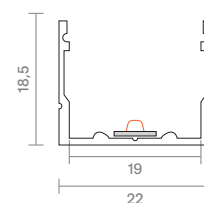

Product Code	Length	Max. Strip Width	Outer dimensions (W x H)	RRP*
--------------	--------	------------------	--------------------------	------

Surface Mounted Profile

9827601	1 m	17 mm	22 x 18,5 mm	7,98 €
9827701	2 m	17 mm	22 x 18,5 mm	15,88 €



Surface Mounted Profile 15

For wall and ceiling installation etc.
Suitable for light strips up to 15 mm width

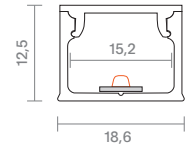

Product Code	Length	Max. Strip Width	Outer dimensions (W x H)	RRP*
--------------	--------	------------------	--------------------------	------

Surface Mounted Profile

9829001	1 m	15 mm	18,6 x 12,5 mm	7,98 €
9829101	2 m	15 mm	18,6 x 12,5 mm	15,88 €

Product Code	Length	Style	Material	RRP*
--------------	--------	-------	----------	------

Profile cover, opal

9846801	1 m	flush	opal	4,12 €
9846901	2 m	flush	opal	7,98 €

Profile cover, clear

9836601	1 m	flush	clear	4,12 €
9836701	2 m	flush	clear	7,98 €

End cap

9857701		flush/with hole	plastic	1,26 €
9857801		flush/without hole	plastic	1,26 €

Mounting (package contains 2 pcs.)

9857901		mounting clips	spring steel	1,26 €
---------	--	----------------	--------------	--------

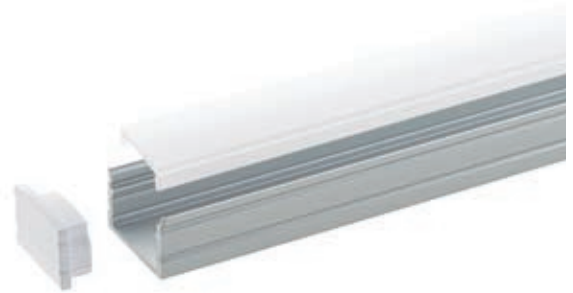

Profiles

Surface Mounted Profile 20

For wall and ceiling installation
Suitable for light strips up to 20 mm width
Suitable for use with double or parallel mounting of two single strips

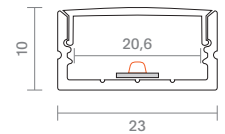

Product Code	Length	Max. Strip Width	Outer dimensions (W x H)	RRP*
--------------	--------	------------------	--------------------------	------

Surface Mounted Profile

9820301	1 m	20,6 mm	23 x 7,7 mm	10,00 €
9820401	2 m	20,6 mm	23 x 7,7 mm	20,08 €

Product Code	Length	Style	Material	RRP*
--------------	--------	-------	----------	------

Profile cover, opal

9840301	1 m	flush	opal	4,12 €
9840401	2 m	flush	opal	7,98 €

Profile cover, clear

9830301	1 m	flush	clear	4,12 €
9830401	2 m	flush	clear	7,98 €

End cap

9850401		flush/with hole	plastic	1,26 €
9850501		flush/without hole	plastic	1,26 €

Mounting (package contains 2 pcs.)

9850601		mounting clips	plastic	1,26 €
---------	--	----------------	---------	--------



Corner Profiles

Aluminum profiles with clear, frosted, or opal covers
For base cabinet, furniture or niche lighting
Passive cooling for light strips
In 1 m and 2 m lengths

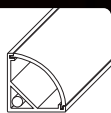

Corner Profile 10
Product code: 9821201
page 111

Corner Profile 10

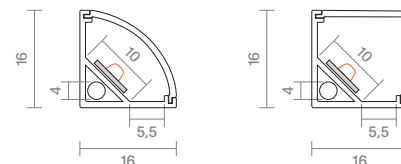

Product Code	Length	Max. Strip Width	Outer dimensions (W x H)	RRP*
--------------	--------	------------------	--------------------------	------

Corner profile

9821101	1 m	10 mm	16 x 16 mm	7,14 €
9821201	2 m	10 mm	16 x 16 mm	13,87 €

Product Code	Length	Style	Material	RRP*
--------------	--------	-------	----------	------

Profile cover, round

9841101	1 m	round	opal	5,80 €
9841201	2 m	round	opal	11,68 €
9863601	1 m	round	frosted	5,80 €
9863701	2 m	round	frosted	11,68 €
9831101	1 m	round	clear	5,80 €
9831401	2 m	round	clear	11,68 €

Profile cover, angled

9841301	1 m	angled	opal	5,80 €
9841401	2 m	angled	opal	11,68 €
9863801	1 m	angled	frosted	5,80 €
9863901	2 m	angled	frosted	11,68 €
9831301	1 m	angled	clear	5,80 €
9831201	2 m	angled	clear	11,68 €

End cap, round

9851901		round/with hole	plastic	1,26 €
9852001		round/without hole	plastic	1,26 €

End cap, angled

9851601		angled/with hole	plastic	1,26 €
9851701		angled/without hole	plastic	1,26 €

Mounting (package contains 2 pcs.)

9851801		mounting clips	spring steel	1,26 €
---------	--	----------------	--------------	--------



Profiles

Corner Profile 20

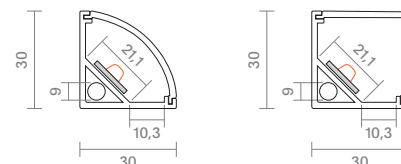

Product Code	Length	Max. Strip Width	Outer dimensions (W x H)	RRP*
--------------	--------	------------------	--------------------------	------

Corner profile

9821501	1 m	21,1 mm	30 x 30 mm	10,84 €
9821601	2 m	21,1 mm	30 x 30 mm	22,27 €

Product Code	Length	Style	Material	RRP*
--------------	--------	-------	----------	------

Profile cover, round

9841501	1 m	round	opal	7,14 €
9841601	2 m	round	opal	13,87 €
9831501	1 m	round	clear	7,14 €
9831601	2 m	round	clear	13,87 €

Profile cover, angled

9841701	1 m	angled	opal	7,14 €
9841801	2 m	angled	opal	13,87 €
9831701	1 m	angled	clear	7,14 €
9831801	2 m	angled	clear	13,87 €

End cap, round

9852101		round/with hole	plastic	1,26 €
9852201		round/without hole	plastic	1,26 €

End cap, angled

9852401		angled/with hole	plastic	1,26 €
9852501		angled/without hole	plastic	1,26 €

Mounting (package contains 2 pcs.)

9852301		mounting clips	plastic	1,26 €
---------	--	----------------	---------	--------



Build-In Profiles

Aluminum profiles for recessed installation
– with clear, frosted, or opal covers
Side wings cover cut and milled edges
Passive cooling for light strips
In 1 m and 2 m lengths

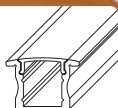

Build-In Profile Flat 12
Product code: 9820801
page 113

Build-In Profile 12

With side wings for recessed installation
Suitable for light strips up to 12 mm width

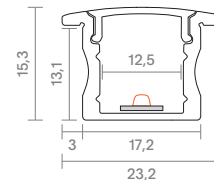

Product Code	Length	Max. Strip Width	Outer dimensions (W x H)	RRP*
--------------	--------	------------------	--------------------------	------

Build-in profile

9825101	1 m	12,5 mm	23,3 x 15,3 mm	11,34 €
9825201	2 m	12,5 mm	23,3 x 15,3 mm	22,27 €

Product Code	Length	Style	Material	RRP*
--------------	--------	-------	----------	------

Profile cover, opal

9840101	1 m	flush	opal	5,46 €
9840201	2 m	flush	opal	10,00 €

Profile cover, frosted

9862001	1 m	flush	frosted	5,46 €
9862101	2 m	flush	frosted	10,00 €

Profile cover, clear

9830101	1 m	flush	clear	5,46 €
9830201	2 m	flush	clear	10,00 €

End cap

9855401		flush/with hole	plastic	1,26 €
9855501		flush/without hole	plastic	1,26 €

Mounting (package contains 2 pcs.)

9850301		mounting clips	spring steel	1,26 €
---------	--	----------------	--------------	--------

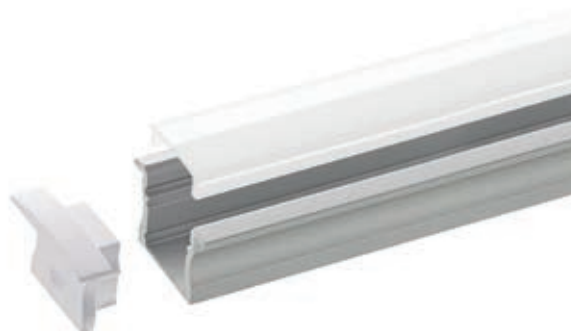

Profiles

Build-In Profile Flat 12

With side wings for recessed installation
Suitable for light strips up to 12 mm width

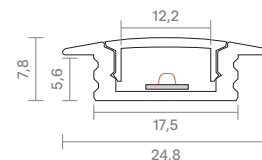

Product Code	Length	Max. Strip Width	Outer dimensions (W x H)	RRP*
--------------	--------	------------------	--------------------------	------

Build-in profile

9820701	1 m	12,2 mm	24,8 x 7,8 mm	7,98 €
9820801	2 m	12,2 mm	24,8 x 7,8 mm	15,88 €

Product Code	Length	Style	Material	RRP*
--------------	--------	-------	----------	------

Profile cover, opal

9840701	1 m	flush	opal	4,12 €
9840801	2 m	flush	opal	7,98 €

Profile cover, clear

9830701	1 m	flush	clear	4,12 €
9830801	2 m	flush	clear	7,98 €

End cap

9851001		flush/with hole	plastic	1,26 €
9851101		flush/without hole	plastic	1,26 €

Mounting (package contains 2 pcs.)

9851201		mounting clips	spring steel	1,26 €
---------	--	----------------	--------------	--------



Wall Profiles

Aluminum profiles for surface mounting
 – with clear, frosted, or opal covers
 For orientation and path illumination
 Passive cooling for light strips
 In 1 m and 2 m lengths

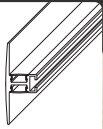

Wall Profile Up and Down 12
 Product code: 9823001
 page 114

Wall Profile Up and Down 12

Up and down lighting for wall mounting
 Suitable for light strips up to 12 mm width
 Two covers are necessary (up and down)

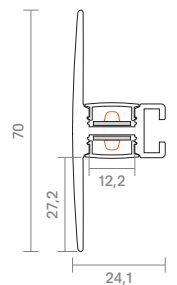

Product Code	Length	Max. Strip Width	Outer dimensions (W x H)	RRP*
--------------	--------	------------------	--------------------------	------

Wall Profile

9822901	1 m	12,2 mm	24,1 x 70 mm	25,13 €
9823001	2 m	12,2 mm	24,1 x 70 mm	50,34 €

Product Code	Length	Style	Material	RRP*
--------------	--------	-------	----------	------

Profile cover, opal

9840701	1 m	flush	opal	4,12 €
9840801	2 m	flush	opal	7,98 €

Profile cover, clear

9830701	1 m	flush	clear	4,12 €
9830801	2 m	flush	clear	7,98 €

End cap

9853701		flush/with hole	plastic	1,26 €
9853801		flush/without hole	plastic	1,26 €

Mounting (package contains 2 pcs.)

9853901		mounting clips	spring steel	4,12 €
---------	--	----------------	--------------	--------



Wall Profile Up or Down 12

Up or down lighting for wall mounting
Suitable for light strips up to 12 mm width

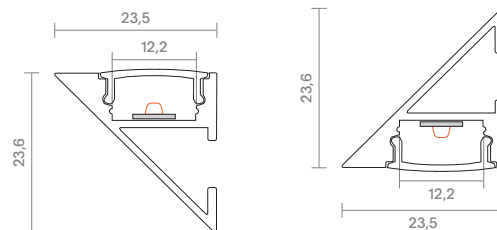

Product Code	Length	Max. Strip Width	Outer dimensions (W x H)	RRP*
Wall Profile				
9824301	1 m	12,2 mm	23,5 x 23,6 mm	7,98 €
9824401	2 m	12,2 mm	23,5 x 23,6 mm	15,88 €

Product Code	Length	Style	Material	RRP*
Profile cover, opal				
9840701	1 m	flush	opal	4,12 €
9840801	2 m	flush	opal	7,98 €
Profile cover, clear				
9830701	1 m	flush	clear	4,12 €
9830801	2 m	flush	clear	7,98 €
End cap				
9854601		flush/with hole	plastic	1,26 €
9854701		flush/without hole	plastic	1,26 €
Mounting (package contains 2 pcs.)				
9853901		mounting clips	spring steel	4,12 €



Profiles

Wall Profile Up and Down 27 Driver

Up and down lighting for wall mounting
Accommodates drivers of up to 40 x 22 mm
Two covers are necessary (up and down)

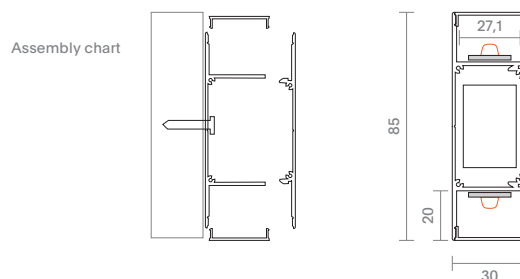

Product Code	Length	Max. Strip Width	Outer dimensions (W x H)	RRP*
Wall Profile				
9822701	1 m	27,1 mm	30 x 85 mm	28,15 €
9822801	2 m	27,1 mm	30 x 85 mm	55,88 €

Product Code	Length	Style	Material	RRP*
Profile cover, opal				
9842701	1 m	flush	opal	5,80 €
9842801	2 m	flush	opal	11,68 €
End cap				
9853501		flush/with hole	plastic	2,10 €
9853601		flush/without hole	plastic	2,10 €



Recessed Profiles

Aluminum profiles for recessed mounting
for flush installations in walls and ceilings
Passive cooling for light strips
In 1 m and 2 m lengths

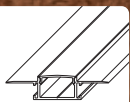

Recessed Profile 10
Product code: 9826601
page 117

Recessed Profile 10 Including Frosted Cover
Suitable for light strips up to 10 mm width

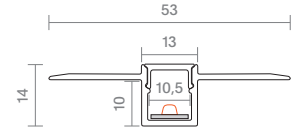

Product Code	Length	Max. Strip Width	Outer dimensions (W x H)	RRP*
--------------	--------	------------------	--------------------------	------

Recessed Profile

9826501	1 m	10,5 mm	53 x 14 mm	23,95 €
9826601	2 m	10,5 mm	53 x 14 mm	47,82 €

Product Code	Style	Material	RRP*
--------------	-------	----------	------

End cap

9855901	flush/with hole	plastic	2,10 €
9856001	flush/without hole	plastic	2,10 €



Recessed profile 20 Including Frosted Cover
Suitable for light strips up to 20 mm width

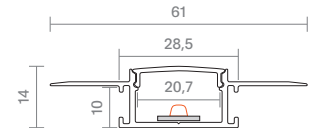

Product Code	Length	Max. Strip Width	Outer dimensions (W x H)	RRP*
--------------	--------	------------------	--------------------------	------

Recessed Profile

9826201	1 m	20 mm	61 x 14 mm	29,83 €
9826701	2 m	20 mm	61 x 14 mm	60,08 €

Product Code	Style	Material	RRP*
--------------	-------	----------	------

End cap

9856101	flush/with hole	plastic	2,10 €
9856201	flush/without hole	plastic	2,10 €



New.

Light Strips Art Profile

Versatile profiles – perfectly adapted for Art light strips, starting page 86

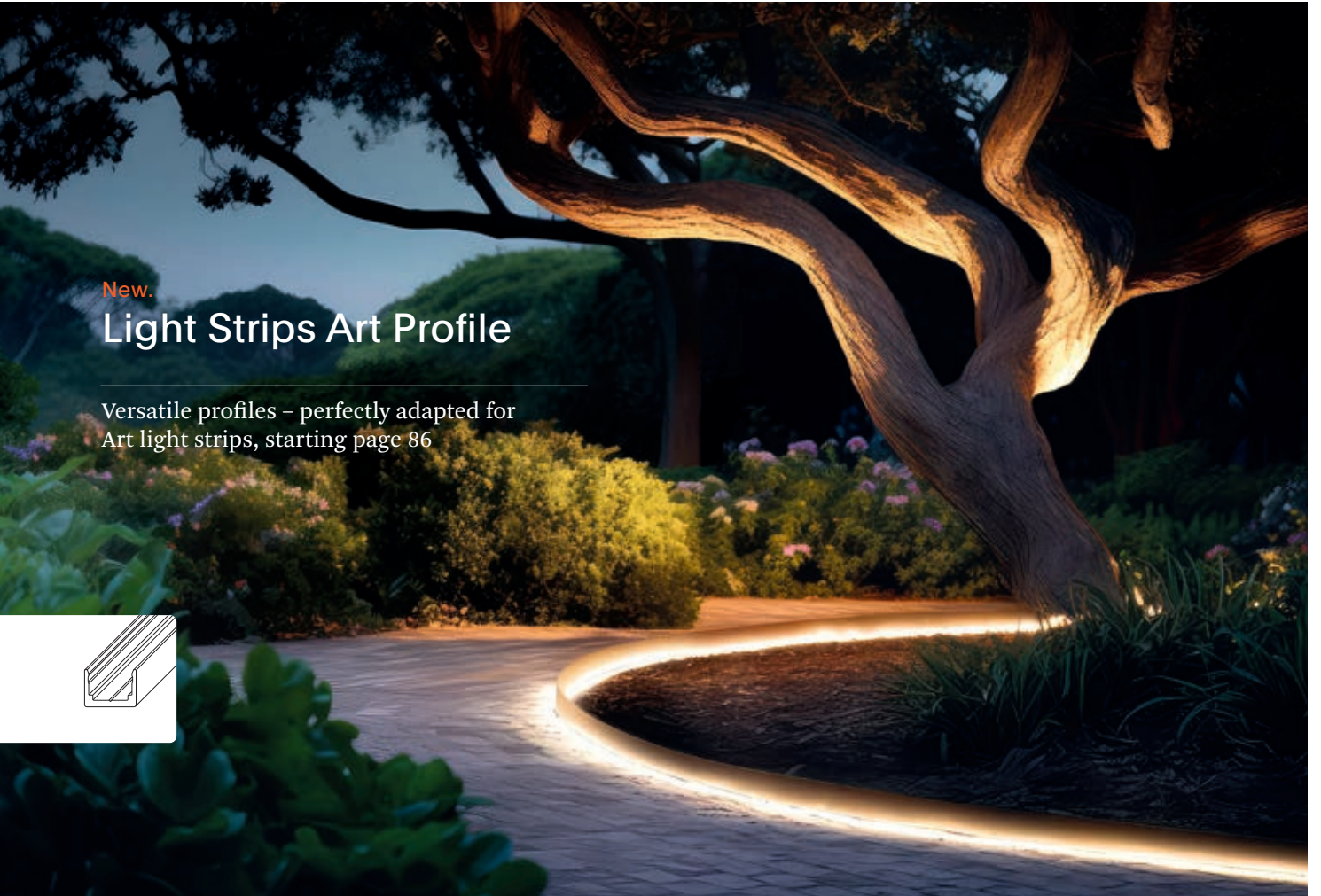
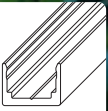

New. Art Light Strip PC Profile 10
Perfect for the Art Omni light strip, page 87

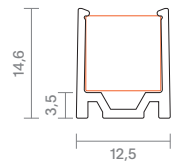

Product Code	Length	Style	Outer dimensions (W x H)	RRP*
9837001	1 m	—	12 x 14,3	7,98 €
9837101	2 m	—	12 x 14,3	15,88 €



New. Light Strips Art Profile 1617
 Perfect for the Art 3D (page 88),
 Top (page 90) and Side (page 92) light strips

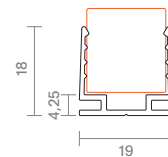

Product Code	Length	Style	Outer dimensions (W x H)	RRP*
9837201	1 m	—	19 x 18 mm	7,98 €
9837301	2 m	—	19 x 18 mm	15,88 €



New. Light Strips Art Profile 1617 Cable Duct
 Perfect for the Art 3D (page 88),
 Top (page 90) and Side (page 92) light strips

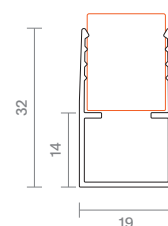

Product Code	Length	Style	Outer dimensions (W x H)	RRP*
9837601	1 m	—	19 x 32 mm	12,52 €
9837701	2 m	—	19 x 32 mm	25,13 €



New. Light Strips Art Profile 1617, Bendable
 Perfect for the Art 3D (page 88),
 Top (page 90) and Side (page 92) light strips

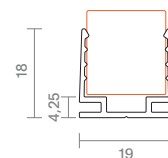

Product Code	Length	Style	Outer dimensions (W x H)	RRP*
9837401	1 m	bendable	19 x 18 mm	12,52 €
9837501	2 m	bendable	19 x 18 mm	25,13 €

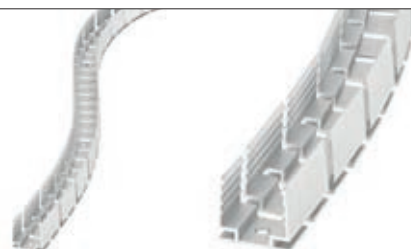



Powerline Driver DALI

—
For smart control solutions
→ p. 122

Powerline Drivers

—
For indoor and outdoor use
→ p. 126



Powerline Drivers TRIAC

—
Compact
Long lifespan
→ p. 124



Drivers

For indoor and outdoor use
Flicker-free and dimmable
Small and compact

Good design thrives on detail – and on what is hidden. Our drivers fade into the background so that the light can take center stage. They are flat, narrow, compact and fit easily into any niche – even directly into the fitting box. TRIAC dimming enables smooth light transitions and creates exactly the mood you want.

Powerline Drivers DALI
p. 122



Powerline Drivers TRIAC
p. 124



Powerline Drivers
p. 126



Powerline Drivers 24 V DALI

Intelligent DALI drivers for indoor and outdoor use: flicker-free, high dimming range, up to 5-year warranty**, and versions with a built-in DALI interface. See page 130 for compatible controllers.

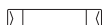

New. Powerline Driver Regular

Flicker-free
DALI-2 (DT6)
High dimming range: 1–100 %
Protected against short circuits, overload, overvoltage, overheating



IP20	3
	Years**

Product Code	Wattage	Input voltage	Output voltage	Output current	L x W x H (mm)	t _c max.	t _s max.	Controller	IP	Appliance Class	RRP*
9214501	60 W	220–240 V AC	24 V DC	2,50 A	223 x 45 x 30	80 °C	40 °C	DALI-2	IP20	II	47,82 €
9214601	100 W	220–240 V AC	24 V DC	4,16 A	308 x 46 x 30	80 °C	40 °C	DALI-2	IP20	II	61,26 €
9214701	150 W	220–240 V AC	24 V DC	6,25 A	308 x 46 x 30	80 °C	40 °C	DALI-2	IP20	II	71,34 €

Powerline Driver, Single Color

Integrated DALI Interface
DT6 compatible
Suitable for commercial DALI Masters
High dimming range: 1–100 %
Protected against short circuits, overload, overvoltage, overheating



	5
	Years**

Product Code	Wattage	Input voltage	Output voltage	Output current	L x W x H (mm)	t _c max.	t _s max.	Controller	IP	RRP*
9057301	75 W	200–240 V AC	24 V DC	3,13 A	306 x 43 x 30	85 °C	50 °C	DALI	IP20	89,83 €
9057401	100 W	200–240 V AC	24 V DC	4,17 A	307 x 43 x 30	85 °C	50 °C	DALI	IP20	99,92 €
9057501	150 W	200–240 V AC	24 V DC	6,25 A	367 x 43 x 30	85 °C	50 °C	DALI	IP20	109,16 €

** Consumer warranty only. Warranty conditions on page 258.

Powerline Driver TW

—
 Integrated DALI Interface
 DT8 compatible
 Suitable for commercial DALI Masters
 High dimming range: 1–100 %
 Protected against short circuits, overload, overvoltage, overheating



Product Code	Wattage	Input voltage	Output voltage	Output current	L x W x H (mm)	t _c max.	t _a max.	Controller	IP	RRP*
9057601	100 W	200–240 V AC	24 V DC	4,17 A	307 x 43 x 30	85 °C	50 °C	DALI	IP20	109,16 €
9057701	150 W	200–240 V AC	24 V DC	6,25 A	367 x 43 x 30	85 °C	50 °C	DALI	IP20	120,08 €

Powerline Driver RGB/W

—
 Integrated DALI Interface
 DT8 compatible
 Suitable for commercial DALI Masters
 High dimming range: 1–100 %
 Protected against short circuits, overload, overvoltage, overheating



Product Code	Wattage	Input voltage	Output voltage	Output current	L x W x H (mm)	t _c max.	t _a max.	Controller	IP	RRP*
9057801	100 W	200–240 V AC	24 V DC	4,17 A	307 x 43 x 30	85 °C	50 °C	DALI	IP20	120,08 €
9057901	150 W	200–240 V AC	24 V DC	6,25 A	367 x 43 x 30	85 °C	50 °C	DALI	IP20	129,83 €

Powerline Driver Outdoor

—
 Flicker-free
 High dimming range: 1–100 %
 Protected against short circuits, overload, overvoltage, overheating
 Push dimming: analog push button for switching and dimming



Product Code	Wattage	Input voltage	Output voltage	Output current	L x W x H (mm)	t _c max.	t _a max.	Controller	IP	Appliance Class	RRP*
9206301	60 W	100–277 V AC	24 V DC	2,5 A	200 x 78 x 25	85 °C	40 °C	DALI	IP66	I	83,95 €
9209901	100 W	100–277 V AC	24 V DC	4,17 A	232 x 78 x 25	75 °C	40 °C	DALI	IP66	I	107,98 €
9209701	150 W	100–277 V AC	24 V DC	6,25 A	278 x 78 x 25	80 °C	40 °C	DALI	IP66	I	139,92 €
9209801	200 W	100–277 V AC	24 V DC	8,3 A	278 x 78 x 25	80 °C	40 °C	DALI	IP66	I	159,58 €
9206401	300 W	100–277 V AC	24 V DC	12,5 A	302 x 78 x 25	90 °C	40 °C	DALI	IP66	I	210,00 €

** Consumer warranty only. Warranty conditions on page 258.

Powerline Drivers TRIAC

Dimmable driver, can even be installed in fitting boxes. They impress with their compact, flat and narrow design.



Powerline Driver TRIAC Micro

Primarily dimmable using forward or reverse phase dimmers
For installation in fitting boxes
Suitable for furniture installation
Suitable for use with Fusion modules 24 V (page 40)



Product Code	Wattage	Input voltage	Output voltage	Output current	L x W x H (mm)	t _c max.	t _a max.	Lifespan	Dimmable	Appliance Class	RRP*
9042801	12 W	220-240 V AC	24 V DC	0,5 A	50 x 48 x 24	80 °C	50 °C	30.000 hrs	yes	II	12,18 €

Powerline Driver TRIAC Flat

Primarily dimmable using reverse phase dimmers
Flat design

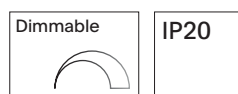

Product Code	Wattage	Input voltage	Output voltage	Output current	L x W x H (mm)	t _c max.	t _a max.	Lifespan	Dimmable	Appliance Class	RRP*
9208201	25 W	180-240 V AC	24 V DC	1,04 A	155 x 54 x 20	85 °C	40 °C	30.000 hrs	yes	II	39,92 €
9208301	50 W	180-240 V AC	24 V DC	2,08 A	178 x 61 x 24	85 °C	40 °C	30.000 hrs	yes	II	60,08 €
9208401	75 W	180-240 V AC	24 V DC	3,13 A	180 x 60 x 35	85 °C	40 °C	30.000 hrs	yes	II	80,25 €

Powerline Driver TRIAC Slim

—
 Primarily dimmable using forward or reverse phase dimmers
 High dimming range: 0–100 %
 Flicker-free
 Narrow design, only 30 mm wide



Product Code	Wattage	Input voltage	Output voltage	Output current	L x W x H (mm)	t _e max.	t _a max.	Lifespan	Dimmable	Appliance Class	RRP*
9200601	30 W	200–240 V AC	24 V DC	1,25 A	260 x 30 x 19	85 °C	40 °C	50.000 hrs	yes	II	50,00 €
9200801	60 W	200–240 V AC	24 V DC	2,5 A	300 x 30 x 19	85 °C	40 °C	50.000 hrs	yes	II	80,25 €
9200901	100 W	200–240 V AC	24 V DC	4,17 A	330 x 30 x 22	85 °C	40 °C	50.000 hrs	yes	II	125,97 €
9201001 New	150 W	200–240 V AC	24 V DC	6,25 A	368 x 30 x 23	85 °C	40 °C	50.000 hrs	yes	II	159,58 €

Powerline Driver TRIAC Base

—
 Primarily dimmable using forward or reverse phase dimmers
 High dimming range: 1–100 %
 Suitable for furniture installation
 Flicker-free



Product Code	Wattage	Input voltage	Output voltage	Output current	L x W x H (mm)	t _e max.	t _a max.	Lifespan	Dimmable	Appliance Class	RRP*
9201801	50 W	220–240 V AC	24 V DC	2,08 A	184 x 61 x 32	75 °C	50 °C	50.000 hrs	yes	II	23,95 €
9201901	100 W	220–240 V AC	24 V DC	4,2 A	210 x 67 x 34	85 °C	45 °C	50.000 hrs	yes	II	60,08 €

Powerline Driver TRIAC Outdoor

—
 Primarily dimmable using forward or reverse phase dimmers
 IP66, for indoor and outdoor use
 Protected against short circuits, overload, overvoltage, overheating

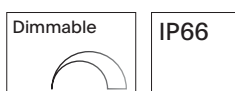

Product Code	Wattage	Input voltage	Output voltage	Output current	L x W x H (mm)	t _e max.	t _a max.	Lifespan	Dimmable	Appliance Class	RRP*
9206501	80 W	180–240 V AC	24 V DC	3,33 A	230 x 70 x 43	75 °C	70 °C	30.000 hrs	yes	I	98,24 €
9208501	100 W	180–240 V AC	24 V DC	4,17 A	230 x 70 x 43	75 °C	70 °C	30.000 hrs	yes	I	109,16 €
9208701	150 W	180–240 V AC	24 V DC	6,25 A	256 x 78 x 47	75 °C	70 °C	30.000 hrs	yes	I	139,92 €
9208801	200 W	180–240 V AC	24 V DC	8,3 A	256 x 78 x 47	75 °C	70 °C	30.000 hrs	yes	I	159,58 €
9208901	360 W	180–240 V AC	24 V DC	15 A	276 x 78 x 47	75 °C	70 °C	30.000 hrs	yes	I	268,82 €

Powerline Drivers

Attractively priced drivers for indoor and outdoor use:
compact, flat or narrow for hassle-free use



Powerline Driver Micro

For installation in fitting boxes
Suitable for furniture installation



IP65



Product Code	Wattage	Input voltage	Output voltage	Output current	L x W x H (mm)	t _c max.	t _a max.	Lifespan	Dimmable	Appliance Class	RRP*
9042701	4 W	200–260 V AC	24 V DC	0,17 A	53 x 27 x 21	80 °C	50 °C	50.000 hrs	no	II	7,98 €

Powerline Driver Flat

Flat design
Suitable for furniture installation
Flicker-free



IP20



Product Code	Wattage	Input voltage	Output voltage	Output current	L x W x H (mm)	t _c max.	t _a max.	Lifespan	Dimmable	Appliance Class	RRP*
9213701	12 W	220–240 V AC	24 V DC	0,5 A	127 x 50 x 12	80 °C	45 °C	30.000 hrs	no	II	11,34 €
9204301	20 W	220–240 V AC	24 V DC	0,63 A	103 x 36 x 17	85 °C	45 °C	30.000 hrs	no	II	15,04 €
9204401	30 W	220–240 V AC	24 V DC	1,25 A	160 x 58 x 18	85 °C	45 °C	30.000 hrs	no	II	19,24 €
9213801	60 W	220–240 V AC	24 V DC	2,08 A	160 x 58 x 18	85 °C	45 °C	30.000 hrs	no	II	23,11 €
9213901	100 W	220–240 V AC	24 V DC	4,16 A	160 x 58 x 18	85 °C	45 °C	30.000 hrs	no	II	37,39 €
9214001	150 W	220–240 V AC	24 V DC	6,25 A	180 x 58 x 20	85 °C	45 °C	30.000 hrs	no	II	47,48 €

Powerline Driver Slim

Narrow design, only 30 mm wide

Suitable for furniture installation



IP20



Product Code	Wattage	Input voltage	Output voltage	Output current	L x W x H (mm)	t _c max.	t _a max.	Lifespan	Dimmable	Appliance Class	RRP*
9214101	30 W	220-240 V AC	24 V DC	1,25 A	251 x 30 x 18	85 °C	45 °C	30.000 hrs	no	II	20,08 €
9214201	60 W	220-240 V AC	24 V DC	2,5 A	305 x 30 x 17	85 °C	45 °C	30.000 hrs	no	II	23,95 €
9204801	100 W	220-240 V AC	24 V DC	4,17 A	320 x 30 x 19	85 °C	45 °C	30.000 hrs	no	II	38,24 €
9204901	150 W	220-240 V AC	24 V DC	6,25 A	360 x 32 x 24	85 °C	45 °C	30.000 hrs	no	II	47,82 €
9214301	200 W	220-240 V AC	24 V DC	8,33 A	360 x 32 x 24	85 °C	45 °C	30.000 hrs	no	II	71,34 €

Powerline Driver Base

Suitable for furniture installation



IP20



Product Code	Wattage	Input voltage	Output voltage	Output current	L x W x H (mm)	t _c max.	t _a max.	Lifespan	Dimmable	Appliance Class	RRP*
9215001	30 W	220-240 V AC	24 V DC	1,25 A	147 x 50 x 25	85 °C	45 °C	30.000 hrs	no	II	12,18 €
9200201	60 W	220-240 V AC	24 V DC	2,5 A	180 x 52 x 30	85 °C	50 °C	30.000 hrs	no	II	15,88 €
9200401	120 W	220-240 V AC	24 V DC	5 A	300 x 40 x 30	90 °C	45 °C	30.000 hrs	no	II	29,83 €
9200501	150 W	220-240 V AC	24 V DC	6,25 A	310 x 40 x 40	85 °C	45 °C	50.000 hrs	no	II	39,92 €

New. Powerline Driver Outdoor

IP67, for indoor and outdoor use

Protected against short circuits, overload, overvoltage, overheating

Integrated Power Factor Correction (PFC) circuit



IP67

Product Code	Wattage	Input voltage	Output voltage	Output current	L x W x H (mm)	t _c max.	t _a max.	Lifespan	Dimmable	Appliance Class	RRP*
9216501	150 W	200-240 V AC	24 V DC	6,25 A	190 x 62 x 47	90 °C	60 °C	50.000 hrs	no	I	86,47 €
9216701	250 W	200-240 V AC	24 V DC	10,4 A	235 x 71 x 47	90 °C	50 °C	50.000 hrs	no	I	125,97 €
9216801	360 W	200-240 V AC	24 V DC	15 A	251 x 71 x 47	90 °C	50 °C	50.000 hrs	no	I	141,93 €

DALI



—
Actuators for professional
lighting projects
→ p. 130



Casambi

—
Smart light control using the
standard Bluetooth protocol
→ p. 132

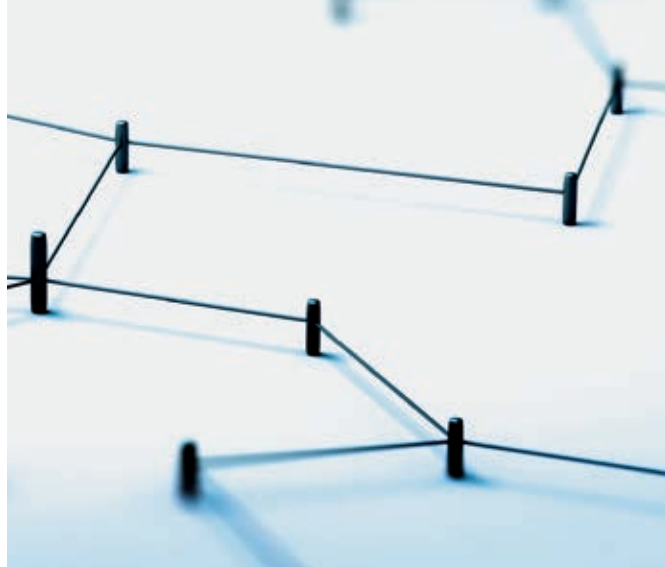

Dimmers

—
Developed for
SIGOR luminants
→ p. 137



Wireless Controller luxigent

—
Wireless control using
high-quality remote controls
→ p. 134

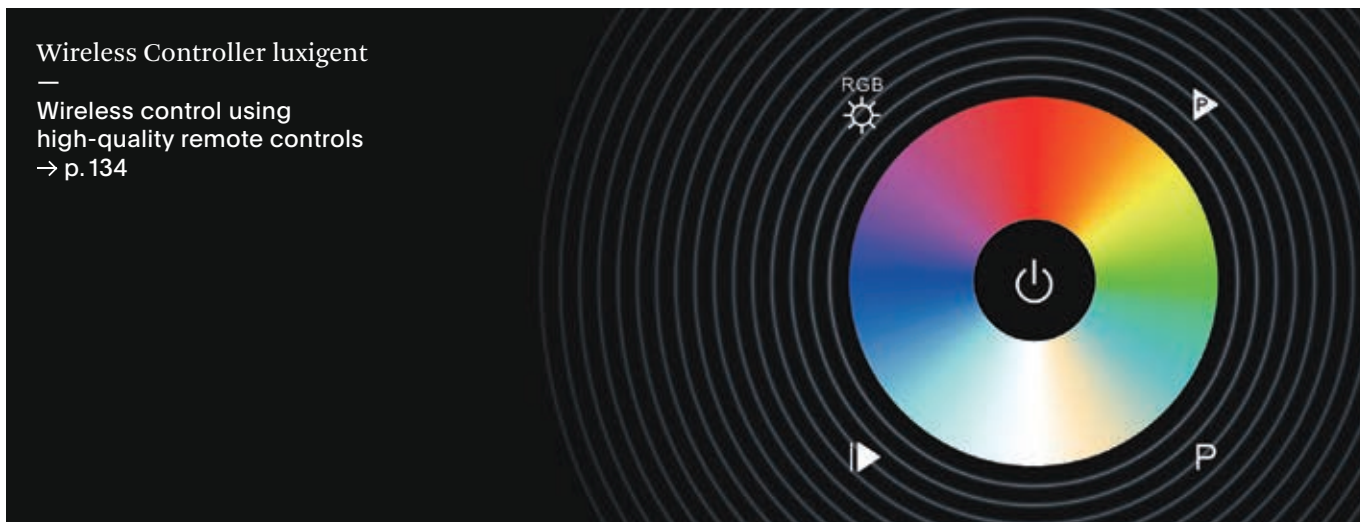

Controllers

Wireless for every space

Casambi or wireless

DALI for professional usage

Hassle-free control

Quality shows in the details. In your private home, in large buildings or in commercial use: Our controllers allow for customized lighting solutions – tailored to your needs, convenient, and efficient.

DALI
p.130



Wireless Controllers
luxigent
p.134



Casambi
p.132



Dimmers
p.137



DALI

The interface for smart lighting solutions.
 The manufacturer-independent DALI standard is used
 when professional, wired luminaires control is required.
 DALI means hassle-free control of all connected components.

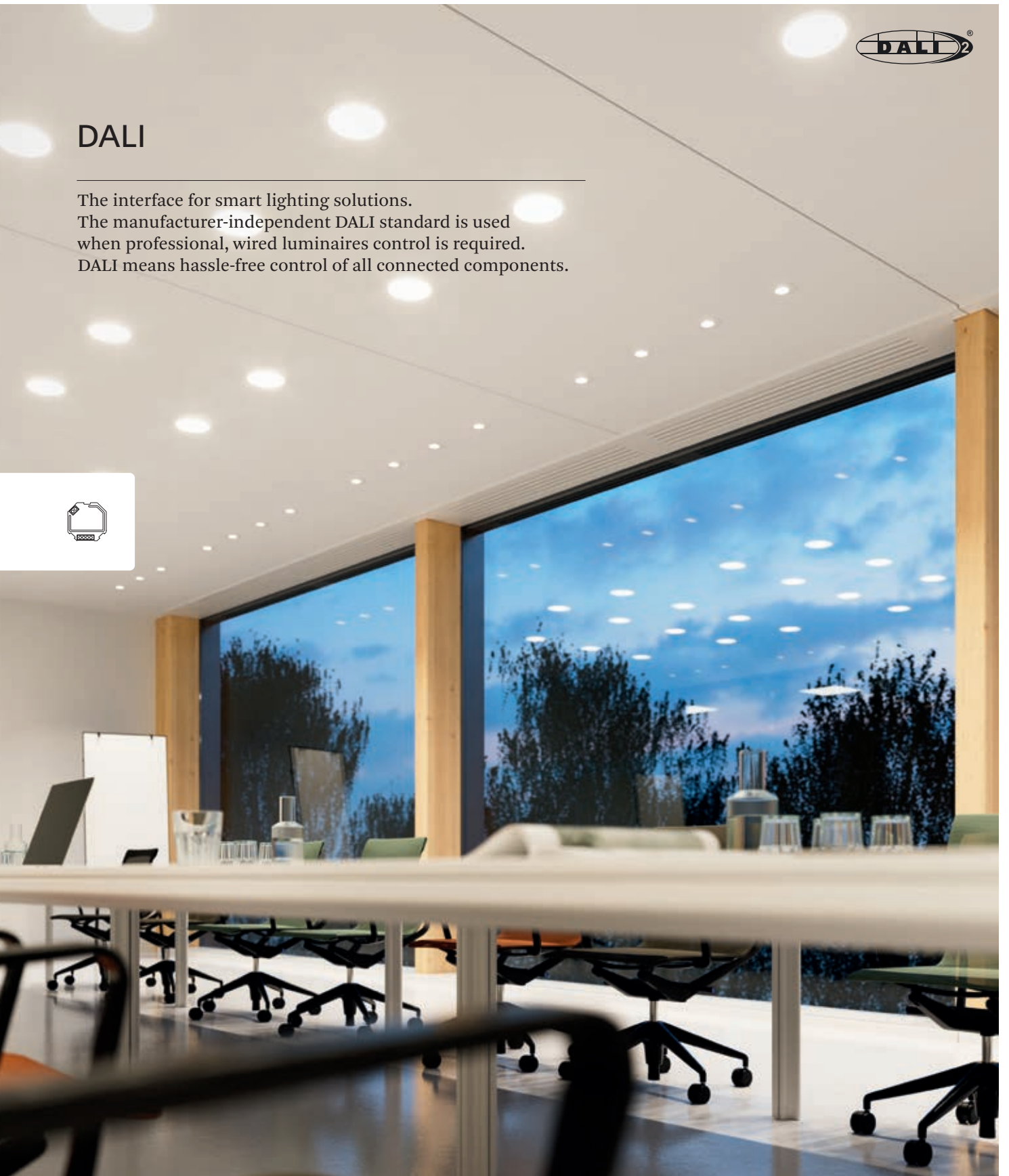
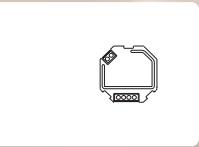

High Voltage Dimmers
 (see p. 131)

Modules, Filament,
 GU10

DALI 24 V Drivers
 (see p. 122)

Light Strip

Receivers
 (see p. 131)

Light Strip

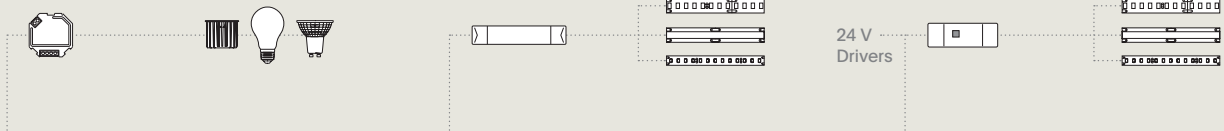

DALI Bus
 +/-

Dimmers

Reverse phase dimmers
 DT6 compatible
 Suitable for commercial DALI controllers
 1 DALI address for controlling the 1 channel output, up to 400 W
 Max. output up to 200 W for LED and halogen low voltage light bulbs;
 up to 400 W for halogen high voltage light bulbs



Product Code	Input voltage	Output voltage	Max. output	Dimensions (L x W x H)	Controller	RRP*
9054301	100–240 V AC	100–240 V AC	max. 400 W	46 x 45 x 20 mm	DALI	57,90 €

Receiver DC/DC, 1 Channel

Dims single-colored lights strips
 DT6 compatible
 Suitable for commercial DALI controllers
 Total output: up to 480 W
 Easy programming on the device or using the master controller
 Dimming range: 1–100 %



Product Code	Input voltage	Output voltage	Max. output	Dimensions (L x W x H)	Controller	RRP*
9057001	12–36 V DC	12–36 V DC	4 x 120 W (24 V)	170 x 53 x 28 mm	DALI	75,21 €

Receiver DC/DC, 4 Channels

Dims lights strips and controls 1 to 4 colors
 Suitable for commercial DALI controllers
 Total output: up to 480 W (24 V)
 Easy programming on the device or using the master controller
 Dimming range: 1–100 %



Product Code	Input voltage	Output voltage	Max. output	Dimensions (L x W x H)	Controller	RRP*
9054101	12–24 V DC	12–24 V DC	4 x 120 W (24 V)	166 x 54 x 23 mm	DALI	75,21 €

Receiver DC/DC, 5 Channels

Dims lights strips and controls 1 to 5 colors
 Switch between DT6 and DT8
 Suitable for commercial DALI controllers
 Total output: up to 600 W (24 V)
 Easy programming on the device or using the master controller
 Dimming range: 1–100 %



Product Code	Input voltage	Output voltage	Max. output	Dimensions (L x W x H)	Controller	RRP*
9057101	12–36 V DC	12–36 V DC	5 x 120 W (24 V)	170 x 59 x 29 mm	DALI	89,50 €

Casambi

Innovative system based on wireless Bluetooth Mesh technology. Can be controlled using the intuitive Casambi app or a convenient light switch. Flexible and powerful system for controlling and automating lamps and other electrical devices that can be used both in home settings and at work.



CASAMBI

Casambi CBU-TED

Casambi reverse phase dimmers

Suitable for installation in fitting boxes



Product Code	Input voltage	Output voltage	Dimensions (L x W x H)	IP	Controller	RRP*
9032501	100–240 V AC	100–240 V AC	40 x 36 x 14 mm	IP20	Casambi	58,74 €

Casambi PWM4WCM

Casambi 4 channel PWM dimmer

Controls up to 4 channels

Ideal for tunable white and RGB/W applications

Max. combined output current 6 A



Product Code	Input voltage	Output voltage	Max. output	Dimensions (L x W x H)	IP	Controller	RRP*
9032701	12–24 V DC	12–24 V DC	144 W/24 V	72,6 x 30 x 18 mm	IP20	Casambi	67,14 €

Casambi DALI CBU-ASD

—
Casambi 1–10 V and DALI controller
DALI: single color, tunable white, RGB, and RGB/W
Suitable for installation in fitting boxes



Product Code	Input voltage	Output voltage	Dimensions (L x W x H)	IP	Controller	RRP*
9032107	220–240 V AC	220–240 V AC	56,5 x 35,8 x 22,3 mm	IP20	Casambi	62,10 €

Casambi DALI CBU-DCS

—
Casambi DALI controller/gateway
Single color, tunable white, RGB, and RGB/W
Powered directly via DALI bus



Product Code	Input voltage	DALI bus max. output	Dimensions (L x W x H)	IP	Controller	RRP*
9033007	9,5–22,5 V DC	250 mA	40,4 x 36,3 x 14 mm	IP20	Casambi	83,95 €

Casambi Push Button Mpress

—
Battery-free and power-free Casambi push button
Does not need power supply or cables
For initial setup, a NFC capable smartphone or tablet is necessary

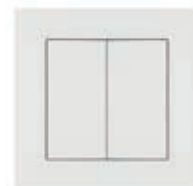

Product Code	Color	Range	Dimensions (L x W x H)	Channels/Zones	Controller	RRP*
9033107	black/RAL 9005	10 m	84 x 84 x 14 mm	2	Casambi	92,35 €
9033207	signal white/RAL 9003	10 m	84 x 84 x 14 mm	2	Casambi	92,35 €
9033307	pure white/RAL 9010	10 m	84 x 84 x 14 mm	2	Casambi	92,35 €

Wireless Controller luxigent

Seamless integration and parallel use of high-quality wall-mounted and hand-held remote controls
Wireless modules for use in existing switch systems
Frequency: 868 MHz

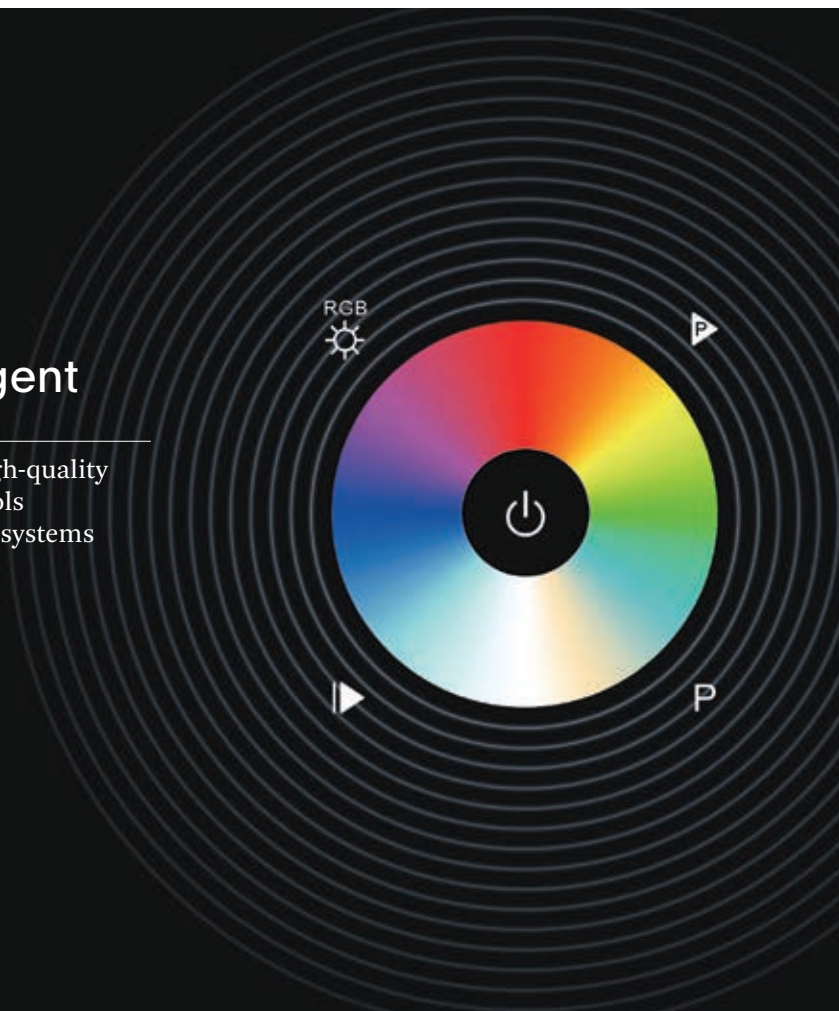

luxigent Handheld Remote Control 1 Channel Puk

1 channel for controlling a lamp or lamp group
High-quality remote control with touch control
Range: 20–30 m
Battery life: 2 years



Product Code	Use	Battery	Dimensions (diameter x H)	Channels/Zones	Color	RRP*
9051901	Handheld remote control, puk, 1 channel, single color	1 x CR2025	39 x 15 mm	1	white	18,07 €

luxigent Handheld Remote Control 1 Channel

1 channel for controlling a lamp or lamp group
High-quality remote control with touch control
Range: 20–30 m
Battery life: 2 years
Memory feature
Wall mount



Product Code	Use	Battery	Dimensions (L x W x H)	Channels/Zones	Color	RRP*
9050001	Handheld remote control, 1 channel, single color	2 x CR2025	141 x 35 x 9 mm	1	black	29,83 €
9050101	Handheld remote control, 1 channel, CCT – Tunable White	2 x CR2025	141 x 35 x 9 mm	1	black	31,85 €

luxigent Handheld Remote Control 4 Channels

—
 Controls up to 4 zones with an unlimited amount of receivers
 High-quality remote control with touch control
 Saves up to 3 scenic settings for each zone
 10 light change modes in each zone, with pause function (RGB/W version)
 Dimming for all or individual colors
 Range: 20–30 m
 Memory feature
 Wall mount



Product Code	Use	Battery	Dimensions (L x W x H)	Channels/Zones	Color	RRP*
9046501	Handheld remote control, 4 channels, single color	3 x AAA	120 x 55 x 17 mm	4	black	55,88 €
9046701	Handheld remote control, 4 channels, CCT – Tunable White	3 x AAA	120 x 55 x 17 mm	4	black	57,90 €
9046601	Handheld remote control, 4 channels, RGB/W	3 x AAA	120 x 55 x 17 mm	4	black	58,74 €

luxigent Handheld Remote Control 4 Channels

—
 Controls up to 4 zones with an unlimited amount of receivers
 High-quality remote control with touch control
 Saves up to 4 scenic settings for each zone
 Dimming for all or individual colors
 Range: 20–30 m
 Memory feature
 Wall mount



Product Code	Use	Battery	Dimensions (L x W x H)	Channels/Zones	Color	RRP*
9052501	Handheld remote control, 4 channels RGB+CCT – Tunable White	3 x AAA	153 x 52 x 19 mm	4	black	75,55 €
9052601	Handheld remote control, 4 channels, RGB/W	3 x AAA	153 x 52 x 19 mm	4	black	64,29 €

luxigent Wall Mounted Remote Control Push Button, 1 Channel

—
 Controls 1 zone with an unlimited amount of receivers
 Flat design with the visual appearance of a normal light switch, no fitting box necessary
 Cover can be removed
 Sender can be integrated into existing switch systems (50 x 50 mm)
 Range: 20–30 m
 Battery life: 2 years
 Memory feature



Product Code	Use	Battery	Dimensions (L x W x H)	Channels/Zones	Color	RRP*
9050501	Wall remote control, push button, 1 channel, single color	CR2430	86 x 86 x 27 mm	1	white	55,88 €

luxigent Wall Mounted Remote Control 1 Channel

—
 Controls 1 zone with an unlimited amount of receivers
 Flat design, no fitting box necessary
 Cover can be removed
 Sender can be integrated into existing switch systems (50 x 50 mm)
 Range: 20–30 m
 Battery life: 2 years



Product Code	Use	Battery	Dimensions (L x W x H)	Channels/Zones	Color	RRP*
9047501	Wall mounted remote control, knob, 1 channel, single color	CR2430	86 x 86 x 27 mm	1	white	55,88 €
9047701	Wall mounted remote control, knob, 1 channel, CCT – Tunable White	CR2430	86 x 86 x 27 mm	1	white	57,90 €

Wireless Receiver luxigent

Universal signal receiver



luxigent Universal Receiver

Receives wireless and WiFi signals
Simultaneous control using a (wireless) remote control, an app or voice commands (WiFi)
Signal control: single color, tunable white, RGB, RGB/W, and RGB/TW



Product Code	Input voltage	Max. output	Max. RC #	Dimensions (L x W x H)	Controller	RRP*
9059001	12–24 V DV	5 x 4 A (96 W at 24 V)	8	145 x 47 x 16 mm	Wireless/WIFI	58,74 €
9059101	12–48 V DV	5 x 8 A (192 W at 24 V)	8	170 x 59 x 29 mm	Wireless/WIFI	80,25 €

luxigent Universal Receiver with Integrated Driver

Less installation hassle with the 50 W driver
Receives wireless signals
Signal control: single color
Easily program up to eight remote controls



Product Code	Input voltage	Output voltage	Max. output	Max. RC #	Dimensions (L x W x H)	Controller	RRP*
9042601	200–240 V AC	24 V DC	1 x 50 W	8	210 x 50 x 32 mm	Wireless	58,74 €

luxigent Universal Receiver 230 V For Lamp Mounting

230 V wireless receiver for installation in lamps or canopies
Compact dimensions: only 45 mm in diameter
Signal control: On/Off, dim
Easily program up to eight remote controls



Product Code	Input voltage	Max. output	Max. RC #	Dimensions (diameter x H)	Controller	RRP*
9052201	200–240 V AC	100 W	8	45 x 20 mm	Wireless	36,05 €

Dimmers

In cooperation with Swedish manufacturer VADSBO, we offer high-quality dimmers that are highly compatible with our LED range. The high-quality components guarantee optimum dimming results.



Rotary Dimmers

Switch insert compatible with the following switch systems:
Gira: Standard 55, E2, Event, Esprit; Jung: A500, Aplus
Merten: M-Smart, M-Arc, M-Plan; Berker: S1, B1, B3, B7 Glas

VD 100

Dimming range: 0–100 % – even with LED light sources
Maximum load: 100 W
Settings: Minimum dim level

VD 300

Dimming range: 0–100 % – even with LED light sources
Maximum load: 300 W
Settings:
Minimum/maximum dim level, flicker, boost feature
for slow-starting appliances



Product Code	Input voltage	Wattage	Requires zero conductor	Dimensions (L x W x H)	Settings	RRP*
Rotary Dimmer VD 100						
9033407 New	220–240 V AC	1–100 W	no	84 x 84 x 45 mm	Minimum dim level	73,87 €
Rotary Dimmer VD 300						
9032101	220–240 V AC	1–300 W	no	87 x 87 x 43 mm	Minimum and maximum dim level, flicker, boost	83,95 €

Push Button Dimmers with Zero Conductor

Dimming range: 0–100 % – even with LED light sources
Maximum load: 200 W (LD220), 440 W (LD440)
3-way switching possible
For use with commercial push button switches
Settings: Minimum dim level
Switch insert compatible with the following switch systems:
Gira: Standard 55, E2, Event, Esprit; Jung: A500, Aplus
Merten: M-Smart, M-Arc, M-Plan; Berker: S1, B1, B3, B7 Glas



Product Code	Input voltage	Wattage	Requires zero conductor	Dimensions (diameter x H)	Settings	RRP*
Push button dimming module LD220						
9032201	220–240 V AC	1–200 W	yes	56 x 22 mm	Minimum dim level	67,14 €
Push button dimming module LD440						
9032301	220–240 V AC	1–440 W	yes	56 x 22 mm	Minimum dim level	83,95 €

Nivo®

—
Surface Mounted Ceiling Luminaire
→ p. 142



Nivo®

—
Pendant Luminaire
→ p. 148



Nivo®

—
Table Lamp
→ p. 150



Nivo®

—
Recessed Ceiling Luminaire,
111 mm
→ p. 144



Nivo®

—
Accessories
→ P. 152



Nivo®

One lens, so many options The new luminaire series for demanding projects

The Nivo® series allows for a homogenous illumination and high precision with clearly defined beam angles. Its high-tech hybrid lens, which was developed in cooperation with the Bartenbach Institut, combines lens and reflector in one component. With its clear, minimalist shape and its balanced proportions, the Nivo® series stands out with its timeless design. The successful blend of high-quality surfaces, easy installation and state-of-the-art lighting technology makes the Nivo® the perfect choice for sophisticated living and working spaces.

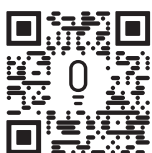

Nivo®
Surface Mounted
Ceiling Luminaire
p. 142

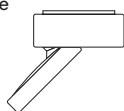

Nivo®
Pendant Luminaire
p. 148

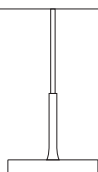

Nivo®
Accessories
p. 152



Nivo®
Recessed Ceiling Luminaire,
111 mm
p. 144

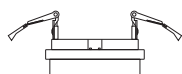

Nivo®
Table Lamps
p. 150

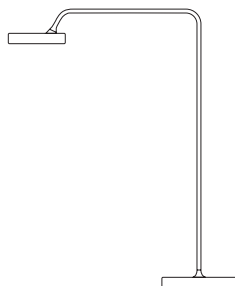

Nivo®
Recessed Ceiling Luminaire,
142 mm
p. 146

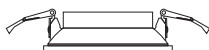

Nivo®

Light With New Precision

A new form of lighting: The Nivo® luminaire series allows for a homogenous illumination and high precision with clearly defined beam angles and a homogenous light cone without scattered light, free of artificial artefacts, and with a gently tapering edge. Precisely calculated microfacets direct the light rays and ensure uniform, streak-free light distribution.

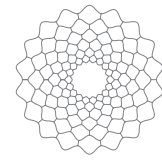

Inspired by nature:
organic lens design

Its secret: an innovative high-tech hybrid lens – heart and head of this luminaire series. It is based on an innovative optical principle that optimally combines the physical effects of refraction and reflection.

Ceiling Luminaires



Surface Mounted
Ceiling Luminaire,
Swiveling



Recessed Ceiling
Luminaire, 111 mm
Swiveling



Recessed Ceiling
Luminaire, 111 mm
Flush with Ceiling,
Swiveling



Recessed Ceiling
Luminaire, 111 mm
Fixed



Recessed Ceiling
Luminaire, 111 mm
Flush with Ceiling,
Fixed



Recessed Ceiling
Luminaire, 142 mm
Swiveling



Recessed Ceiling
Luminaire, 142 mm
Flush with Ceiling,
Swiveling

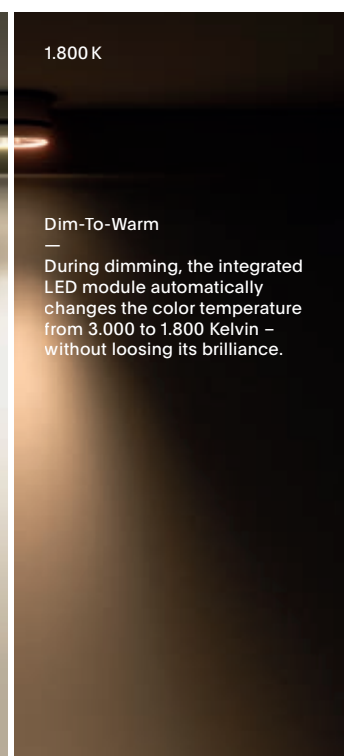
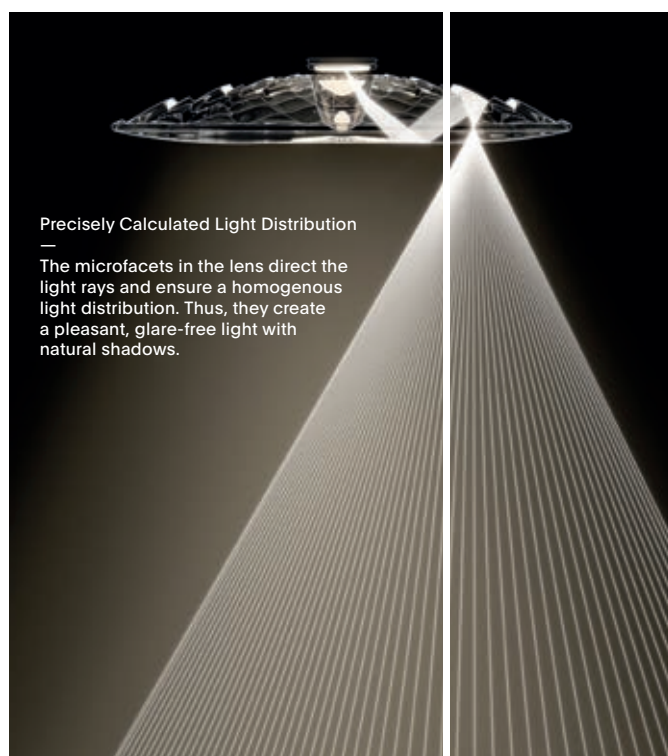

Pendant Luminaires



Pendant Luminaire
Surface Mounted

Pendant Luminaire
Recessed

Pendant Luminaire
Recessed,
Flush with Ceiling



Lens front made from
optical polycarbonate



Table Lamp



Light Direction

For all swiveling luminaires and the table lamp, the lens module can be tilted up to 45° thanks to the asymmetrical suspension in the module insert. At the same time, the module insert can be rotated by up to 360°, allowing the light focus to be precisely aligned over a large area.

Material

—
Matte soft-touch surface
in black or white

Mounting

—
Feed-through wiring
using a connection rail



Nivo® Surface Mounted Ceiling Luminaire

The surface mounted Nivo® versions can be directly connected to a 230 V power supply in a few simple steps. With the extensive range of accessory options, several spotlights can be flexibly connected in all directions. The innovative swivel and tilt mechanism allows the spot-lights to be precisely adjusted in terms of direction and angle.



High color rendering, Ra 90
 Dim-To-Warm technology
 High-tech hybrid lens
 Homogeneous light distribution – pleasant, glare-free light
 Extremely bright: 970 lm
 TÜV Rheinland certified

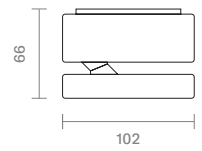

Connect surface mounted luminaires either directly or using a rail
 (see Accessories on page 153)



Nivo® Surface Mounted Ceiling Luminaire, Swiveling

Module insert tilting angle up to 45°
 Module insert swivel angle up to 360°
 Integrated 350 mA driver



Nivo®

Dim-To-Warm 	Ra 90 	IP30	50.000 hrs L80/B10	5 Years**
-----------------	-----------	------	-----------------------	--------------

Product Code	Color	Dimensions (diameter x H)	Wattage	Input	Color Temp.	Luminous Flux	CRI	Dimmable	Angle	RRP*
4810001	matte black	102 x 66 mm	14 W	220–240 V AC~50 Hz	3.000–1.800 K	970 lm	90	yes	36°	234,45 €
4810201	matte black	102 x 66 mm	14 W	220–240 V AC~50 Hz	3.000–1.800 K	950 lm	90	yes	50°	234,45 €
4810101	soft white	102 x 66 mm	14 W	220–240 V AC~50 Hz	3.000–1.800 K	970 lm	90	yes	36°	234,45 €
4810301	soft white	102 x 66 mm	14 W	220–240 V AC~50 Hz	3.000–1.800 K	950 lm	90	yes	50°	234,45 €

This lamp contains built-in LED bulbs. The light source of this luminaire can only be replaced by SIGOR Licht GmbH or a similarly qualified person (EN 60598-1 3.3.21).
 ** Consumer warranty only. Warranty conditions on page 258.

Nivo® Recessed Ceiling Luminaire, 111 mm

With a diameter of 111 mm and a floral-inspired high-tech hybrid lens, they are not only completely glare-free, but also a real eye-catcher. With the optional mounting ring, the Nivo® recessed ceiling luminaires virtually disappear in the ceiling.



High color rendering, Ra 90
 Dim-To-Warm technology
 High-tech hybrid lens
 Homogeneous light distribution – pleasant, glare-free light
 Extremely bright: 970 lm
 Includes external, dimmable driver
 with plug connection, connection cable: 380 mm
 TÜV Rheinland certified

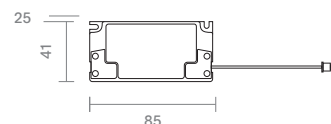
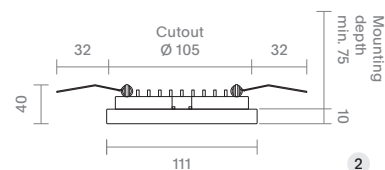
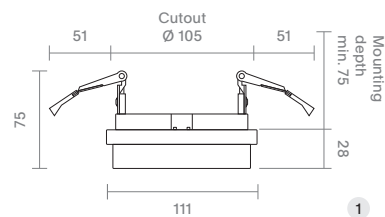

Mounting flush with ceiling using the mounting ring (see Accessories on page 153)



Alternatively DALI-2 driver: 117 x 41 x 24 mm (L x W x H) (see Accessories on page 153)



Nivo® Recessed Ceiling Luminaire, Swiveling, 111 mm

Module insert tilting angle up to 45°
 Module insert swivel angle up to 360°



Dim-To-Warm	Ra 90	IP30	50.000 hrs L80/B10	5 Years**
-------------	-------	------	-----------------------	--------------

Product Code	Color	Dimensions (diameter x H)	Wattage	Input	Color Temp.	Luminous Flux	CRI	Dimmable	Angle	RRP*
4811001	matte black	111 x 75 mm	14 W	35 V DC/350 mA	3.000–1.800 K	970 lm	90	yes	36°	167,23 €
4811201	matte black	111 x 75 mm	14 W	35 V DC/350 mA	3.000–1.800 K	950 lm	90	yes	50°	167,23 €
4811101	soft white	111 x 75 mm	14 W	35 V DC/350 mA	3.000–1.800 K	970 lm	90	yes	36°	167,23 €
4811301	soft white	111 x 75 mm	14 W	35 V DC/350 mA	3.000–1.800 K	950 lm	90	yes	50°	167,23 €

Nivo® Recessed Ceiling Luminaire, Fixed, 111 mm



Dim-To-Warm	Ra 90	IP30	50.000 hrs L80/B10	5 Years**
-------------	-------	------	-----------------------	--------------

Product Code	Color	Dimensions (diameter x H)	Wattage	Input	Color Temp.	Luminous Flux	CRI	Dimmable	Angle	RRP*
4811401	matte black	111 x 40 mm	14 W	35 V DC/350 mA	3.000–1.800 K	970 lm	90	yes	36°	142,02 €
4811601	matte black	111 x 40 mm	14 W	35 V DC/350 mA	3.000–1.800 K	950 lm	90	yes	50°	142,02 €
4811501	soft white	111 x 40 mm	14 W	35 V DC/350 mA	3.000–1.800 K	970 lm	90	yes	36°	142,02 €
4811701	soft white	111 x 40 mm	14 W	35 V DC/350 mA	3.000–1.800 K	950 lm	90	yes	50°	142,02 €

This lamp contains built-in LED bulbs. The light source of this luminaire can only be replaced by SIGOR Licht GmbH or a similarly qualified person (EN 60598-1 3.3.21).
 ** Consumer warranty only. Warranty conditions on page 258.

Nivo® Recessed Ceiling Luminaire, 142 mm

With a diameter of 142 mm and a floral-inspired high-tech hybrid lens, they are not only completely glare-free, but also a real eye-catcher. With the optional mounting ring, the Nivo® recessed ceiling luminaires virtually disappear in the ceiling.

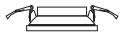

High color rendering, Ra 90
 Dim-To-Warm technology
 High-tech hybrid lens
 Homogeneous light distribution – pleasant, glare-free light
 Extremely bright: 970 lm
 Includes external, dimmable driver
 with plug connection, connection cable: 380 mm
 TÜV Rheinland certified

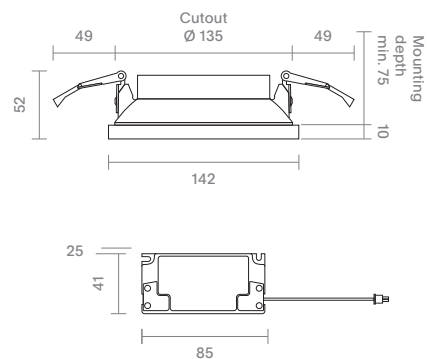

Mounting flush with ceiling using
 the mounting ring
 (see Accessories on page 153)

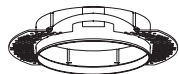

Alternatively DALI-2 driver:
 117 x 41 x 24 mm (L x W x H)
 (see Accessories on page 153)



Nivo® Recessed Ceiling Luminaire, Swiveling, 142 mm

Module insert tilting angle up to 45°
 Module insert swivel angle up to 360°



Dim-To-Warm	Ra 90	IP30	50.000 hrs	5
			L80/B10	Years**

Product Code	Color	Dimensions (diameter x H)	Wattage	Input	Color Temp.	Luminous Flux	CRI	Dimmable	Angle	RRP*
4810401	matte black	142 x 45 mm	14 W	35 V DC/350 mA	3.000–1.800 K	970 lm	90	yes	36°	184,03 €
4810601	matte black	142 x 45 mm	14 W	35 V DC/350 mA	3.000–1.800 K	950 lm	90	yes	50°	184,03 €
4810501	soft white	142 x 45 mm	14 W	35 V DC/350 mA	3.000–1.800 K	970 lm	90	yes	36°	184,03 €
4810701	soft white	142 x 45 mm	14 W	35 V DC/350 mA	3.000–1.800 K	950 lm	90	yes	50°	184,03 €

This lamp contains built-in LED bulbs. The light source of this luminaire can only be replaced by SIGOR Licht GmbH or a similarly qualified person (EN 60598-1 3.3.21).
 ** Consumer warranty only. Warranty conditions on page 258.

Nivo® Pendant Luminaire

With its clear, minimalist design, this pendant luminaire fits into any room – both in its recessed and surface-mounted versions. With up to 970 lm, Dim-To-Warm technology and microfacets in its lens module, it creates natural, glare-free light.

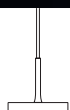

High color rendering, Ra 90
 Dim-To-Warm technology
 High-tech hybrid lens
 Homogeneous light distribution – pleasant, glare-free light
 Extremely bright: 970 lm
 High-quality silicon cable, 2.400 mm, can be cut to any length
 TÜV Rheinland certified

Connect surface mounted pendant luminaires using a rail; junction box centered (see Accessories on page 153)



For recessed luminaires, alternatively DALI-2 driver: 117 x 41 x 24 mm (L x W x H) (see Accessories on page 153)

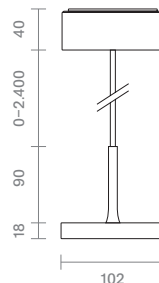
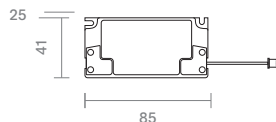

1

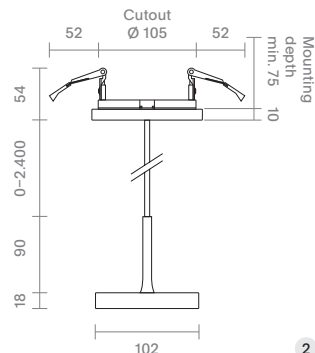

2

Nivo® Surface Mounted Pendant Luminaire

Integrated 350 mA driver

Dim-To-Warm	Ra 90	IP30	50.000 hrs L80/B10	5 Years**
-------------	-------	------	-----------------------	--------------



Product Code	Color	Dimensions (diameter x H)	Wattage	Input	Color Temp.	Luminous Flux	CRI	Dimmable	Angle	RRP*
4812001	matte black	102 x 148–2.548 mm	14 W	220–240 V AC~50 Hz	3.000–1.800 K	970 lm	90	yes	36°	234,45 €
4812201	matte black	102 x 148–2.548 mm	14 W	220–240 V AC~50 Hz	3.000–1.800 K	950 lm	90	yes	50°	234,45 €
4812101	soft white	102 x 148–2.548 mm	14 W	220–240 V AC~50 Hz	3.000–1.800 K	970 lm	90	yes	36°	234,45 €
4812301	soft white	102 x 148–2.548 mm	14 W	220–240 V AC~50 Hz	3.000–1.800 K	950 lm	90	yes	50°	234,45 €

Nivo® Recessed Pendant Luminaire

Mounting flush with ceiling using the mounting ring (see Accessories on page 153)
 Includes external, dimmable driver with plug connection, connection cable: 380 mm

Dim-To-Warm	Ra 90	IP30	50.000 hrs L80/B10	5 Years**
-------------	-------	------	-----------------------	--------------



Product Code	Color	Dimensions (diameter x H)	Wattage	Input	Color Temp.	Luminous Flux	CRI	Dimmable	Angle	RRP*
4812401	matte black	102 x 162–2.562 mm	14 W	35 V DC/350 mA	3.000–1.800 K	970 lm	90	yes	36°	234,45 €
4812601	matte black	102 x 162–2.562 mm	14 W	35 V DC/350 mA	3.000–1.800 K	950 lm	90	yes	50°	234,45 €
4812501	soft white	102 x 162–2.562 mm	14 W	35 V DC/350 mA	3.000–1.800 K	970 lm	90	yes	36°	234,45 €
4812701	soft white	102 x 162–2.562 mm	14 W	35 V DC/350 mA	3.000–1.800 K	950 lm	90	yes	50°	234,45 €

This lamp contains built-in LED bulbs. The light source of this luminaire can only be replaced by SIGOR Licht GmbH or a similarly qualified person (EN 60598-1 3.3.21).
 ** Consumer warranty only. Warranty conditions on page 258.

Nivo® Table Lamp

Flexible and bright: As a table lamp with head and arm that can be swiveled, the Nivo® provides glare-free lighting on desks, tables and working areas in all living and working spaces.



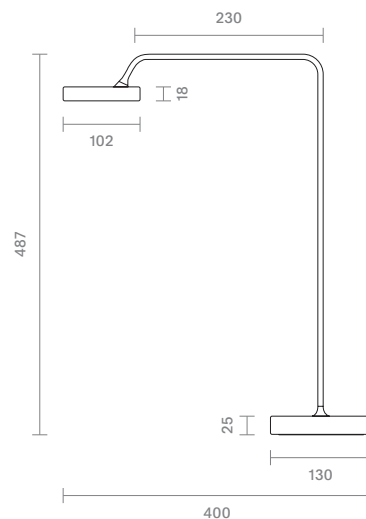

High color rendering, Ra 90
 Dim-To-Warm technology
 High-tech hybrid lens
 Homogeneous light distribution – pleasant, glare-free light
 Includes power adapter and connection cable (2 m)



Nivo® Table Lamp

Lamp head tilting angle up to 45°
 Lamp arm swivel angle up to 360°

 Dim-To-Warm	 Ra 90	 IP30	 50.000 hrs L80/B10	 5 Years**
---	---	--	---	--



Product Code	Color	Dimensions (W x H)	Wattage	Input	Color Temp.	Luminous Flux	CRI	Dimmable	Angle	RRP*
4813001	matte black	400 x 487 mm	12 W	40 V DC/300 mA	3.000–1.800 K	800 lm	90	yes	50°	419,33 €
4813101	soft white	400 x 487 mm	12 W	40 V DC/300 mA	3.000–1.800 K	800 lm	90	yes	50°	419,33 €

This lamp contains built-in LED bulbs. The light source of this luminaire can only be replaced by SIGOR Licht GmbH or a similarly qualified person (EN 60598-1 3.3.21).
 ** Consumer warranty only. Warranty conditions on page 258.

Nivo® Accessories

The Nivo® Luminaire Series comes with a wide range of accessories for easy installation and flexible use – from connection rails for mounting in a line up to exchangeable lens modules.

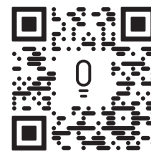
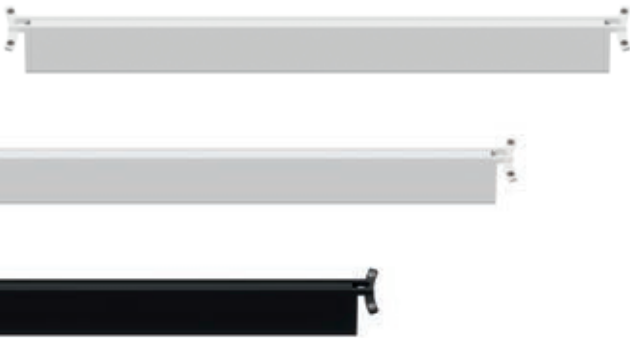

Watch the video:
Opening/Closing the Luminaire



Mounting Ring

Fine-tuning using adjusting screws 9–25 mm

Product Code	Size	RRP*
1 4815001	for ceiling luminaire 111, cutout Ø 120 mm	37,82 €
2 4815101	for ceiling luminaire 142, cutout Ø 150 mm	49,58 €



1

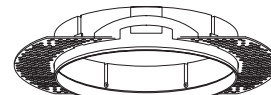

2

Junction Box

For variable connection of several surface mounted spotlights using direct connectors or a connection rail
Can accommodate: Casambi CBU-TED Dimmer (see page 132), DALI build-in dimmer (see page 131)

Product Code	Color	RRP*
4815301	matte black	41,18 €
4815201	soft white	41,18 €

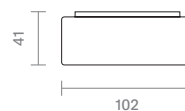

Direct Connector

Includes connection cable and screws

Product Code	Color	RRP*
4816801	matte black	10,92 €
4816901	soft white	10,92 €

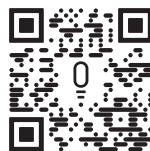

Watch the video:
Mounting of Direct Connector

Connection Rail

Connection rail with matching design in three lengths
Includes connection cable and screws

Product Code	Color	Length	RRP*
4815401	matte black	300 mm	54,62 €
4815501	matte black	600 mm	73,11 €
4815601	matte black	900 mm	94,96 €
4815701	soft white	300 mm	54,62 €
4815801	soft white	600 mm	73,11 €
4815901	soft white	900 mm	94,96 €

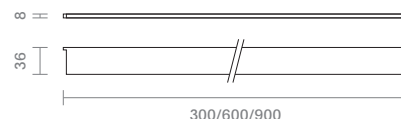
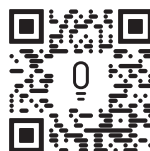

Watch the video:
Mounting of Mounting Rail

Replacement Lens with Magnet Holder

Product Code	Color	Half-value angle	RRP*
4816001	matte black	36°	36,97 €
4816101	matte black	50°	36,97 €
4816401	soft white	36°	36,97 €
4816501	soft white	50°	36,97 €

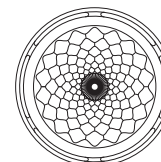
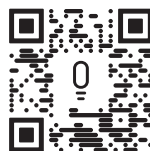

Watch the video:
Replacing the Lens

Upgrade for Nivo® Recessed Luminaires Upgrade to DALI-2 Luminaires

Product Code	Dimensions (L x W x H)	RRP*
4816611	117 x 41 x 24 mm	38,66 €

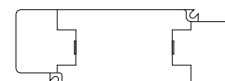

Damp-Proof Luminaire Tricolor

—
Robust, durable and
low-maintenance
→ p. 192

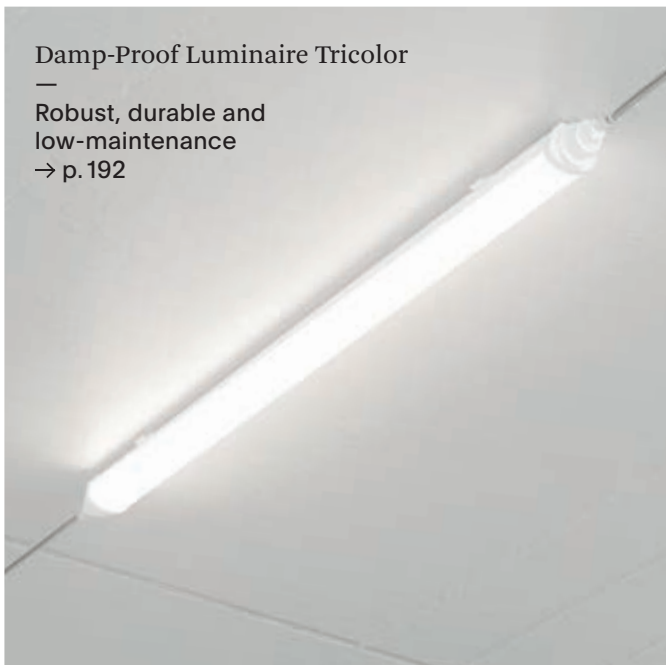

Surface Mounted Luminaire Disc

—
Minimalist design with
a wide range of options
→ p. 182



Recessed Panel Fled Backlit 9in1

—
Three output levels, three color temperatures,
maximum flexibility
→ p. 172



Downlight 68 Diled – 6 W

—
Compact module with
ultra-shallow mounting depth
→ p. 158

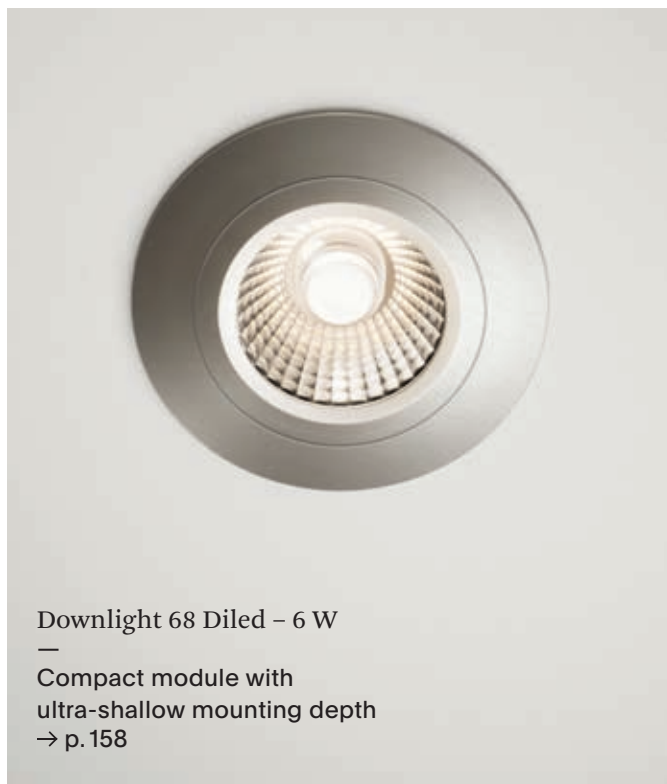

Downlight IP54 Argent

—
For use in wet and
damp environments
→ p. 166

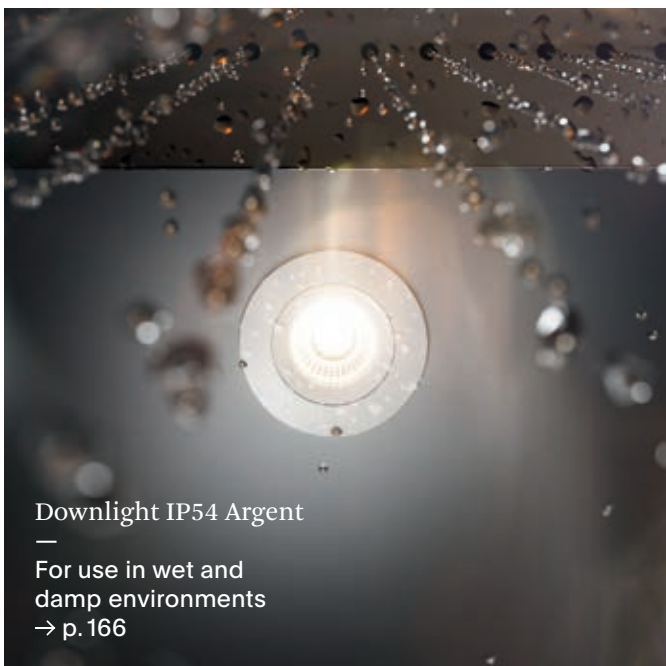

Surface Mounted Luminaire Square

—
Timeless ceiling luminaire
in a square style
→ p. 183

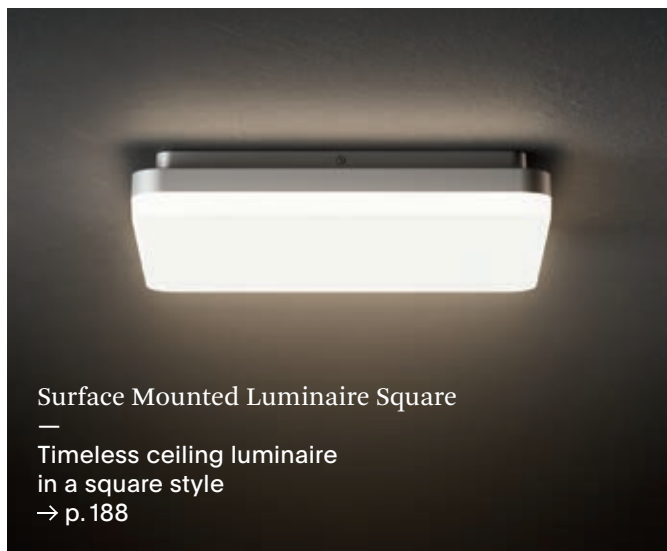

Architectural Lights

Recessed luminaires with integrated driver and a brilliant reflector Surface mounted light panels for offices and warehouses: easy to mount and extremely flat

Lighting professionals don't just want the right light: It's also important that installation is as easy as possible, especially for big projects. With our smart mounting systems, we facilitate installation. Our surface mounted panels with integrated driver are so flat – they almost recede into the ceiling. Surface mounted or recessed, round or square: We always have the right product.



Downlight 60 Diled
p. 156



Downlight IP54 Argent
p. 166



Surface Mounted Panel
Fled, square
p. 176

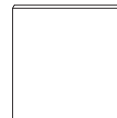

Surface Mounted
Luminaire Circel
p. 186

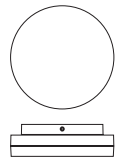

Downlight 68 Diled – 6 W
p. 158



Downlight Fled
p. 168

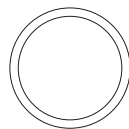

Surface Mounted Panel
Fled, rectangular
p. 178



Surface Mounted
Luminaire Square
p. 188

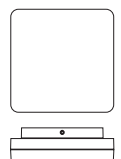

Downlight 68 Diled Low Glare
p. 160

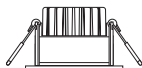

Downlight Fled Slim
p. 170



Surface Mounted
Luminaire Plank
p. 180

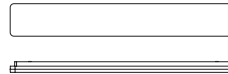

Surface Mounted
Luminaire Moon
p. 190

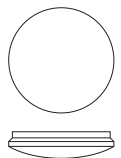

Downlight 68 Diled – 10 W
p. 162

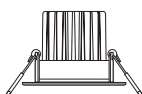

Recessed Panel
Fled Backlit 9in1
p. 172

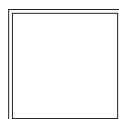

Surface Mounted
Luminaire Disc
p. 182

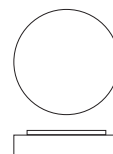

Damp-Proof Luminaire
Tricolor
p. 192



Downlight 68 Diled – 6 W Square
p. 164



Recessed Panel
Fled Backlit
p. 174

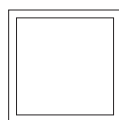

Surface Mounted
Luminaire Shine
p. 184

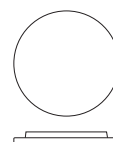

Damp-Proof Luminaire
Tricolor Emergency
p. 194



Downlight 60 Diled

The Downlight 60 Diled has a compact design, an ultra-shallow mounting depth and can be directly connected to 230 V – thanks to its 26 mm mounting depth it's perfect for use in furniture. Visually, it is hard to distinguish it from a halogen lamp. Thanks to the reflector, the light is completely glare-free. Highest color rendering (Ra 95), Dim-To-Warm technology and a long lifespan are further benefits.



Very good color rendering, Ra 95
 Integrated driver
 Also in Dim-To-Warm
 Die-cast aluminum
 Enhanced thermal management

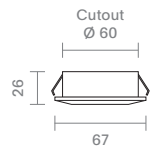

Downlight 60 Diled 5 W

Ultra-flat module for integration in furniture,
 only 26 mm mounting depth



Dimmable	Dim-To-Warm	Ra 95	IP20	50.000 hrs L80/B10	3 Years**	M/M
----------	-------------	-------	------	-----------------------	--------------	-----



	Product Code	Color	Wattage	Watt Equiv.	Voltage	Color Temp.	Luminous Flux	CRI	Dimmable	Angle	EEL	RRP*
1	5723001	white	5 W	40 W	230 V AC	2.700-2.100 K	300 lm	95	yes	36°		29,41 €
1	5723201	white	5 W	40 W	230 V AC	3.000 K	330 lm	95	yes	36°		26,89 €
2	5723501	steel	5 W	40 W	230 V AC	2.700-2.100 K	300 lm	95	yes	36°		29,41 €
2	5723701	steel	5 W	40 W	230 V AC	3.000 K	330 lm	95	yes	36°		26,89 €
3	5722101	black	5 W	40 W	230 V AC	2.700-2.100 K	300 lm	95	yes	36°		29,41 €
3	5722001	black	5 W	40 W	230 V AC	3.000 K	330 lm	95	yes	36°		26,89 €

This lamp contains built-in LED bulbs. The bulbs inside the lamp cannot be changed.
 ** Consumer warranty only. Warranty conditions on page 258.

Downlight 68 Diled – 6 W

With its 32 mm mounting depth, the Downlight 68 Diled – 6 W is extremely flat. No matter, if office or private home: With its wide range of color options, the Downlight blends in harmonically with its surroundings. Like all Diled Series Downlights, the compact module looks like a halogen lamp. Other advantages include glare-free light thanks to the reflector, maximum color rendering (Ra 95), Dim-To-Warm technology, a long lifespan, and direct connection to 230 V.

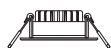

Very good color rendering, Ra 95
 Ultra-shallow mounting depth
 Integrated driver
 Also in Dim-To-Warm
 Die-cast aluminum
 Enhanced thermal management

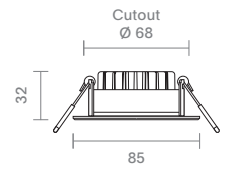

Downlight 68 Diled – 6 W

Flat module with only 32 mm mounting depth
 Can be swiveled up to 25°

Dimmable 	Dim-To-Warm 	Ra 95 	IP20	50.000 hrs L80/B10	3 Years**
--------------	-----------------	-----------	------	-----------------------	--------------



	Product Code	Color	Wattage	Watt Equiv.	Voltage	Color Temp.	Luminous Flux	CRI	Dimmable	Angle	EEL	RRP*
1	5724001	white	6 W	60 W	230 V AC	2.700–2.100 K	360 lm	95	yes	36°		39,50 €
1	5724101	white	6 W	60 W	230 V AC	2.700 K	370 lm	95	yes	36°		36,13 €
1	5724201	white	6 W	60 W	230 V AC	3.000 K	380 lm	95	yes	36°		36,13 €
2	5724501	steel	6 W	60 W	230 V AC	2.700–2.100 K	360 lm	95	yes	36°		39,50 €
2	5724601	steel	6 W	60 W	230 V AC	2.700 K	370 lm	95	yes	36°		36,13 €
2	5724701	steel	6 W	60 W	230 V AC	3.000 K	380 lm	95	yes	36°		36,13 €
3	5725501	black	6 W	60 W	230 V AC	2.700–2.100 K	360 lm	95	yes	36°		39,50 €
3	5725601	black	6 W	60 W	230 V AC	3.000 K	380 lm	95	yes	36°		36,13 €
4	5725701	black-chrome	6 W	60 W	230 V AC	2.700–2.100 K	360 lm	95	yes	36°		39,50 €
4	5725801	black-chrome	6 W	60 W	230 V AC	3.000 K	380 lm	95	yes	36°		36,13 €
5	5727001	champagne	6 W	60 W	230 V AC	2.700–2.100 K	360 lm	95	yes	36°		39,50 €
5	5727201	champagne	6 W	60 W	230 V AC	3.000 K	380 lm	95	yes	36°		36,13 €
6	5727501	anthracite	6 W	60 W	230 V AC	2.700–2.100 K	360 lm	95	yes	36°		39,50 €
6	5727701	anthracite	6 W	60 W	230 V AC	3.000 K	380 lm	95	yes	36°		36,13 €

This lamp contains built-in LED bulbs. The bulbs inside the lamp cannot be changed.
 ** Consumer warranty only. Warranty conditions on page 258.

Downlight 68 Diled Low Glare

The Downlight 68 Diled Low Glare – 6 W features a recessed LED module that provides soft, glare-free illumination and blends seamlessly into the ceiling surface. With outstanding color rendering (Ra 95), it combines the classic look of a halogen lamp with the technological advantages of today's lighting technology. It offers a sophisticated option for work and living areas.



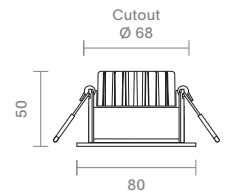

Very good color rendering, Ra 95
 Integrated driver
 Die-cast aluminum
 Deeper light output to reduce glare



Downlight 68 Diled Low Glare



		40.000 hrs <small>L80/B10</small>	3 <small>Years**</small>
---	---	---	------------------------------------

Product Code	Color	Wattage	Watt Equiv.	Voltage	Color Temp.	Luminous Flux	CRI	Dimmable	Angle	EEI	RRP*
5727801	white	6 W	50 W	230 V AC	2.700 K	340 lm	95	yes	32°		26,89 €
5727901	white	6 W	50 W	230 V AC	3.000 K	350 lm	95	yes	32°		26,89 €

This lamp contains built-in LED bulbs. The bulbs inside the lamp cannot be changed.
 ** Consumer warranty only. Warranty conditions on page 258.

Downlight 68 Diled – 10 W

The Downlight 68 Diled – 10 W provides up to 730 lm, making it remarkably bright. To direct the light where it is needed, the downlight can be swiveled up to 25°. As usual with the Diled series, the light is glare-free thanks to reflection via the reflector. The look of a halogen lamp, its compact design, highest color rendering (Ra 95), Dim-To-Warm technology, a long lifespan, and direct connection to 230 V complete the list of advantages.



Very good color rendering, Ra 95
 Integrated driver
 Also in Dim-To-Warm
 Die-cast aluminum
 Enhanced thermal management

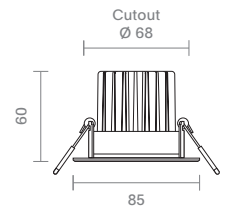

Downlight 68 Diled – 10 W
 Bright downlight with up to 730 lm
 Can be swiveled up to 25°



Dimmable 	Dim-To-Warm 	Ra 95 	IP20	50.000 hrs L80/B10	3 Years**
--------------	-----------------	-----------	------	-----------------------	--------------

	Product Code	Color	Wattage	Watt Equiv.	Voltage	Color Temp.	Luminous Flux	CRI	Dimmable	Angle	EEI	RRP*
1	5726001	white	10 W	90 W	230 V AC	2.700–2.100 K	610 lm	95	yes	36°		46,22 €
1	5726101	white	10 W	90 W	230 V AC	2.700 K	640 lm	95	yes	36°		39,50 €
1	5726201	white	10 W	90 W	230 V AC	3.000 K	640 lm	95	yes	36°		39,50 €
1	5726301	white	10 W	90 W	230 V AC	4.000 K	730 lm	95	yes	36°		39,50 €
2	5726501	steel	10 W	90 W	230 V AC	2.700–2.100 K	610 lm	95	yes	36°		46,22 €
2	5726601	steel	10 W	90 W	230 V AC	2.700 K	640 lm	95	yes	36°		39,50 €
2	5726701	steel	10 W	90 W	230 V AC	3.000 K	640 lm	95	yes	36°		39,50 €
2	5726801	steel	10 W	100 W	230 V AC	4.000 K	730 lm	95	yes	36°		39,50 €

This lamp contains built-in LED bulbs. The bulbs inside the lamp cannot be changed.
 ** Consumer warranty only. Warranty conditions on page 258.

Downlight 68 Diled – 6 W Square

The Downlight 68 Diled – 6 W in its square version impresses with a striking design and a shallow mounting depth of only 32 mm. As part of the Diled series, the downlight retains the familiar appearance of a halogen lamp, but offers the advantages of modern lighting technology.

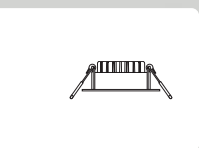
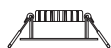

Very good color rendering, Ra 95
 Distinctive, angular design
 Integrated driver
 Also in Dim-To-Warm
 Die-cast aluminum
 Enhanced thermal management

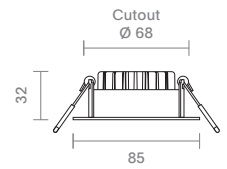

Downlight 68 Diled – 6 W Square
 Flat module with only 32 mm mounting depth
 Can be swiveled up to 25°

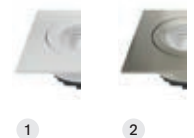

Dimmable 	Ra 95 	IP20	50.000 hrs L80/B10	3 Years**
--------------	-----------	------	-----------------------	--------------

	Product Code	Color	Wattage	Watt Equiv.	Voltage	Color Temp.	Luminous Flux	CRI	Dimmable	Angle	EEI	RRP*
1	5734101	white	6 W	60 W	230 V AC	2.700 K	370 lm	95	yes	36°		36,13 €
1	5734201	white	6 W	60 W	230 V AC	3.000 K	380 lm	95	yes	36°		36,13 €
2	5734401	steel	6 W	60 W	230 V AC	2.700 K	370 lm	95	yes	36°		36,13 €
2	5734501	steel	6 W	60 W	230 V AC	3.000 K	380 lm	95	yes	36°		36,13 €

This lamp contains built-in LED bulbs. The bulbs inside the lamp cannot be changed.
 ** Consumer warranty only. Warranty conditions on page 258.

Downlight IP54 Argent

Recessed downlight with IP54 rating that can be swiveled into all directions. For use in areas exposed to moisture and isolated ceilings.

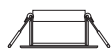

High color rendering, Ra 90
 IP rating, front: IP54
 Max. tilt 30°; 360° swiveling
 Visually pleasant 36° reflector
 Can be installed in insulation up to the insulation layer
 Ceiling cutout: 68–83 mm
 Can also be controlled with Casambi

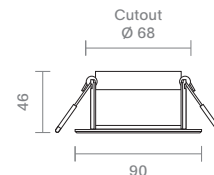

Mounting version without adapter ring

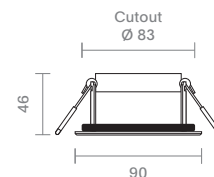

Mounting version with adapter ring

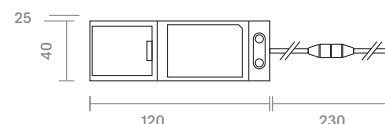

Image on the left: Includes adapter ring and external, dimmable driver with plug connection, connection cable: 230 mm
 120 x 40 x 25 mm (L x W x H)
 Image on the right: Installation in insulation



Downlight IP54 Argent

Includes adapter ring for various ceiling cutouts



Dimmable 	Dim-To-Warm 	Ra 90 	IP54	50.000 hrs L70/B10	3 Years**	
---------------------	------------------------	------------------	-------------	------------------------------	---------------------	--

Product Code	Color	Wattage	Watt Equiv.	Voltage	Color Temp.	Luminous Flux	CRI	Dimmable	Angle	EEI	RRP*
Casambi, dimmable											
1 5711401	white	8 W	40 W	230 V AC	3.000 K	580 lm	90	Casambi	36°		167,23 €
TRIAC, dimmable											
1 5711201	white	8 W	30 W	230 V AC	3.000–2.000 K	450 lm	90	yes	36°		57,98 €
1 5711301	white	8 W	40 W	230 V AC	3.000 K	580 lm	90	yes	36°		55,46 €
2 5711501 New	black	8 W	30 W	230 V AC	3.000–2.000 K	450 lm	90	yes	36°		57,98 €
2 5711601 New	black	8 W	40 W	230 V AC	3.000 K	580 lm	90	yes	36°		55,46 €

This lamp contains built-in LED bulbs. The bulbs inside the lamp cannot be changed.
 ** Consumer warranty only. Warranty conditions on page 258.

Downlight Fled

Mounted or recessed luminaire –
3-CCT surface
Standard refurbishment luminaires
with variable mounting system in
three sizes (75 W, 100 W and
200 W replacement)

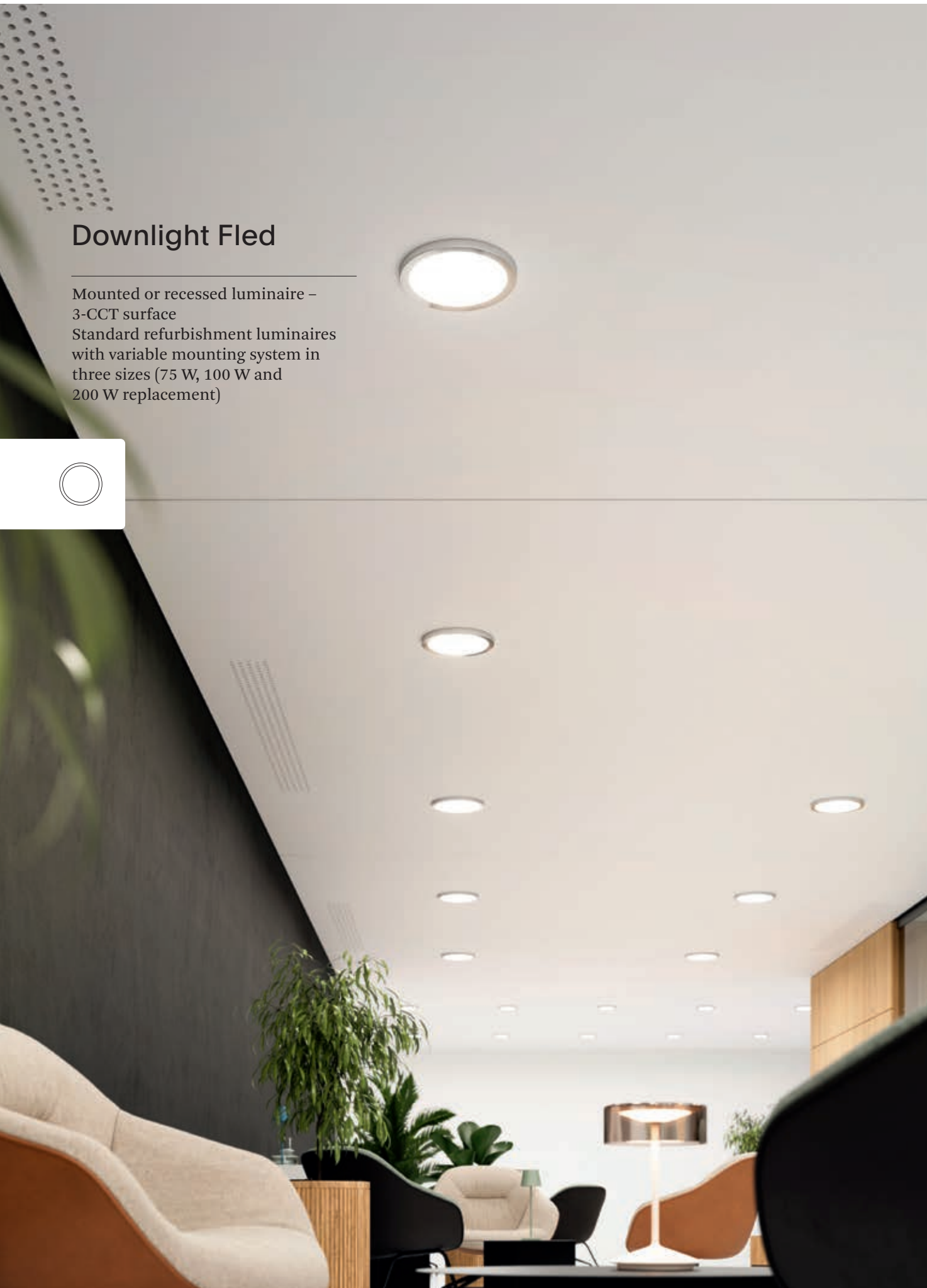

Easy-snap system to magnetically mount additional decor rings
 Can be surface mounted or recessed into existing drill holes
 (65–310 mm) using the adjustable spring mount
 DIP switch to tune color temperatures: 3.000 K, 4.000 K, and 5.000 K
 Only 19 mm high
 Driver integrated in casing
 Flicker-free
 Ra 90



1

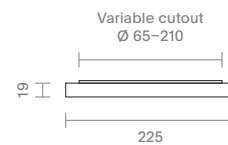

2

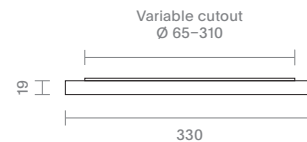

3

Easy installation using the adjustable spring mount



Downlight Fled

3-CCT surface mounted or recessed luminaire



Ra 90	IP20	25.000 hrs L70/B10	3 Years**
-------	------	-----------------------	--------------

	Product Code	Color	Wattage	Watt Equiv.	Voltage	Color Temp.	Luminous Flux	CRI	Dimmable	Angle	EEL	RRP*
1	5795201	white	12 W	75 W	230 V AC	5.000/4.000/3.000 K	1.050 lm	90	no	120°		24,37 €
2	5795401	white	18 W	100 W	230 V AC	5.000/4.000/3.000 K	1.800 lm	90	no	120°		32,77 €
3	5795601	white	30 W	200 W	230 V AC	5.000/4.000/3.000 K	3.100 lm	90	no	120°		57,98 €

Accessories

Fled decor rings for Fled 3-CCT surface mounted or recessed luminaire
 Magnetically mounted to the luminaire using the easy-snap system
 Color options Chrome and Nickel

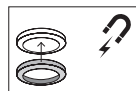

	Product Code	Diameter	Suitable for product	RRP*
4	Decor ring, chrome			
	5796001	170 mm	5795201	11,76 €
	5796101	225 mm	5795401	12,61 €
	5796201	330 mm	5795601	15,97 €
5	Decor ring, nickel			
	5796301	170 mm	5795201	11,76 €
	5796401	225 mm	5795401	12,61 €
	5796501	330 mm	5795601	15,97 €

4



5



This lamp contains built-in LED bulbs. The bulbs inside the lamp cannot be changed.
 ** Consumer warranty only. Warranty conditions on page 258.

Downlight Fled Slim

Flat downlights with a shallow mounting depth and integrated driver and narrow frame for 100–110 mm, 150–160 mm, and 200–210 mm drill hole diameters.



High color rendering: Ra 90
 Three different sizes
 DIP switch to tune color temperatures: 3.000 K, 4.000 K, and 5.000 K
 Only 32 mm high, driver integrated in casing
 Flicker-free
 Ideal for replacing pot lights with compact fluorescent lamps

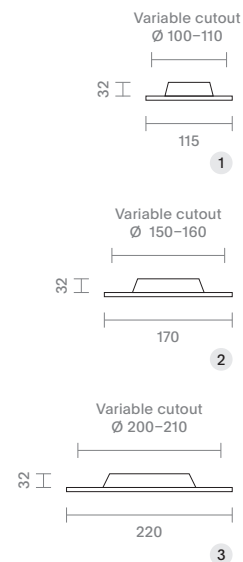

Downlight Fled Slim

Flat downlights with shallow mounting depth



Ra 90 	IP20	25.000 hrs L70/B10	3 Years**
-----------	------	-----------------------	--------------

	Product Code	Color	Wattage	Watt Equiv.	Voltage	Color Temp.	Luminous Flux	CRI	Dimmable	Angle	EEL	RRP*
1	4070101	white	6 W	50 W	230 V AC	5.000/4.000/3.000 K	310 lm	90	no	120°		10,92 €
2	4070201	white	12 W	75 W	230 V AC	5.000/4.000/3.000 K	740 lm	90	no	120°		15,97 €
3	4070301	white	18 W	120 W	230 V AC	5.000/4.000/3.000 K	1.300 lm	90	no	120°		23,53 €

This lamp contains built-in LED bulbs. The bulbs inside the lamp cannot be changed.
 ** Consumer warranty only. Warranty conditions on page 258.

New.

Recessed Panel Fled Backlit 9in 1

The 9in1 Recessed Backlit Fled Panel impresses with maximum flexibility. The three output levels and three color temperatures can be set directly on the driver – allowing quick adjustment for any and all applications. With an efficiency of 150 lm/W and a lifespan of 50.000 hrs (L80/B10) the panel is extremely sustainable and subsidy-friendly. The UGR value of <19 makes it perfect for use in office workspaces.

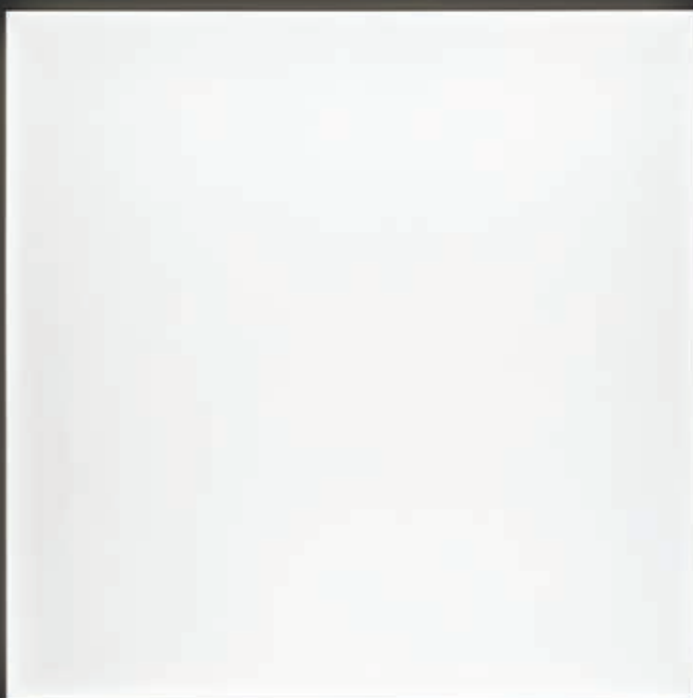

The three output levels and three color temperatures can be set directly on the driver
 For standard-conform lighting in offices with screen workplaces according to DIN EN 12464-1
 Up to 150 lm/W

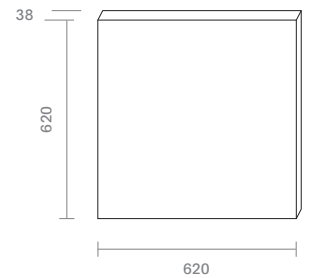

Frameless design



Output levels and color temperatures can be set directly on the driver

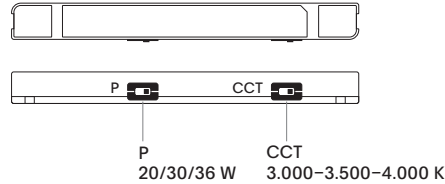

New. Recessed Panel Fled Backlit 9in1
 Includes adjustable ENEC-certified driver
 for adjusting light color and output



IP20	50.000 hrs L80/B10	5 Years**
------	-----------------------	--------------

Product Code	Dimensions (L x W x H)	Color	Wattage	Input	Color Temp.	Luminous Flux	CRI	Dimmable	Angle	EEL	RRP*
4044801	620 x 620 x 38 mm	white	36-20 W	40 V DC/900 mA	4.000/3.500/3.000 K	5.400-2.750 lm	80	no	84°		79,83 €

This lamp contains built-in LED bulbs. The bulbs inside the lamp cannot be changed.
 ** Consumer warranty only. Warranty conditions on page 258.

Recessed Panel Fled Backlit

With its individual driver selection, our Recessed Panel Fled Backlit with its mounting depth of only 25 mm offers a wide variety of applications. TRIAC, DALI, or Casambi – when it comes to dimming, no wish remains unfulfilled. With its UGR value of <math><19</math> it is perfect for office workspaces. With a lifespan of 50.000 hrs (L80/B10) and 120 lm/W, the panel is subsidy-friendly.



For standard-conform lighting in offices with screen workplaces according to DIN EN 12464-1
 Highly efficient with up to 120 lm/W
 Environmentally friendly packaging
 Individual choice of driver

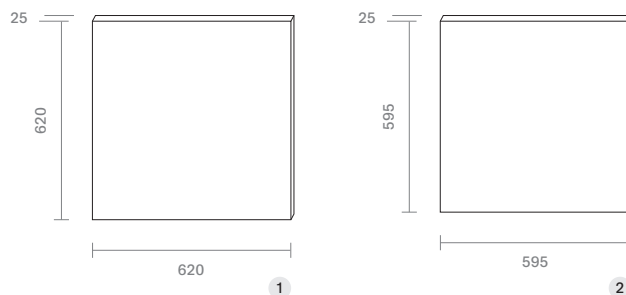

Recessed Panel Fled Backlit UGR<19

For use with constant current drivers

Dimmable 	IP40	50.000 hrs L80/B10	5 Years**
--------------	------	-----------------------	--------------



Product Code	Dimensions (L x W x H)	Color	Wattage	Input	Color Temp.	Luminous Flux	CRI	Dimmable	Angle	EEI	RRP*
100 lm/W											
1 4044001	620 x 620 x 25 mm	white	36 W	40 V DC/900 mA	4.000 K	3.600 lm	80	yes	90°		36,13 €
Color switch											
1 4044401	620 x 620 x 25 mm	white	36 W	40 V DC/900 mA	5.700/4.000/3.000 K	3.500 lm	80	yes	90°		43,70 €
120 lm/W											
1 4044201	620 x 620 x 25 mm	white	36 W	40 V DC/900 mA	4.000 K	4.400 lm	80	yes	90°		39,50 €
2 4044601 New	595 x 595 x 25 mm	white	36 W	40 V DC/900 mA	4.000 K	4.400 lm	80	yes	90°		39,50 €

Powerline Constant Current Driver

Product Code	Wattage	Input voltage	Output	L x W x H (mm)	t _c max.	t _a max.	IP	Dimmable	RRP*
Powerline Constant Current Driver Philips ENEC-certified, flicker-free									
9205102	36 W	240–200 V AC	40–30 V DC/900 mA	118 x 42 x 28	65 °C	40 °C	IP20	no	10,08 €
Powerline Constant Current Driver, DIP 1.000–500 mA adjustable, flicker-free									
9205601	20–40 W	240–200 V AC	40–30 V DC/1.000–500 mA	138 x 47 x 30	85 °C	45 °C	IP20	no	11,76 €
Powerline Constant Current Driver TRIAC Primarily dimmable using forward or reverse phase dimmers, TÜV certified, flicker-free									
9205201	36 W	240–200 V AC	40–30 V DC/850 mA	138 x 47 x 30	90 °C	45 °C	IP20	yes	26,05 €
Powerline Constant Current Driver DALI TÜV and ENEC-certified, flicker-free, 1.000–450 mA adjustable									
9205323	22–47,3 W	240–200 V AC	42–6 V DC/1.100–450 mA	103 x 68,5 x 31	90 °C	45 °C	IP20	yes	39,50 €
9205723 New	25–40 W	240–200 V AC	42–24 V DC/1.050–600 mA	137 x 46 x 30	90 °C	45 °C	IP20	yes	29,41 €
Powerline Constant Current Driver Casambi TÜV-certified									
9205401	36 W	240–200 V AC	40–28 V DC/850 mA	138 x 47 x 30	90 °C	45 °C	IP20	yes	100,00 €

Surface Mounting Frame

Plug-in system with metal connectors

Product Code	Dimensions (L x W x H)	Color	RRP*
4044901	624 x 624 x 65 mm	white	20,17 €



This lamp contains built-in LED bulbs. The bulbs inside the lamp cannot be changed.
 ** Consumer warranty only. Warranty conditions on page 258.

Surface Mounted Panel Fled square

The Surface Mounted Panel Fled has a pre-installed frame and is easy to install thanks to its quick-mount system. With a height of only 28 mm and a driver that is integrated in the frame, it looks almost exactly like a recessed panel.



Surface mounted panel with pre-installed frame
 Only 28 mm high when mounted
 Includes driver (integrated into the frame)
 Quick mount system
 Highly efficient with up to 120 lm/W

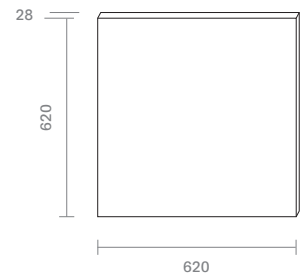

Easy mounting with driver
 integrated into the frame



Surface Mounted Panel Fled 100 lm/W



IP20	25.000 hrs L70/B10	3 Years**
-------------	------------------------------	---------------------

Product Code	Dimensions (L x W x H)	Color	Wattage	Voltage	Color Temp.	Luminous Flux	CRI	Dimmable	Angle	EEL	RRP*
UGR<22											
4040701	620 x 620 x 28 mm	white	36 W	42-30 V DC	3.000 K	3.600 lm	80	no	120°		100,00 €
4040801	620 x 620 x 28 mm	white	36 W	42-30 V DC	4.000 K	3.600 lm	80	no	120°		100,00 €
UGR<19											
4041701	620 x 620 x 28 mm	white	36 W	42-30 V DC	3.000 K	3.600 lm	80	no	95°		108,40 €
4041801	620 x 620 x 28 mm	white	36 W	42-30 V DC	4.000 K	3.600 lm	80	no	95°		108,40 €

Surface Mounted Panel Fled 120 lm/W



IP20	50.000 hrs L80/B10	5 Years**
-------------	------------------------------	---------------------

Product Code	Dimensions (L x W x H)	Color	Wattage	Voltage	Color Temp.	Luminous Flux	CRI	Dimmable	Angle	EEL	RRP*
UGR<22											
4042001	620 x 620 x 28 mm	white	36 W	42-30 V DC	3.000 K	4.320 lm	80	no	120°		108,40 €
4042101	620 x 620 x 28 mm	white	36 W	42-30 V DC	4.000 K	4.320 lm	80	no	120°		108,40 €
UGR<19											
4042201	620 x 620 x 28 mm	white	36 W	42-30 V DC	3.000 K	4.320 lm	80	no	95°		116,81 €
4042301	620 x 620 x 28 mm	white	36 W	42-30 V DC	4.000 K	4.320 lm	80	no	95°		116,81 €

This lamp contains built-in LED bulbs. The bulbs inside the lamp cannot be changed.
 ** Consumer warranty only. Warranty conditions on page 258.

Surface Mounted Panel Fled rectangular

The Surface Mounted Panel Fled has a pre-installed frame and is easy to install thanks to its quick-mount system. With a height of only 28 mm and a driver that is integrated in the frame, it looks almost exactly like a recessed panel.

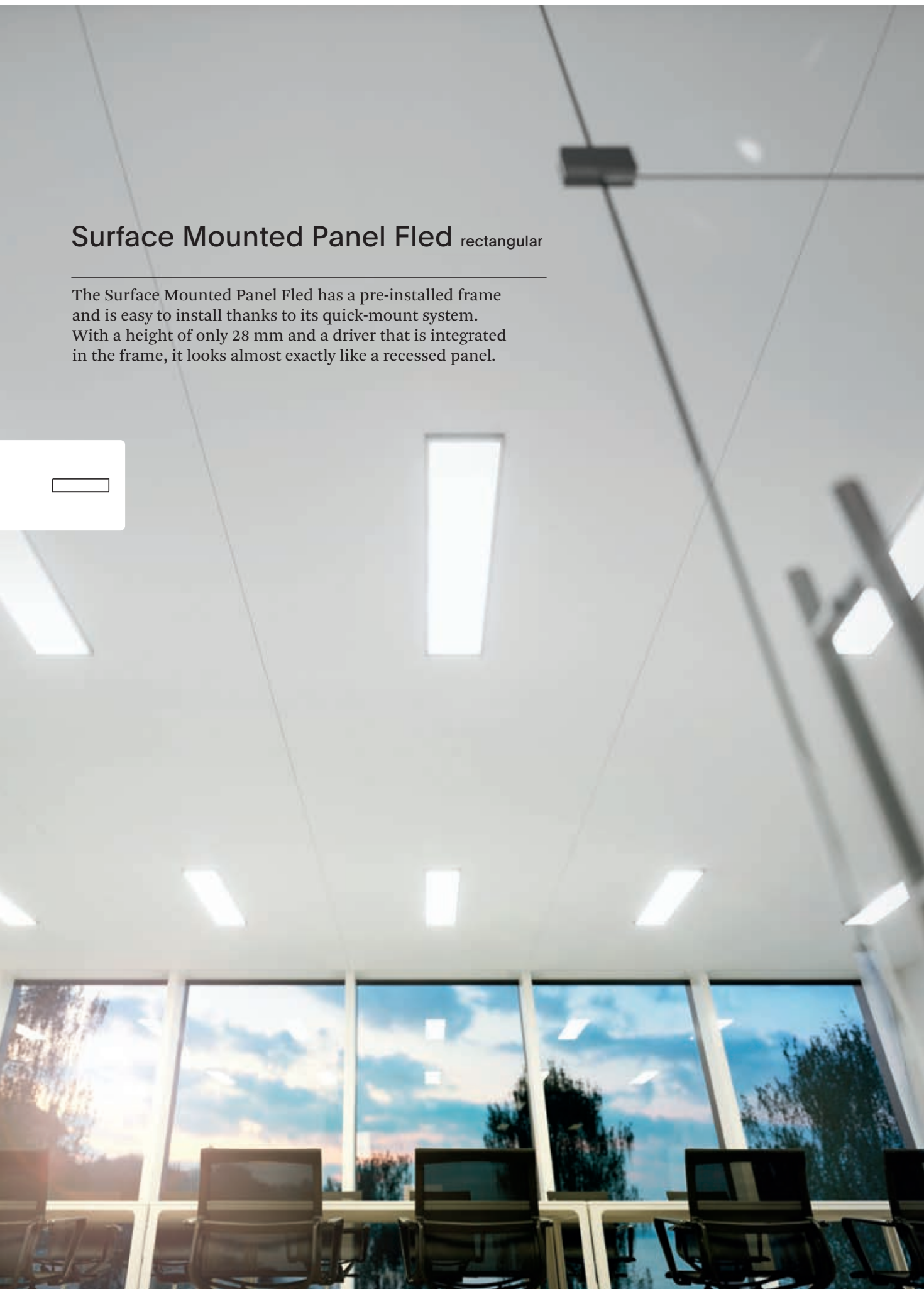

Surface mounted panel with pre-installed frame
 Only 28 mm high when mounted
 Includes driver (integrated into the frame)
 Quick mount system
 Highly efficient with up to 120 lm/W

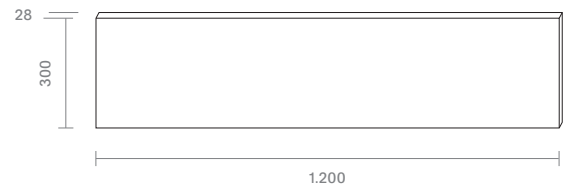

Easy mounting with driver
 integrated into the frame



Surface Mounted Panel Fled 100 lm/W



IP20	25.000 hrs L70/B10	3 Years**
-------------	------------------------------	---------------------

Product Code	Dimensions (L x W x H)	Color	Wattage	Voltage	Color Temp.	Luminous Flux	CRI	Dimmable	Angle	EEL	RRP*
UGR<22											
4040901	1.200 x 300 x 28 mm	white	36 W	42-30 V DC	3.000 K	3.600 lm	80	no	120°		115,97 €
4041001	1.200 x 300 x 28 mm	white	36 W	42-30 V DC	4.000 K	3.600 lm	80	no	120°		115,97 €
UGR<19											
4041501	1.200 x 300 x 28 mm	white	36 W	42-30 V DC	3.000 K	3.600 lm	80	no	95°		129,41 €
4041601	1.200 x 300 x 28 mm	white	36 W	42-30 V DC	4.000 K	3.600 lm	80	no	95°		129,41 €

Surface Mounted Panel Fled 120 lm/W



IP20	50.000 hrs L80/B10	5 Years**
-------------	------------------------------	---------------------

Product Code	Dimensions (L x W x H)	Color	Wattage	Voltage	Color Temp.	Luminous Flux	CRI	Dimmable	Angle	EEL	RRP*
UGR<22											
4043001	1.200 x 300 x 28 mm	white	36 W	42-30 V DC	3.000 K	4.320 lm	80	no	120°		129,41 €
4043101	1.200 x 300 x 28 mm	white	36 W	42-30 V DC	4.000 K	4.320 lm	80	no	120°		129,41 €
UGR<19											
4043201	1.200 x 300 x 28 mm	white	36 W	42-30 V DC	3.000 K	4.320 lm	80	no	95°		139,50 €
4043301	1.200 x 300 x 28 mm	white	36 W	42-30 V DC	4.000 K	4.320 lm	80	no	95°		139,50 €

This lamp contains built-in LED bulbs. The bulbs inside the lamp cannot be changed.
 ** Consumer warranty only. Warranty conditions on page 258.

Surface Mounted Luminaire Plank

The Surface Mounted Luminaire Plank stands out with a straight, plank-like design and high-quality materials. With its three available lengths, it is the perfect replacement for diffuser luminaires with 18, 36, or 58 Watt fluorescent lamps. Other benefits: The base plate can be dismantled, making it especially easy to mount. With the variable output levels and color temperature choices, it's the perfect all-round luminaire.



Shadow-free illumination
 Three lengths up to 1.500 mm
 As replacement for classic diffuser luminaires
 DIP switch to set 3.000 K or 4.000 K
 The base plate can be dismantled, making it especially easy to mount
 Up to three output levels, adjustable via DIP switch
 Connection cables can be attached from the side or the center
 Feed-through wiring
 IP: IP54
 Impact protection: IK10

Optional pendant set

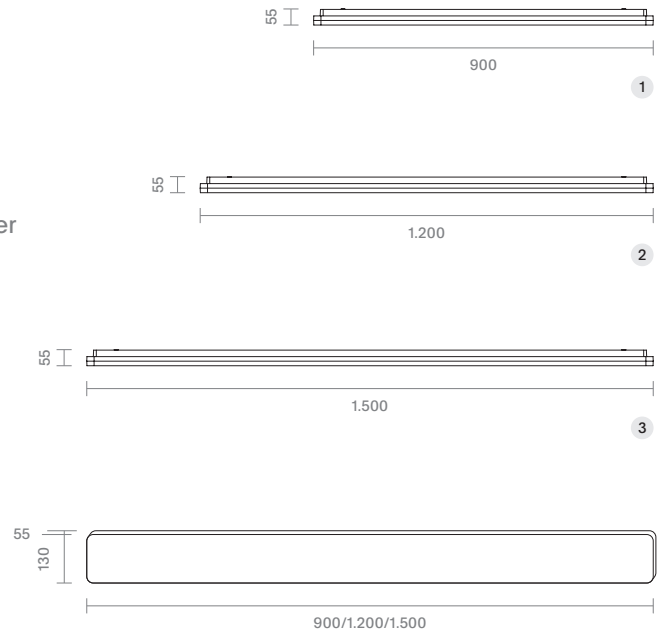
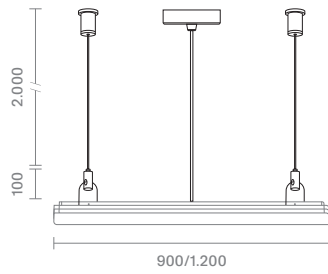

Surface Mounted Luminaire Plank



Dimmable 	IP54	50.000 hrs L80/B10	5 Years**
--------------	------	-----------------------	--------------

	Product Code	Dimensions (L x W x H)	Color	Wattage	Voltage	Color Temp.	Luminous Flux	CRI	Dimmable	Angle	EEL	EEI	RRP*
1	4036001	900 x 130 x 55 mm	silver	32/24 W	230 V AC	4.000/3.000 K	3.500/2.700 lm	80	yes	120°			167,23 €
2	4036101	1.200 x 130 x 55 mm	silver	38/29 W	230 V AC	4.000/3.000 K	4.200/3.200 lm	80	yes	120°			209,24 €
3	4036201	1.500 x 130 x 55 mm	silver	50/40/30 W	230 V AC	4.000/3.000 K	5.800/4.500/3.500 lm	80	yes	120°			268,07 €
	4039001	Pendant Set											24,37 €

This lamp contains built-in LED bulbs. The bulbs inside the lamp cannot be changed.
 ** Consumer warranty only. Warranty conditions on page 258.

Surface Mounted Luminaire Disc

Minimalist design with a wide variety of options.

Versatile power supply options, adjustable output levels and color temperatures, as well as optional indirect lighting simplify stockkeeping and offer a wide range of possible applications. The luminaire body made of high-quality aluminum guarantees stability and a long lifespan. The micro-prismatic diffuser guarantees optimal light distribution and reduces glare.



Suitable for feed-through wiring by design
 Easy mounting – connection cables can be attached from the side or the center
 DIP switch to tune luminous flux and color temperatures
 Impact protection: IK07

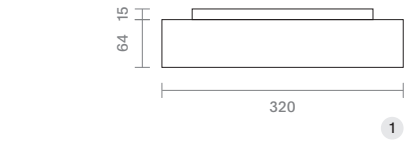

Two light scenes: Upward or downward lumination, or lumination up and down for additional indirect lighting



Surface Mounted Luminaire Disc UGR<19



Dimmable	Ra90	IP20	3 SDCM	50.000 hrs L80/B10	5 Years**
----------	------	------	-----------	-----------------------	--------------

	Product Code	Dimensions (diameter x H)	Color	Wattage	Voltage	Color Temp.	Luminous Flux	CRI	Dimmable	Angle	EEI	RRP*
1	4027401	320 x 64/79 mm	black	24/18/10 W	230 V AC	4.000/3.000 K	2.100/1.600/920 lm	90	yes	90°		189,08 €
1	4027501	320 x 64/79 mm	white	24/18/10 W	230 V AC	4.000/3.000 K	2.100/1.600/920 lm	90	yes	90°		189,08 €
2	4027601	450 x 64/79 mm	black	30/22/17 W	230 V AC	4.000/3.000 K	3.100/2.300/1.800 lm	90	yes	90°		310,08 €
2	4027701	450 x 64/79 mm	white	30/22/17 W	230 V AC	4.000/3.000 K	3.100/2.300/1.800 lm	90	yes	90°		310,08 €
3	4027801	600 x 64/79 mm	black	55/38 W	230 V AC	4.000/3.000 K	5.500/4.000 lm	90	yes	90°		441,18 €
3	4027901	600 x 64/79 mm	white	55/38 W	230 V AC	4.000/3.000 K	5.500/4.000 lm	90	yes	90°		441,18 €

This lamp contains built-in LED bulbs. The bulbs inside the lamp cannot be changed.
 ** Consumer warranty only. Warranty conditions on page 258.

Surface Mounted Luminaire Shine

Purist luminaire with evenly distributed light across its surface, ultra-flat design, ambient light on the back, and flexible wiring options. Output levels and color temperatures can be selected, minimizing stockkeeping and maximizing possible applications.



Bright, surface-mounted luminaire with ambient lighting on the back
 Tool-free installation of the luminaire on the base plate
 Integrated connector for feed-through wiring
 Connection cables can be attached from the side or the center
 DIP switch to tune luminous flux and color temperatures
 Impact protection: IK08

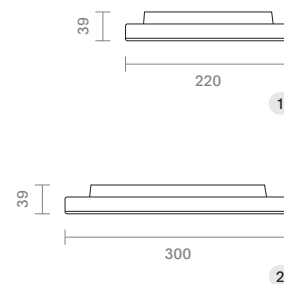

Tool-free installation of the luminaire on the base plate



Surface Mounted Luminaire Shine



Dimmable 	Ra 90 	IP20	50.000 hrs L80/B50	5 Years**
--------------	-----------	------	-----------------------	--------------

	Product Code	Dimensions (diameter x H)	Color	Wattage	Voltage	Color Temp.	Luminous Flux	CRI	Dimmable	Angle	EEI	RRP*
Dimmable												
1	4025601	220 x 39 mm	white	15/10/8 W	230 V AC	4.000/3.000 K	1.350/900/800 lm	90	yes	120°		108,40 €
2	4025701	300 x 39 mm	white	24/18/10 W	230 V AC	4.000/3.000 K	2.300/1.800/1.000 lm	90	yes	120°		158,82 €
DALI												
1	4025801	220 x 39 mm	white	15/10/8 W	230 V AC	4.000/3.000 K	1.350/900/800 lm	90	DALI	120°		125,21 €
2	4025901	300 x 39 mm	white	24/18/10 W	230 V AC	4.000/3.000 K	2.300/1.800/1.000 lm	90	DALI	120°		167,23 €

This lamp contains built-in LED bulbs. The bulbs inside the lamp cannot be changed.
 ** Consumer warranty only. Warranty conditions on page 258.

New.

Surface Mounted Luminaire Circel

Round ceiling luminaire in a timeless design with lateral light output. Adjustable output levels and color temperatures enable flexible usage with minimum stocks. Optionally available with a motion sensor. Thanks to the removable base plate, convenient and time-saving installation.



Shadow-free illumination
 Output and luminous flux can be conveniently adjusted at the base plate
 Three sizes with up to 400 mm diameter
 With the quick mount set, suitable as a project luminaire
 Adjustable motion sensor – radius and time (Product Code: 4231201)
 Frame color: silver
 Impact protection: IK08



Tool-free installation of the luminaire on the base plate



New. Surface Mounted Luminaire Circel



IP54	Sensor 	50.000 hrs L80/B10	5 Years**
-------------	-------------------	------------------------------	---------------------

	Product Code	Dimensions (diameter x H)	Color	Wattage	Voltage	Color Temp.	Luminous Flux	CRI	Dimmable	Angle	EEL	RRP*
1	4231001	220 x 50 mm	silver	15/10 W	230 V AC	4.000/3.000 K	1.700–1.200 lm	80	no	120°		79,83 €
2	4231101	270 x 50 mm	silver	22/16/10 W	230 V AC	4.000/3.000 K	2.800–1.200 lm	80	no	120°		133,61 €
3	4231301	400 x 65 mm	silver	28/22/18 W	230 V AC	4.000/3.000 K	3.600–2.400 lm	80	no	120°		167,23 €
	Motion Sensor											
2	4231201	270 x 50 mm	silver	22/16/10 W	230 V AC	4.000/3.000 K	2.800–1.200 lm	80	no	120°		184,03 €

This lamp contains built-in LED bulbs. The bulbs inside the lamp cannot be changed.
 ** Consumer warranty only. Warranty conditions on page 258.

New.

Surface Mounted Luminaire Square

This angular ceiling luminaire impresses with clean lines and modern lighting effect thanks to its lateral output. Output levels and color temperatures can be adjusted directly on the luminaire and enable flexible usage with minimum stocks. Optionally available with a motion sensor. The removable base plate facilitates a convenient and time-saving installation.

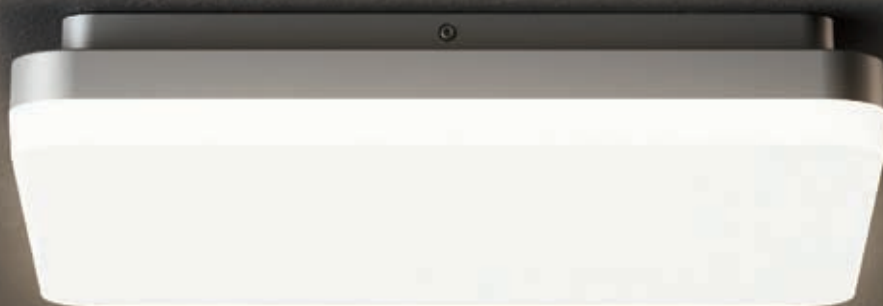
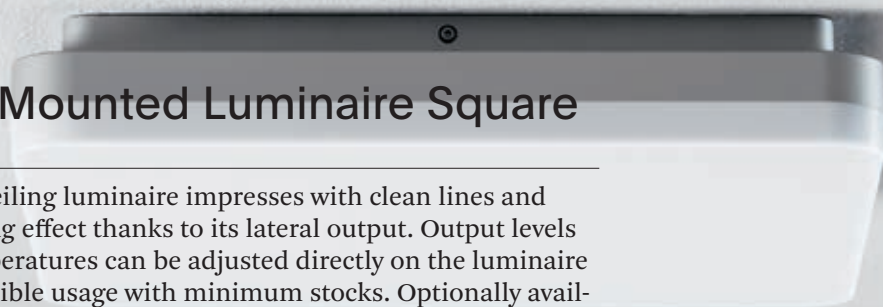

Shadow-free illumination

Output and luminous flux can be conveniently adjusted at the base plate

With the quick mount set, suitable as a project luminaire

Adjustable motion sensor – radius and time (Product Code: 4232201)

Frame color: silver

Impact protection: IK10

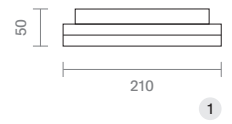

Tool-free installation of the luminaire on the base plate



New. Surface Mounted Luminaire Square



IP54	Sensor 	50.000 hrs L80/B10	5 Years**
-------------	-------------------	------------------------------	---------------------

	Product Code	Dimensions (L x W x H)	Color	Wattage	Voltage	Color Temp.	Luminous Flux	CRI	Dimmable	Angle	EEL	RRP*
1	4232001	210 x 210 x 50 mm	silver	15/10 W	230 V AC	4.000/3.000 K	1.700–1.200 lm	80	no	120°		79,83 €
2	4232101	260 x 260 x 53 mm	silver	22/16/10 W	230 V AC	4.000/3.000 K	2.800–1.200 lm	80	no	120°		133,61 €
3	4232301	400 x 400 x 67 mm	silver	28/22/18 W	230 V AC	4.000/3.000 K	3.600–2.400 lm	80	no	120°		167,23 €
	Motion Sensor											
2	4232201	260 x 260 x 53 mm	silver	22/16/10 W	230 V AC	4.000/3.000 K	2.800–1.200 lm	80	no	120°		184,03 €

This lamp contains built-in LED bulbs. The bulbs inside the lamp cannot be changed.

** Consumer warranty only. Warranty conditions on page 258.

New.

Surface Mounted Luminaire Moon

The round Surface Mounted Luminaire Moon combines functional lighting and simple design. The color temperature can be flexibly set using the DIP switch. A PMMA diffuser provides pleasant, flicker-free light. Available in three sizes at an attractive price, the Moon is ideally positioned for those on a tight budget.



DIP switch to tune color temperatures
 PMMA diffuser
 Flicker-free
 Impact protection: IK05

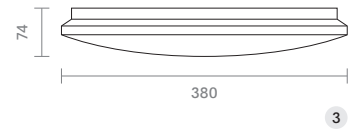
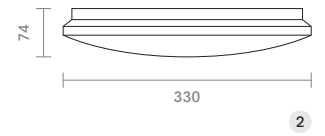
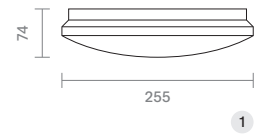

New. Surface Mounted Luminaire Moon



IP44	50.000 hrs L80/B10	3 Years**
-------------	------------------------------	---------------------

	Product Code	Dimensions (diameter x H)	Color	Wattage	Voltage	Color Temp.	Luminous Flux	CRI	Dimmable	Angle	EEL	RRP*
1	4029401	255 x 74 mm	white	12 W	230 V AC	5.700/4.000/3.000 K	1.310–1.180 lm	80	no	120°		22,69 €
2	4029501	330 x 74 mm	white	18 W	230 V AC	5.700/4.000/3.000 K	1.900–1.720 lm	80	no	120°		29,41 €
3	4029601	380 x 74 mm	white	24 W	230 V AC	5.700/4.000/3.000 K	2.540–2.300 lm	80	no	120°		36,13 €

This lamp contains built-in LED bulbs. The bulbs inside the lamp cannot be changed.
 ** Consumer warranty only. Warranty conditions on page 258.

Damp-Proof Luminaire Tricolor

Our Damp-Proof Luminaire Tricolor is the perfect solution for places that need robust and durable lighting. With a lifespan of 50.000 hrs (L80/B10) and pre-installed feed-through wiring, this luminaire offers a reliable, low-maintenance lighting option. The color temperature can be conveniently set with the DIP switch. The high impact protection (IK08) and the IP65 rating guarantee, that the luminaire survives in the rough environments.



DIP switch to tune color temperatures
 Includes feed-through wiring 3 × 1 mm²
 Robust polycarbonate casing IK08
 IP65 rating
 Stainless steel clips and mounting equipment included
 High light output: up to 120 lm/W
 Lifespan (L80/B10): up to 50.000 hrs
 Flicker-free
 Beam angle 120°

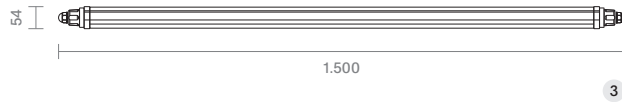
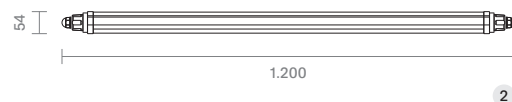
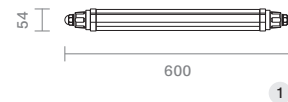

Pre-installed feed-through wiring



Damp-Proof Luminaire Tricolor



IP65	50.000 hrs L80/B10	3 Years**
-------------	------------------------------	---------------------

	Product Code	Dimensions (L x W x H)	Color	Wattage	Voltage	Color Temp.	Luminous Flux	CRI	Dimmable	Angle	EEL	Unit	RRP*
1	4029001	600 x 66 x 54 mm	grey	18 W	230 V AC	5.700/4.000/3.000 K	2.100 lm	80	no	120°		10	22,69 €
2	4029101	1.200 x 66 x 54 mm	grey	33 W	230 V AC	5.700/4.000/3.000 K	4.000 lm	80	no	120°		10	35,29 €
3	4029201	1.500 x 66 x 54 mm	grey	46 W	230 V AC	5.700/4.000/3.000 K	6.000 lm	80	no	120°		10	41,18 €

This lamp contains built-in LED bulbs. The bulbs inside the lamp cannot be changed.
 ** Consumer warranty only. Warranty conditions on page 258.

New.

Damp-Proof Luminaire Tricolor Emergency

As a single-battery luminaire, our Damp-Proof Luminaire Tricolor Emergency is the perfect choice for decentralized emergency lighting in harsh conditions. In addition to normal operation, the integrated emergency lighting set is suitable for continuous or standby operation. When connected to the normal power supply, luminous flux and color temperature can be freely selected via DIP switches. The status of the emergency light set is continuously shown on the luminaire. As certified emergency lighting with a service life of 50.000 hrs (L80/B10), this luminaire meets the highest requirements.



DIP switch to tune color temperatures and luminous flux
 Emergency light set with one battery
 Li-Ion rechargeable battery is replaceable
 Robust polycarbonate casing IK08
 IP65 rating
 Stainless steel clips and mounting equipment included
 High light output: up to 120 lm/W
 Lifespan (L80/B10): up to 50.000 hrs
 Flicker-free
 Beam angle 120°

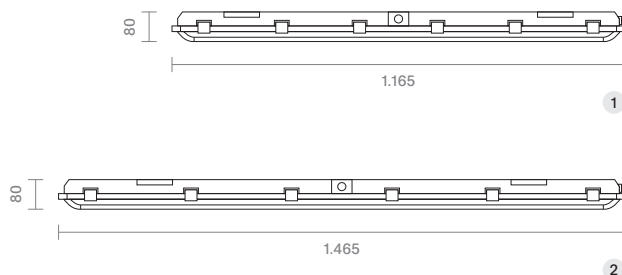

Includes emergency light set



Automated monthly and yearly self-test.
 This feature regularly monitors the luminaire state and runs tests to ensure that all components work properly. A status LED continuously informs about the state of the emergency light set. This includes battery, LED, driver and controller tests.

Data for Battery Operation

Input	3 W	Lifespan	up to 2.000 cycles
Input voltage	230 V AC	Runtime min.	3 hrs
Input frequency	50/60 Hz	Charging duration max.	24 hrs
Output	2 W	Switching duration	<1 sec
Input current	0,01 A	Ambient temperature	25-0 °C
Battery	6,4 V / 1.500 mAh / LiFePO4	Luminous flux emergency light 4029801	310 lm/3.000 K
Status Indicator	color LED	Luminous flux emergency light 4029901	270 lm/3.000 K

New. Damp-Proof Luminaire Tricolor Emergency

IP65	50.000 hrs L80/B10	3 Years**
------	-----------------------	--------------



	Product Code	Dimensions (L x W x H)	Color	Wattage	Voltage	Color Temp.	Luminous Flux	CRI	Dimmable	Angle	EEL	Unit	RRP*
1	4029801	1.165 x 75 x 80 mm	grey	40-25 W	230 V AC	5.700/4.000/3.000 K	4.720-3.020 lm	80	no	120°	10	10	142,02 €
2	4029901	1.465 x 75 x 80 mm	grey	50-28 W	230 V AC	5.700/4.000/3.000 K	6.050-3.950 lm	80	no	120°	10	10	158,82 €

This lamp contains built-in LED bulbs. The bulbs inside the lamp cannot be changed.
 ** Consumer warranty only. Warranty conditions on page 258.



Thala
—
Glowing
Composition
→ p. 200

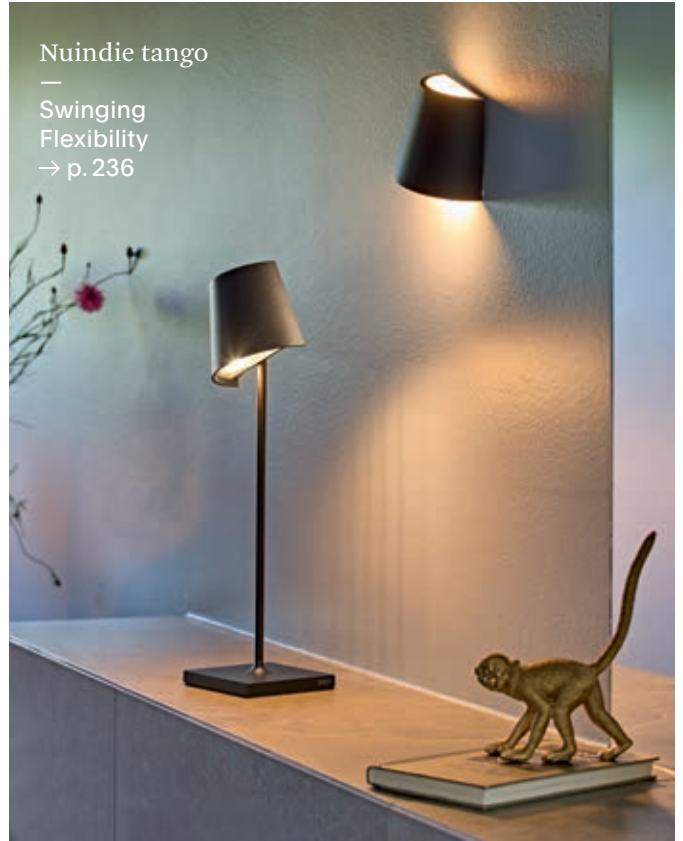

Nuindie tango
—
Swinging
Flexibility
→ p. 236



Numotion
—
Moving
Transparency
→ p. 232



Nutalis
—
Simple Beauty
→ p. 226



Nucandle
—
Whispering
Enlightenment
→ p. 204



Mahina
—
Light Show
of the Modern Era
→ p. 208

Battery Lights

Good light

Unique Design

Made of metal or glass

With rechargeable batteries

or charging station

Elegant or playful: Our battery-powered lights adapt perfectly to any environment thanks to the ever-growing selection of colors and materials. The unconventional designs and innovative additional features are real highlights that enhance any room.



Thala
p. 200



Nufflair
p. 216



Numotion
p. 232

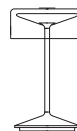

Accessories
p. 248



Nucandle
p. 204



Nudrop
p. 220



Nuindie tango
p. 236



Numove
p. 252



Mahina
p. 208

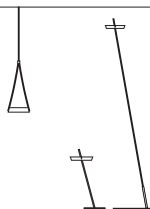

Nutalis
p. 226



Nuindie
p. 240

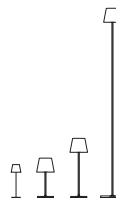

Nusolar
p. 254



A light like a gesture:
well balanced and timeless.

The ceramic-coated surface in ceramic-
white with a black shade impresses with
its simple elegance and pleasant feel.





New.

Thala

The Thala light combines three shapes to a complex sculpture. Base, body, and shade form a peaceful whole – minimalist and striking, like a design object. Their downward-facing light provides targeted brightness – ideal for tables, dressers, or bedside tables.



Downward lumination
 FlexMood Feature: 2.700 K + 2.200 K = warm white + warm white extra
 Dimming via touch feature on the lamp head
 Lighting time: up to 7 hrs
 Rechargeable Li-ion battery, 3.000 mAh
 IP65, suitable for outdoor use

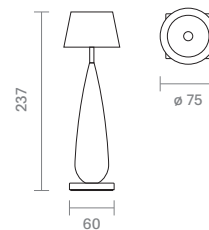

Charging under the lamp base
 Charging station included
 Power adapter not included



Dimmable 	7 hrs 	IP65	3 Years**
--------------	-----------	------	--------------

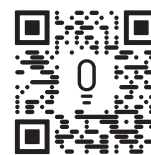

New. Thala Rechargeable Table Lamp IP65



Product Code	Color	Wattage	Voltage	Color Temp.	Luminous Flux	CRI	Dimmable	IP	Weight	RRP*
4565001	ceramics white/midnight black	2,3 W	3,7 V DC	2.700/2.200 K	220 lm	80	yes	IP65	710 g	116,81 €

This lamp contains built-in LED bulbs. The bulbs inside the lamp cannot be changed.
 ** Consumer warranty only. Warranty conditions on page 258.

With its mood-enhancing light, the Nucandle offers many applications – in a restaurant, on the patio or in the garden.





Nucandle

This lamp rises straight up into the room – like a candle. Its ceramic-coated surface in black or white impresses with its shimmering appearance. The atmospheric upward light creates a pleasant room atmosphere, similar to that of a candle. But only in combination with its downward light, its full potential is revealed. This combination makes it the perfect table lamp.



Downward lumination, upward ambient light
 2.700 K warm white
 Dimming via touch switch
 Lighting time: up to 6 hrs
 Rechargeable Li-ion battery, 1.500 mAh
 IP54, suitable for outdoor use
 Magnetic easy-connect puk connector

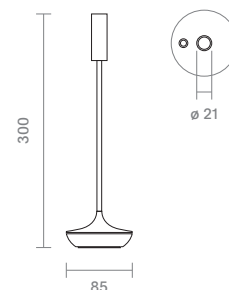

Charging via easy-connect puk port
 under the base of the luminaire

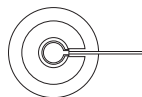

6-port charging station available
 (see Accessories on page 250)

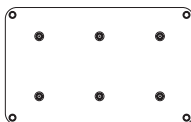

Dimmable 	6 hrs 	IP54	3 Years**
--------------	-----------	------	--------------

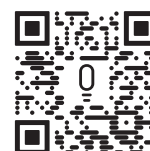

Nucandle Rechargeable Table Lamp IP54



Product Code	Color	Wattage	Voltage	Color Temp.	Luminous Flux	CRI	Dimmable	IP	Weight	RRP*
1 4564001	ceramics black	1,6 W	3,7 V DC	2.700 K	180 lm	85	yes	IP54	340 g	100,00 €
2 4564101	ceramics black/copper-colored	1,6 W	3,7 V DC	2.700 K	180 lm	85	yes	IP54	340 g	100,00 €
3 4564501	ceramics white	1,6 W	3,7 V DC	2.700 K	180 lm	85	yes	IP54	340 g	100,00 €
4 4564601	ceramics white/chrome	1,6 W	3,7 V DC	2.700 K	180 lm	85	yes	IP54	340 g	100,00 €

This lamp contains built-in LED bulbs. The bulbs inside the lamp cannot be changed.
 ** Consumer warranty only. Warranty conditions on page 258.





Diagonal genius: The Mahina table lamp adds an attractive decorative touch to any table.

Mahina Table Lamp

With its clear architectural design, the Mahina table lamp is a highlight for every minimalist living space. With its three high-quality glossy colors – white, black and chrome –, it harmonically blends into any surroundings.



Downward lumination
 Light disk can be removed and swiveled
 FlexMood Feature: 2.700 K + 2.200 K = warm white + warm white extra
 Dimming via touch feature on the lamp head
 Lighting time: up to 10 hrs
 Rechargeable Li-ion battery, 3.800 mAh
 3 glossy colors
 Battery replaceable (see Accessories on page 250)

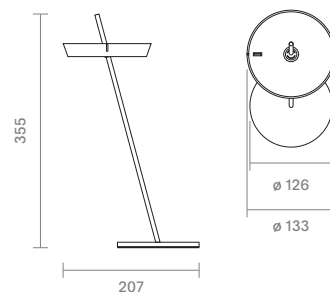

Charging using USB-C port
 under the light disk

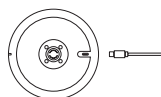

6-port charging station available
 (see Accessories on page 251)

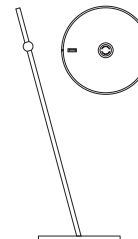
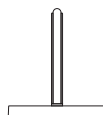

Dimmable 	10 hrs 	IP20	3 Years**
--------------	------------	------	--------------

Mahina Rechargeable Table Lamp

Glossy colors



	Product Code	Color	Wattage	Voltage	Color Temp.	Luminous Flux	CRI	Dimmable	IP	Weight	RRP*
1	4560001	ceramics black	2,2 W	3,7 V DC	2.700/2.200 K	181 lm/168 lm	85	yes	IP20	1.060 g	142,02 €
2	4560101	ceramics white	2,2 W	3,7 V DC	2.700/2.200 K	181 lm/168 lm	85	yes	IP20	1.060 g	142,02 €
3	4560201	chrome	2,2 W	3,7 V DC	2.700/2.200 K	181 lm/168 lm	85	yes	IP20	1.060 g	158,82 €

This lamp contains built-in LED bulbs. The bulbs inside the lamp cannot be changed.
 ** Consumer warranty only. Warranty conditions on page 258.

Mahina Floor Lamp

A clear statement for minimalism and straight lines: Like a soloist, the Mahina floor lamp positions itself confidently in the room. The FlexMood feature offers warm-white and glare-free light in two color temperatures using the touch dimmer. This way the luminaire always creates the right lighting. The head can be swiveled, enabling the precise placement of the light cone.



Downward lumination
 Light disk can be removed and swiveled
 FlexMood Feature: 2.700 K + 2.200 K = warm white + warm white extra
 Dimming via touch feature on the lamp head
 Lighting time: up to 10 hrs
 Rechargeable Li-ion battery, 3.800 mAh
 2 glossy colors
 Battery replaceable (see Accessories on page 250)

Charging using USB-C port
 under the light disk

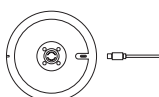

6-port charging station available
 (see Accessories on page 251)

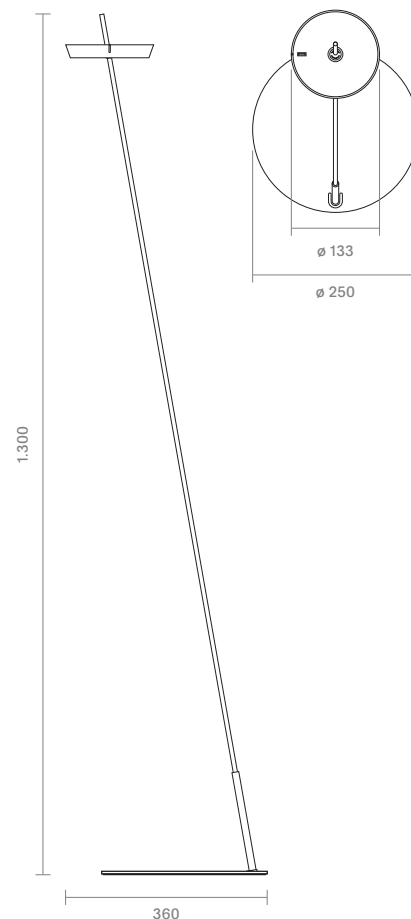
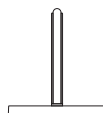

Dimmable 	10 hrs 	IP20	3 Years**
--------------	------------	------	--------------

Mahina Rechargeable Floor Lamp

Glossy colors



	Product Code	Color	Wattage	Voltage	Color Temp.	Luminous Flux	CRI	Dimmable	IP	Weight	RRP*
1	4561001	ceramics black	2,2 W	3,7 V DC	2.700/2.200 K	181 lm/168 lm	85	yes	IP20	2.080 g	217,65 €
2	4561101	ceramics white	2,2 W	3,7 V DC	2.700/2.200 K	181 lm/168 lm	85	yes	IP20	2.080 g	217,65 €

This lamp contains built-in LED bulbs. The bulbs inside the lamp cannot be changed.
 ** Consumer warranty only. Warranty conditions on page 258.

Mahina Pendant Lamp

The Mahina also makes a clear design statement as a pendant luminaire. Combined with the table lamp and the floor lamp, it creates an aesthetically pleasing luminaire ensemble – for a bit of Japan at home.



Downward lumination
 Removable light disk
 FlexMood Feature: 2.700 K + 2.200 K = warm white + warm white extra
 Dimming via touch feature on the lamp head
 Lighting time: up to 10 hrs
 Rechargeable Li-ion battery, 3.800 mAh
 2 glossy colors
 Battery replaceable (see Accessories on page 250)

Charging using USB-C port
 under the light disk

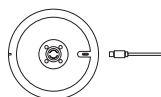

6-port charging station available
 (see Accessories on page 251)

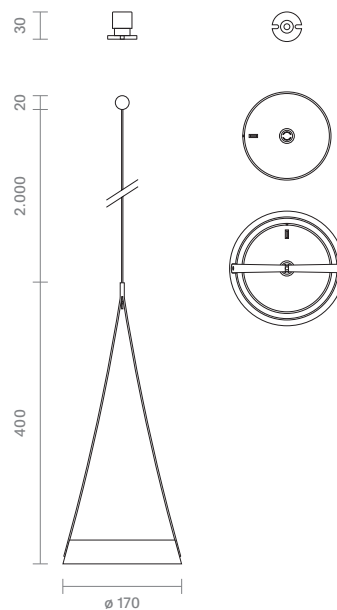
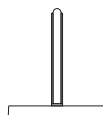

Dimmable 	10 hrs 	IP20	3 Years**
--------------	------------	------	--------------

Mahina Rechargeable Pendant Lamp

Glossy colors



	Product Code	Color	Wattage	Voltage	Color Temp.	Luminous Flux	CRI	Dimmable	IP	Weight	RRP*
1	4562001	ceramics black	2,2 W	3,7 V DC	2.700/2.200 K	181 lm/168 lm	85	yes	IP20	750 g	158,82 €
2	4562101	ceramics white	2,2 W	3,7 V DC	2.700/2.200 K	181 lm/168 lm	85	yes	IP20	750 g	158,82 €

This lamp contains built-in LED bulbs. The bulbs inside the lamp cannot be changed.
 ** Consumer warranty only. Warranty conditions on page 258.



A glare-free main light on the table,
atmospheric ambient light in the
bouquet of flowers



Nuflair: The rechargeable lamp
with included flower vase

Nuflair

The SIGOR Nuflair surprises with a very special highlight: The design icon from Italian designer Franco Pagliarini is a rechargeable lamp with an included flower vase. Not only does it bring glare-free and atmospheric light to the table, but also effectively highlights the flower arrangement.



Downward lumination, upward ambient light
 FlexMood Feature: 2.700 K + 2.200 K = warm white + warm white extra
 Dimming via touch feature on the lamp head
 Lighting time: up to 12 hrs
 Rechargeable Li-ion battery, 4.400 mAh
 7 matte colors, 1 metal version
 Powder-coated aluminum or matte anodized
 IP54, suitable for outdoor use
 Magnetic easy-connect puk connector
 Battery replaceable (see Accessories on page 250)

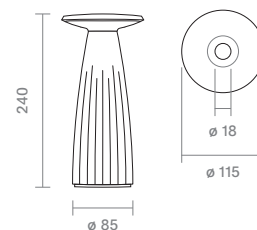

Charging via easy-connect puk port under the base of the luminaire

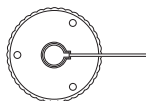

6-port charging station available (see Accessories on page 250)

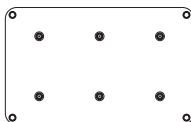

Dimmable 	12 hrs 	IP54	3 Years**
--------------	------------	------	--------------

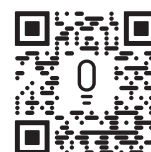

Nuflair Rechargeable Table Lamp IP54 Matte colors



	Product Code	Color	Wattage	Voltage	Color Temp.	Luminous Flux	CRI	Dimmable	IP	Weight	RRP*
1	4544101	midnight black/RAL 9011	2,2 W	3,7 V DC	2.700/2.200 K	170 lm/150 lm	85	yes	IP54	915 g	133,61 €
2	4544201	fog gray/RAL 7040	2,2 W	3,7 V DC	2.700/2.200 K	170 lm/150 lm	85	yes	IP54	915 g	133,61 €
3	4544301	snow white/RAL 9003	2,2 W	3,7 V DC	2.700/2.200 K	170 lm/150 lm	85	yes	IP54	915 g	133,61 €
4	4544401	flax beige/RAL 070 80 10	2,2 W	3,7 V DC	2.700/2.200 K	170 lm/150 lm	85	yes	IP54	915 g	133,61 €
5	4544501	sage green/RAL 130 60 10	2,2 W	3,7 V DC	2.700/2.200 K	170 lm/150 lm	85	yes	IP54	915 g	133,61 €
6	4544601	sun yellow/RAL 1012	2,2 W	3,7 V DC	2.700/2.200 K	170 lm/150 lm	85	yes	IP54	915 g	133,61 €
7	4544701	rust brown	2,2 W	3,7 V DC	2.700/2.200 K	170 lm/150 lm	85	yes	IP54	915 g	133,61 €

Nuflair Rechargeable Table Lamp, IP54 Metal version



	Product Code	Color	Wattage	Voltage	Color Temp.	Luminous Flux	CRI	Dimmable	IP	Weight	RRP*
	4544801	gold-colored	2,2 W	3,7 V DC	2.700/2.200 K	170 lm/150 lm	85	yes	IP54	915 g	158,82 €

This lamp contains built-in LED bulbs. The bulbs inside the lamp cannot be changed.
 ** Consumer warranty only. Warranty conditions on page 258.

Charming and extravagant:
If the SIGOR Nudrop did not
emit light, it would also pass
as a sculpture or design object.





Its narrow head, its wide base and a battery integrated into the base give the Nudrop a secure footing anywhere and everywhere.

Nudrop

With its curved shape and appealing colors, it adds original accents in any indoor environment. Despite its compact shape, it has an enormous luminosity. Thanks to its space-saving dimensions, it fits on any bistro table and never obstructs the view.



Downward lumination
 FlexMood Feature: 2.700 K + 2.200 K = warm white + warm white extra
 Dimming via touch feature on the lamp head
 Lighting time: up to 12 hrs
 Rechargeable Li-ion battery, 4.400 mAh
 7 matte colors, 1 metal version
 Powder-coated aluminum or matte anodized
 IP54, suitable for outdoor use
 Magnetic easy-connect puk connector
 Battery replaceable (see Accessories on page 250)

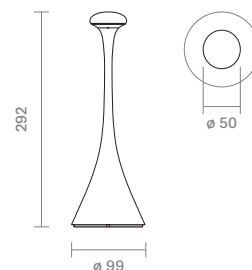

Charging via easy-connect puk port under the base of the luminaire

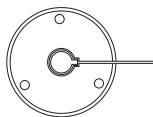

6-port charging station available (see Accessories on page 250)

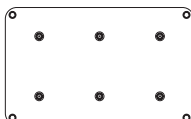

Dimmable 	12 hrs 	IP54 	3 Years**
--------------	------------	----------	------------------

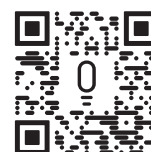

Nudrop Rechargeable Table Lamp IP54 Matte colors



Product Code	Color	Wattage	Voltage	Color Temp.	Luminous Flux	CRI	Dimmable	IP	Weight	RRP*
1 4540101	midnight black/RAL 9011	2,2 W	3,7 V DC	2.700/2.200 K	170 lm/155 lm	85	yes	IP54	350 g	100,00 €
2 4540201	graphite gray/RAL 7016	2,2 W	3,7 V DC	2.700/2.200 K	170 lm/155 lm	85	yes	IP54	350 g	100,00 €
3 4540301	snow white/RAL 9003	2,2 W	3,7 V DC	2.700/2.200 K	170 lm/155 lm	85	yes	IP54	350 g	100,00 €
4 4540401	flax beige/RAL 070 80 10	2,2 W	3,7 V DC	2.700/2.200 K	170 lm/155 lm	85	yes	IP54	350 g	100,00 €
5 4540501	sage green/RAL 130 60 10	2,2 W	3,7 V DC	2.700/2.200 K	170 lm/155 lm	85	yes	IP54	350 g	100,00 €
6 4540601	fiery red/RAL 3001	2,2 W	3,7 V DC	2.700/2.200 K	170 lm/155 lm	85	yes	IP54	350 g	100,00 €
7 4540701	sun yellow/RAL 1012	2,2 W	3,7 V DC	2.700/2.200 K	170 lm/155 lm	85	yes	IP54	350 g	100,00 €

Nudrop Rechargeable Table Lamp, IP54 Metal version



Product Code	Color	Wattage	Voltage	Color Temp.	Luminous Flux	CRI	Dimmable	IP	Weight	RRP*
4540801	gold-colored	2,2 W	3,7 V DC	2.700/2.200 K	170 lm/155 lm	85	yes	IP54	350 g	125,21 €

This lamp contains built-in LED bulbs. The bulbs inside the lamp cannot be changed.
 ** Consumer warranty only. Warranty conditions on page 258.

Nudrop mini

With its curved shape and appealing colors, it adds original accents in any indoor environment. Despite its compact shape, it has an enormous luminosity. Thanks to its low design, it never obscures the view of the person opposite.



Downward lumination
 FlexMood Feature: 2.700 K + 2.200 K = warm white + warm white extra
 Dimming via touch feature on the lamp head
 Lighting time: up to 7 hrs
 Rechargeable Li-ion battery, 2.200 mAh
 7 matte colors, 1 metal version
 Powder-coated aluminum or matte anodized
 IP54, suitable for outdoor use
 Magnetic easy-connect puk connector
 Battery replaceable (see Accessories on page 250)

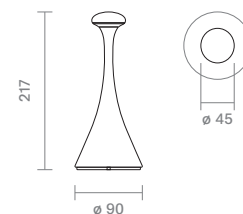

Charging via easy-connect puk port under the base of the luminaire

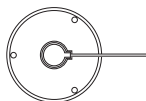

6-port charging station available (see Accessories on page 250)

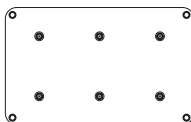

Dimmable

7 hrs

IP54

3
 Years**



Nudrop mini Rechargeable Table Lamp IP54 Matte colors



	Product Code	Color	Wattage	Voltage	Color Temp.	Luminous Flux	CRI	Dimmable	IP	Weight	RRP*
1	4541101	midnight black/RAL 9011	1,8 W	3,7 V DC	2.700/2.200 K	133 lm/113 lm	85	yes	IP54	255 g	91,60 €
2	4541201	graphite gray/RAL 7016	1,8 W	3,7 V DC	2.700/2.200 K	133 lm/113 lm	85	yes	IP54	255 g	91,60 €
3	4541301	snow white/RAL 9003	1,8 W	3,7 V DC	2.700/2.200 K	133 lm/113 lm	85	yes	IP54	255 g	91,60 €
4	4541401	flax beige/RAL 070 80 10	1,8 W	3,7 V DC	2.700/2.200 K	133 lm/113 lm	85	yes	IP54	255 g	91,60 €
5	4541501	sage green/RAL 130 60 10	1,8 W	3,7 V DC	2.700/2.200 K	133 lm/113 lm	85	yes	IP54	255 g	91,60 €
6	4541601	fiery red/RAL 3001	1,8 W	3,7 V DC	2.700/2.200 K	133 lm/113 lm	85	yes	IP54	255 g	91,60 €
7	4541701	sun yellow/RAL 1012	1,8 W	3,7 V DC	2.700/2.200 K	133 lm/113 lm	85	yes	IP54	255 g	91,60 €

Nudrop mini Rechargeable Table Lamp IP54 Metal version



	Product Code	Color	Wattage	Voltage	Color Temp.	Luminous Flux	CRI	Dimmable	IP	Weight	RRP*
	4541801	gold-colored	1,8 W	3,7 V DC	2.700/2.200 K	133 lm/113 lm	85	yes	IP54	255 g	116,81 €

This lamp contains built-in LED bulbs. The bulbs inside the lamp cannot be changed.
 ** Consumer warranty only. Warranty conditions on page 258.



With its slanted sides, the light in the Nutalis can unfold its unique effect.



Invisible light output and spacious downward lumination.



Nutalis

For bedside tables, desks and wherever large areas of light are required in a small space: The SIGOR Nutalis is a cube-shaped rechargeable lamp that emits a flat beam of light. The slanted sides of the cube reflect light in such a unique way that it looks like an art object when switched on.



Four-directional downward lumination
 FlexMood Feature: 2.700 K + 2.200 K = warm white + warm white extra
 Dimming via touch feature
 Lighting time: up to 9 hrs
 Rechargeable Li-ion battery, 4.400 mAh
 7 matte colors
 Aluminum, powder-coated
 IP54, suitable for outdoor use
 Magnetic easy-connect puk connector
 Battery replaceable (see Accessories on page 250)

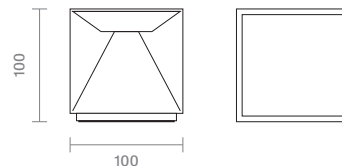

Charging via easy-connect puk port under the base of the luminaire

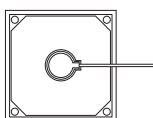

6-port charging station available (see Accessories on page 250)

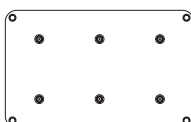

Dimmable 	9 hrs 	IP54	3 Years**
--------------	-----------	------	--------------

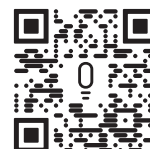

Nutalis Rechargeable Table Lamp IP54



Product Code	Color	Wattage	Voltage	Color Temp.	Luminous Flux	CRI	Dimmable	IP	Weight	RRP*
1 4517801	midnight black/RAL 9011	2,8 W	3,7 V DC	2.700/2.200 K	130 lm/120 lm	85	yes	IP54	565 g	100,00 €
2 4557201	graphite gray/RAL 7016	2,8 W	3,7 V DC	2.700/2.200 K	130 lm/120 lm	85	yes	IP54	565 g	100,00 €
3 4557101	fog gray/RAL 7040	2,8 W	3,7 V DC	2.700/2.200 K	130 lm/120 lm	85	yes	IP54	565 g	100,00 €
4 4517601	snow white/RAL 9003	2,8 W	3,7 V DC	2.700/2.200 K	130 lm/120 lm	85	yes	IP54	565 g	100,00 €
5 4517701	flax beige/RAL 070 80 10	2,8 W	3,7 V DC	2.700/2.200 K	130 lm/120 lm	85	yes	IP54	565 g	100,00 €
6 4557301	sage green/RAL 130 60 10	2,8 W	3,7 V DC	2.700/2.200 K	130 lm/120 lm	85	yes	IP54	565 g	100,00 €
7 4557401	fiery red/RAL 3001	2,8 W	3,7 V DC	2.700/2.200 K	130 lm/120 lm	85	yes	IP54	565 g	100,00 €

This lamp contains built-in LED bulbs. The bulbs inside the lamp cannot be changed.
 ** Consumer warranty only. Warranty conditions on page 258.

Nutalis mini

Cube-shaped rechargeable light with two functions: As a table lamp, the SIGOR Nutalis mini distributes its wide-area light in small spaces. With the included wall mount, it can be easily installed on any wall. The free rotation creates an atmospheric play of light.



Four-directional downward lumination
 Can be used as table or wall luminaire
 Two wall mounts included
 FlexMood Feature: 2.700 K + 2.200 K = warm white + warm white extra
 Dimming via touch feature
 Lighting time: up to 9 hrs
 Rechargeable Li-ion battery, 3.000 mAh
 7 matte colors
 Aluminum, powder-coated
 IP54, suitable for outdoor use
 Magnetic easy-connect puk connector
 Battery replaceable (see Accessories on page 250)

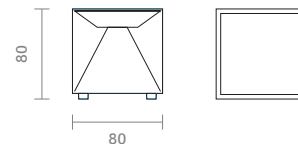

With the wall mount, it can be used as a wall luminaire

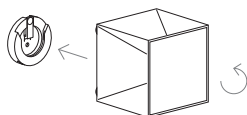

Charging via easy-connect puk port under the base of the luminaire

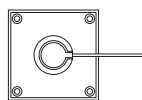

6-port charging station available (see Accessories on page 250)

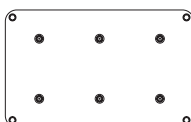

Dimmable 	9 hrs 	IP54	3 Years**
--------------	-----------	------	--------------

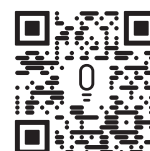

Nutalis mini Rechargeable Table Lamp IP54



Product Code	Color	Wattage	Voltage	Color Temp.	Luminous Flux	CRI	Dimmable	IP	Weight	RRP*
1 4519001	midnight black/RAL 9011	2,2 W	3,7 V DC	2.700/2.200 K	125 lm/108 lm	85	yes	IP54	325 g	91,60 €
2 4519101	graphite gray/RAL 7016	2,2 W	3,7 V DC	2.700/2.200 K	125 lm/108 lm	85	yes	IP54	325 g	91,60 €
3 4519401	fog gray/RAL 7040	2,2 W	3,7 V DC	2.700/2.200 K	125 lm/108 lm	85	yes	IP54	325 g	91,60 €
4 4519201	snow white/RAL 9003	2,2 W	3,7 V DC	2.700/2.200 K	125 lm/108 lm	85	yes	IP54	325 g	91,60 €
5 4519301	flax beige/RAL 070 80 10	2,2 W	3,7 V DC	2.700/2.200 K	125 lm/108 lm	85	yes	IP54	325 g	91,60 €
6 4519501	sage green/RAL 130 60 10	2,2 W	3,7 V DC	2.700/2.200 K	125 lm/108 lm	85	yes	IP54	325 g	91,60 €
7 4519601	fiery red/RAL 3001	2,2 W	3,7 V DC	2.700/2.200 K	125 lm/108 lm	85	yes	IP54	325 g	91,60 €

This lamp contains built-in LED bulbs. The bulbs inside the lamp cannot be changed.
 ** Consumer warranty only. Warranty conditions on page 258.



The high-quality, hand-blown lampshade makes each lamp unique. This way, the Numotion combines craftsmanship with the latest wireless LED technology.

Icons among themselves:
With its retro nuances, the Numotion
is a fitting counterpart to design classics
of the 20th century.



Numotion

Emotion in motion: A rechargeable lamp in vintage look and high-quality, handblown glass shade. With its indirect, warm light, it always creates a cozy environment. On the dinner table, in the living room or as a reading lamp on your night stand – it is always eye-catching.



Tinted lamp shade made from genuine, hand-blown glass
 FlexMood Feature: 2.700 K + 2.200 K = warm white + warm white extra
 Dimming via touch switch
 Lighting time: up to 12 hrs
 Rechargeable Li-ion battery, 4.400 mAh
 Powder-coated aluminum or matte anodized
 IP54, suitable for outdoor use
 Magnetic easy-connect puk connector
 Battery replaceable (see Accessories on page 250)

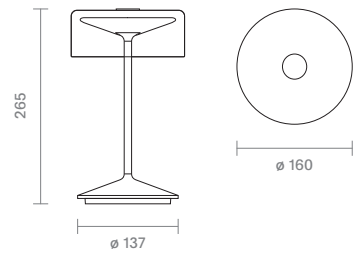

Charging via easy-connect puk port under the base of the luminaire

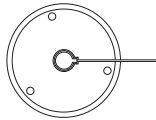

6-port charging station available (see Accessories on page 250)

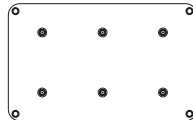

Dimmable 	12 hrs 	IP54 	3 Years**
--------------	------------	----------	------------------

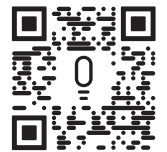

Numotion Rechargeable Table Lamp IP54 Matte colors

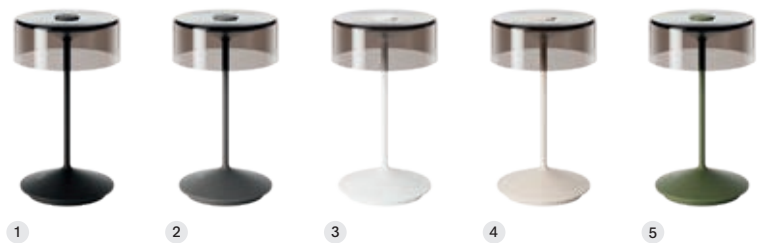

Product Code	Color	Wattage	Voltage	Color Temp.	Luminous Flux	CRI	Dimmable	IP	Weight	RRP*
1 4525001	midnight black/RAL 9011	2,2 W	3,7 V DC	2.700/2.200 K	160 lm/140 lm	85	yes	IP54	820 g	158,82 €
2 4525201	graphite gray/RAL 7016	2,2 W	3,7 V DC	2.700/2.200 K	160 lm/140 lm	85	yes	IP54	820 g	158,82 €
3 4525101	snow white/RAL 9003	2,2 W	3,7 V DC	2.700/2.200 K	160 lm/140 lm	85	yes	IP54	820 g	158,82 €
4 4525401	flax beige/RAL 070 80 10	2,2 W	3,7 V DC	2.700/2.200 K	160 lm/140 lm	85	yes	IP54	820 g	158,82 €
5 4525501	fir green/RAL 6003	2,2 W	3,7 V DC	2.700/2.200 K	160 lm/140 lm	85	yes	IP54	820 g	158,82 €

Numotion Rechargeable Table Lamp IP54 Metal versions

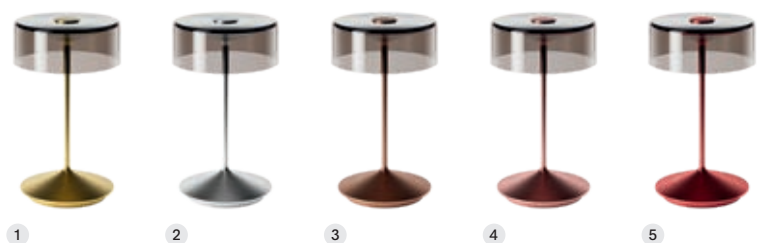

Product Code	Color	Wattage	Voltage	Color Temp.	Luminous Flux	CRI	Dimmable	IP	Weight	RRP*
1 4525901	gold-colored	2,2 W	3,7 V DC	2.700/2.200 K	160 lm/140 lm	85	yes	IP54	820 g	180,67 €
2 4525801	silver-colored	2,2 W	3,7 V DC	2.700/2.200 K	160 lm/140 lm	85	yes	IP54	820 g	180,67 €
3 4526001	bronze-colored	2,2 W	3,7 V DC	2.700/2.200 K	160 lm/140 lm	85	yes	IP54	820 g	180,67 €
4 4525601	rose gold	2,2 W	3,7 V DC	2.700/2.200 K	160 lm/140 lm	85	yes	IP54	820 g	180,67 €
5 4525701	cherry red	2,2 W	3,7 V DC	2.700/2.200 K	160 lm/140 lm	85	yes	IP54	820 g	180,67 €

This lamp contains built-in LED bulbs. The bulbs inside the lamp cannot be changed.
 ** Consumer warranty only. Warranty conditions on page 258.

The Swiss knife of
table lamps:

The Nuindie tango has a light head that can be swiveled and shine into two different directions. With wall mounts and a lamp shade that can be split in the middle, the table lamp can be converted into two separate wall luminaires within seconds.



Nuindie tango

It takes two to tango: The SIGOR Nuindie tango is our first rechargeable lamp with a lamp shade that can be split in the middle. Both halves of the lamp can be turned in the same direction or against each other. For even greater flexibility: Using the included wall mounts, it can also be used as a wall luminaire.



Upward and downward lumination
 Can be used as table or wall luminaire
 Two magnetic wall mounts included
 FlexMood Feature: 2.700 K + 2.200 K = warm white + warm white extra
 Dimming via touch switch
 Lighting time: up to 12 hrs
 Rechargeable Li-ion battery, 2 x 2.200 mAh
 Aluminum, powder-coated
 Convenient charging in the base of the luminaire using USB-C:
 Battery replaceable (see Accessories on page 250)

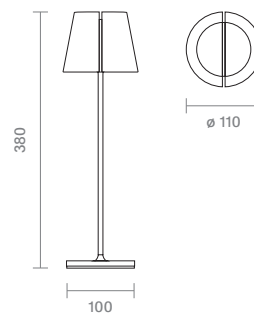

45° rotatable

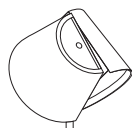

2-part lamp shade

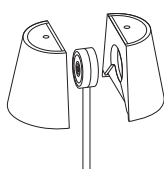

With the wall mount, it can be used as a wall luminaire

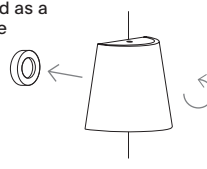

Charging in the base of the luminaire using USB-C

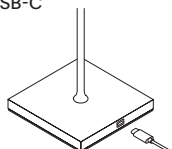

6-port charging station available (see Accessories on page 250)

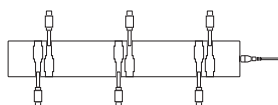

Dimmable 	12 hrs 	IP54	3 Years**
--------------	------------	------	--------------

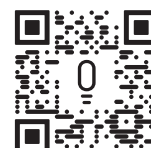

Nuindie tango IP54



	Product Code	Shape	Color	Wattage	Voltage	Color Temp.	Luminous Flux	CRI	Dimmable	IP	Weight	RRP*
1	4550001	round	midnight black/RAL 9011	2,2 W	3,7 V DC	2.700/2.200 K	197 lm/168 lm	85	yes	IP54	1.280 g	133,61 €
2	4550101	round	snow white/RAL 9003	2,2 W	3,7 V DC	2.700/2.200 K	197 lm/168 lm	85	yes	IP54	1.280 g	133,61 €

This lamp contains built-in LED bulbs. The bulbs inside the lamp cannot be changed.
 ** Consumer warranty only. Warranty conditions on page 258.



Nuindie mini: The compact companion for a long evening out in the big wide world: With its long-lasting rechargeable battery, it provides sufficient light for up to 12 hours.

Small but powerful: Despite its small dimensions, the Nuindie pocket offers a wide range of features: Different color temperatures, smooth dimming, easy charging, long battery life: The Nuindie pocket always delivery comfortable light.

As a floor lamp or table lamp: the Nuindie cuts a fine figure in any stylish home. Whatever combination you choose: The overall picture is always harmonious.



Nuindie's ambient lighting is created by a well-designed combination of focused downward light and glare-free upward light.



Nuindie pocket

Have you ever wished you could put your Nuindie in your pocket and take it with you everywhere you go? The Nuindie pocket makes it possible. Camping, picknicking, on an airplane or on vacation – Nuindie pocket is always on board.



Upward and downward lumination
 FlexMood Feature: 2.700 K + 2.200 K = warm white + warm white extra
 Dimming via touch switch
 Lighting time: up to 7 hrs
 Rechargeable Li-ion battery, 1.500 mAh
 Aluminum, powder-coated
 IP54, suitable for outdoor use
 Convenient charging in the base of the luminaire using USB-C:
 Battery replaceable (see Accessories on page 250)

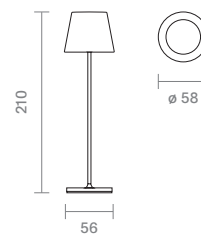

Charging in the base of the luminaire using USB-C

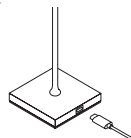

6-port charging station available (see Accessories on page 250)

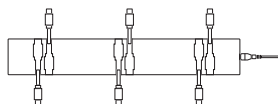

Dimmable 	7 hrs 	IP54	3 Years**
--------------	-----------	------	--------------

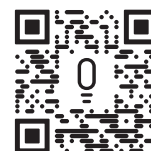

Nuindie pocket Rechargeable Table Lamp IP54 Matte colors



	Product Code	Shape	Color	Wattage	Voltage	Color Temp.	Luminous Flux	CRI	Dimmable	IP	Weight	RRP*
1	4543101	round	midnight black/RAL 9011	1,4 W	3,7 V DC	2.700/2.200 K	130 lm/115 lm	85	yes	IP54	295 g	79,83 €
2	4543201	round	graphite gray/RAL 7016	1,4 W	3,7 V DC	2.700/2.200 K	130 lm/115 lm	85	yes	IP54	295 g	79,83 €
3	4543801	round	fog gray/RAL 7040	1,4 W	3,7 V DC	2.700/2.200 K	130 lm/115 lm	85	yes	IP54	295 g	79,83 €
4	4543301	round	snow white/RAL 9003	1,4 W	3,7 V DC	2.700/2.200 K	130 lm/115 lm	85	yes	IP54	295 g	79,83 €
5	4543401	round	flax beige/RAL 070 80 10	1,4 W	3,7 V DC	2.700/2.200 K	130 lm/115 lm	85	yes	IP54	295 g	79,83 €
6	4543501	round	sage green/RAL 130 60 10	1,4 W	3,7 V DC	2.700/2.200 K	130 lm/115 lm	85	yes	IP54	295 g	79,83 €
7	4543901	round	fir green/RAL 6003	1,4 W	3,7 V DC	2.700/2.200 K	130 lm/115 lm	85	yes	IP54	295 g	79,83 €
8	4551001	round	dolphin blue/RAL 240 50 20	1,4 W	3,7 V DC	2.700/2.200 K	130 lm/115 lm	85	yes	IP54	295 g	79,83 €
9	4543601	round	fiery red/RAL 3001	1,4 W	3,7 V DC	2.700/2.200 K	130 lm/115 lm	85	yes	IP54	295 g	79,83 €
10	4543701	round	sun yellow/RAL 1012	1,4 W	3,7 V DC	2.700/2.200 K	130 lm/115 lm	85	yes	IP54	295 g	79,83 €

This lamp contains built-in LED bulbs. The bulbs inside the lamp cannot be changed.
 ** Consumer warranty only. Warranty conditions on page 258.

Nuindie

Their design language is so natural, timeless and clear: The rechargeable lights in the Nuindie family have numerous innovative features. They are available in a wide range of color and metal versions and in four sizes.



Upward and downward lumination
 FlexMood Feature: 2.700 K + 2.200 K = warm white + warm white extra
 Dimming via touch switch
 Lighting time: up to 12 hrs
 Rechargeable Li-ion battery, 4.400 mAh
 Powder-coated aluminum or anodized
 IP54, suitable for outdoor use
 Convenient charging in the base of the luminaire using USB-C:
 Battery replaceable (see Accessories on page 250)

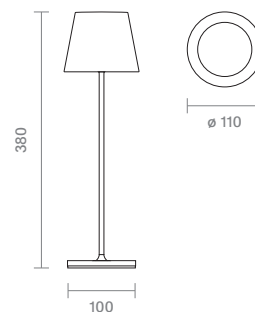

Charging in the base of the luminaire using USB-C

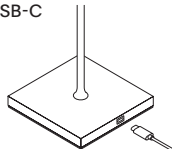

6-port charging station available (see Accessories on page 250)

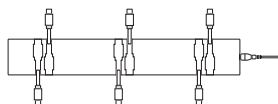

Dimmable 	12 hrs 	IP54	3 Years**
--------------	------------	------	--------------



Nuindie Rechargeable Table Lamp IP54 Matte colors



	Product Code	Shape	Color	Wattage	Voltage	Color Temp.	Luminous Flux	CRI	Dimmable	IP	Weight	RRP*
1	4545001	round	midnight black/RAL 9011	2,2 W	3,7 V DC	2.700/2.200 K	197 lm/168 lm	85	yes	IP54	1.020 g	120,17 €
2	4545101	round	graphite gray/RAL 7016	2,2 W	3,7 V DC	2.700/2.200 K	197 lm/168 lm	85	yes	IP54	1.020 g	120,17 €
3	4545401	round	fog gray/RAL 7040	2,2 W	3,7 V DC	2.700/2.200 K	197 lm/168 lm	85	yes	IP54	1.020 g	120,17 €
4	4545201	round	snow white/RAL 9003	2,2 W	3,7 V DC	2.700/2.200 K	197 lm/168 lm	85	yes	IP54	1.020 g	120,17 €
5	4545301	round	flax beige/RAL 070 80 10	2,2 W	3,7 V DC	2.700/2.200 K	197 lm/168 lm	85	yes	IP54	1.020 g	120,17 €
6	4545501	round	sage green/RAL 130 60 10	2,2 W	3,7 V DC	2.700/2.200 K	197 lm/168 lm	85	yes	IP54	1.020 g	120,17 €
7	4545601	round	fir green/RAL 6003	2,2 W	3,7 V DC	2.700/2.200 K	197 lm/168 lm	85	yes	IP54	1.020 g	120,17 €
8	4545801	round	dolphin blue/RAL 240 50 20	2,2 W	3,7 V DC	2.700/2.200 K	197 lm/168 lm	85	yes	IP54	1.020 g	120,17 €
9	4545901	round	fiery red/RAL 3001	2,2 W	3,7 V DC	2.700/2.200 K	197 lm/168 lm	85	yes	IP54	1.020 g	120,17 €
10	4548701 New	round	glowing orange/RAL 2004	2,2 W	3,7 V DC	2.700/2.200 K	197 lm/168 lm	85	yes	IP54	1.020 g	120,17 €
11	4546001	round	sun yellow/RAL 1012	2,2 W	3,7 V DC	2.700/2.200 K	197 lm/168 lm	85	yes	IP54	1.020 g	120,17 €

Nuindie Rechargeable Table Lamp, IP54 Metal versions



	Product Code	Shape	Color	Wattage	Voltage	Color Temp.	Luminous Flux	CRI	Dimmable	IP	Weight	RRP*
1	4546101	round	gold-colored	2,2 W	3,7 V DC	2.700/2.200 K	197 lm/168 lm	85	yes	IP54	1.020 g	146,22 €
2	4546201	round	silver-colored	2,2 W	3,7 V DC	2.700/2.200 K	197 lm/168 lm	85	yes	IP54	1.020 g	146,22 €
3	4546301	round	bronze-colored	2,2 W	3,7 V DC	2.700/2.200 K	197 lm/168 lm	85	yes	IP54	1.020 g	146,22 €
4	4546401	round	copper-colored	2,2 W	3,7 V DC	2.700/2.200 K	197 lm/168 lm	85	yes	IP54	1.020 g	146,22 €
5	4546601	round	rose gold	2,2 W	3,7 V DC	2.700/2.200 K	197 lm/168 lm	85	yes	IP54	1.020 g	146,22 €
6	4546501	round	cherry red	2,2 W	3,7 V DC	2.700/2.200 K	197 lm/168 lm	85	yes	IP54	1.020 g	146,22 €

This lamp contains built-in LED bulbs. The bulbs inside the lamp cannot be changed.
 ** Consumer warranty only. Warranty conditions on page 258.

Nuindie mini

Their design language is so natural, timeless and clear that they fit into any interior or exterior. The rechargeable lights in the Nuindie family have numerous innovative features. The Nuindie mini features a shortened design, so it can fit on any table.

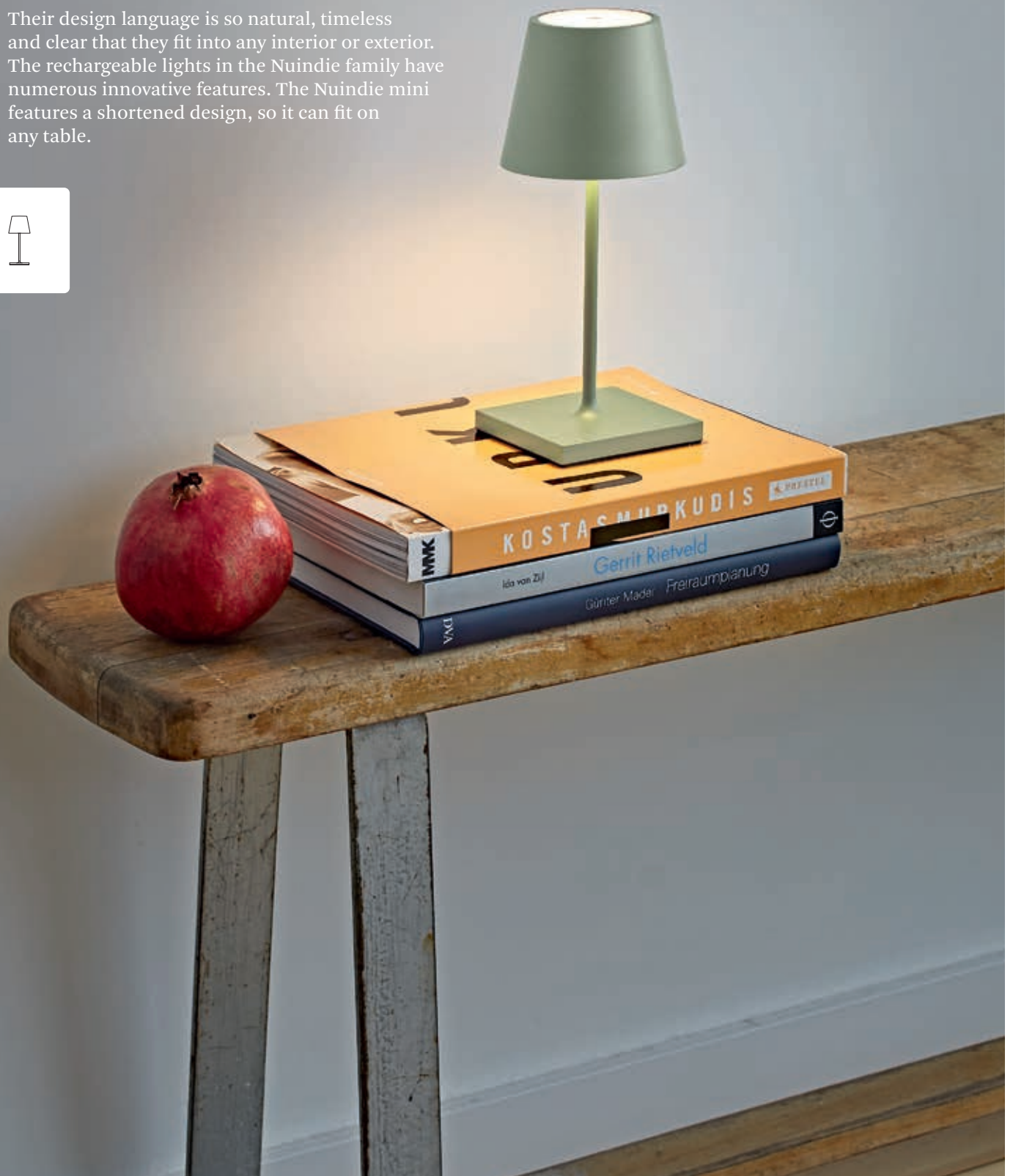

Upward and downward lumination
 FlexMood Feature: 2.700 K + 2.200 K = warm white + warm white extra
 Dimming via touch switch
 Lighting time: up to 12 hrs
 Rechargeable Li-ion battery, 4.400 mAh
 Powder-coated aluminum or anodized
 IP54, suitable for outdoor use
 Convenient charging in the base of the luminaire using USB-C:
 Battery replaceable (see Accessories on page 250)

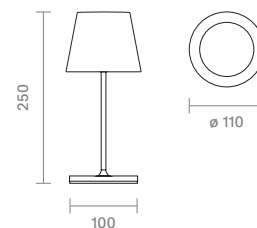

Charging in the base of the luminaire using USB-C

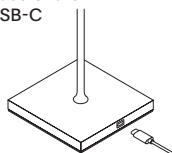

6-port charging station available (see Accessories on page 250)

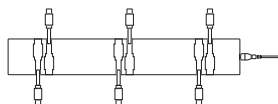

Dimmable 	12 hrs 	IP54	3 Years**
--------------	------------	------	--------------



Nuindie mini Rechargeable Table Lamp IP54 Matte colors



	Product Code	Shape	Color	Wattage	Voltage	Color Temp.	Luminous Flux	CRI	Dimmable	IP	Weight	RRP*
1	4547001	round	midnight black/RAL 9011	2,2 W	3,7 V DC	2.700/2.200 K	197 lm/168 lm	85	yes	IP54	935 g	115,97 €
2	4547101	round	graphite gray/RAL 7016	2,2 W	3,7 V DC	2.700/2.200 K	197 lm/168 lm	85	yes	IP54	935 g	115,97 €
3	4547201	round	snow white/RAL 9003	2,2 W	3,7 V DC	2.700/2.200 K	197 lm/168 lm	85	yes	IP54	935 g	115,97 €
4	4547301	round	flax beige/RAL 070 80 10	2,2 W	3,7 V DC	2.700/2.200 K	197 lm/168 lm	85	yes	IP54	935 g	115,97 €
5	4547401	round	sage green/RAL 130 60 10	2,2 W	3,7 V DC	2.700/2.200 K	197 lm/168 lm	85	yes	IP54	935 g	115,97 €
6	4547501	round	fir green/RAL 6003	2,2 W	3,7 V DC	2.700/2.200 K	197 lm/168 lm	85	yes	IP54	935 g	115,97 €
7	4547701	round	fiery red/RAL 3001	2,2 W	3,7 V DC	2.700/2.200 K	197 lm/168 lm	85	yes	IP54	935 g	115,97 €

Nuindie mini Rechargeable Table Lamp IP54 Metal versions



	Product Code	Shape	Color	Wattage	Voltage	Color Temp.	Luminous Flux	CRI	Dimmable	IP	Weight	RRP*
1	4547801	round	gold-colored	2,2 W	3,7 V DC	2.700/2.200 K	197 lm/168 lm	85	yes	IP54	935 g	142,02 €
2	4547901	round	silver-colored	2,2 W	3,7 V DC	2.700/2.200 K	197 lm/168 lm	85	yes	IP54	935 g	142,02 €
3	4548001	round	bronze-colored	2,2 W	3,7 V DC	2.700/2.200 K	197 lm/168 lm	85	yes	IP54	935 g	142,02 €
4	4548101	round	rose gold	2,2 W	3,7 V DC	2.700/2.200 K	197 lm/168 lm	85	yes	IP54	935 g	142,02 €
5	4548201	round	cherry red	2,2 W	3,7 V DC	2.700/2.200 K	197 lm/168 lm	85	yes	IP54	935 g	142,02 €

This lamp contains built-in LED bulbs. The bulbs inside the lamp cannot be changed.
 ** Consumer warranty only. Warranty conditions on page 258.

Nuindie Floor Lamp

Their design language is so natural, timeless and clear that they fit into any interior or exterior. The rechargeable lights in the Nuindie family have numerous innovative features. The Nuindie floor lamp is suitable as a cordless side lamp for cozy evenings spent reading.

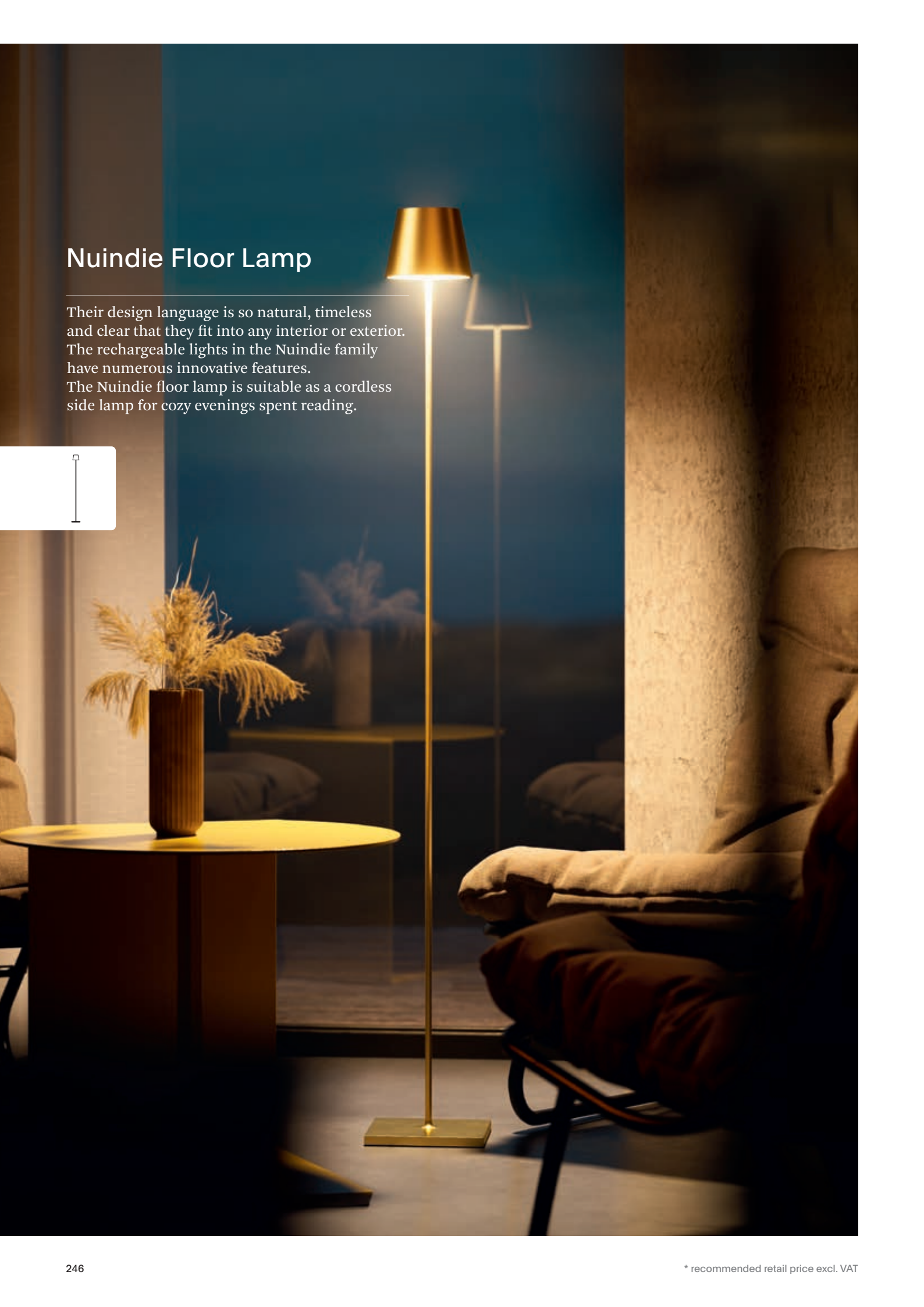

Upward and downward lumination
 FlexMood Feature: 2.700 K + 2.200 K = warm white + warm white extra
 Dimming via touch switch
 Lighting time: up to 12 hrs
 Rechargeable Li-ion battery, 4.400 mAh
 Powder-coated aluminum or anodized
 IP54, suitable for outdoor use
 Convenient charging in the base of the luminaire using USB-C:
 Battery replaceable (see Accessories on page 250)

Charging in the base of the luminaire using USB-C

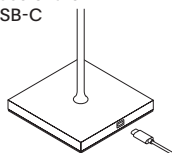

6-port charging station available (see Accessories on page 250)

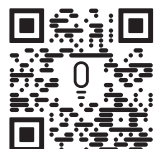
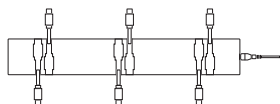

Dimmable 	12 hrs 	IP54	3 Years**
--------------	------------	------	--------------

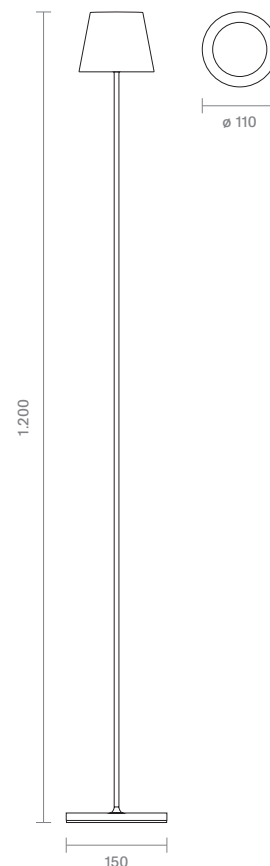

Nuindie Rechargeable Floor Lamp IP54 Matte colors



	Product Code	Shape	Color	Wattage	Voltage	Color Temp.	Luminous Flux	CRI	Dimmable	IP	Weight	RRP*
1	4549001	round	midnight black/RAL 9011	2,2 W	3,7 V DC	2.700/2.200 K	197 lm/168 lm	85	yes	IP54	2,30 kg	226,05 €
2	4549101	round	graphite gray/RAL 7016	2,2 W	3,7 V DC	2.700/2.200 K	197 lm/168 lm	85	yes	IP54	2,30 kg	226,05 €
3	4549201	round	snow white/RAL 9003	2,2 W	3,7 V DC	2.700/2.200 K	197 lm/168 lm	85	yes	IP54	2,30 kg	226,05 €
4	4549301	round	flax beige/RAL 070 80 10	2,2 W	3,7 V DC	2.700/2.200 K	197 lm/168 lm	85	yes	IP54	2,30 kg	226,05 €
5	4549401	round	fir green/RAL 6003	2,2 W	3,7 V DC	2.700/2.200 K	197 lm/168 lm	85	yes	IP54	2,30 kg	226,05 €
6	4549501	round	sun yellow/RAL 1012	2,2 W	3,7 V DC	2.700/2.200 K	197 lm/168 lm	85	yes	IP54	2,30 kg	226,05 €

Nuindie Rechargeable Floor Lamp IP54 Metal versions



	Product Code	Shape	Color	Wattage	Voltage	Color Temp.	Luminous Flux	CRI	Dimmable	IP	Weight	RRP*
1	4549601	round	gold-colored	2,2 W	3,7 V DC	2.700/2.200 K	197 lm/168 lm	85	yes	IP54	2,30 kg	259,66 €
2	4549701	round	silver-colored	2,2 W	3,7 V DC	2.700/2.200 K	197 lm/168 lm	85	yes	IP54	2,30 kg	259,66 €
3	4549801	round	bronze-colored	2,2 W	3,7 V DC	2.700/2.200 K	197 lm/168 lm	85	yes	IP54	2,30 kg	259,66 €

This lamp contains built-in LED bulbs. The bulbs inside the lamp cannot be changed.
 ** Consumer warranty only. Warranty conditions on page 258.

Accessories

For every situation the perfect accessory:
Upgrade Nuindie lamps to USB-C,
replace the glass shade of a Numotion
or give the Nudrop a new battery –
we offer the necessary accessories.





Thanks to the modular composition of our rechargeable lamps, the individual components can be quickly and easily replaced.



With our well-designed charging stations, you can charge several lights at the same time in a space-saving manner.

Nuindie Replacement Base, Nuindie mini USB-C Upgrade to USB-C port

	Product Code	Color	RRP*
1	4591001	midnight black/RAL 9011	20,17 €
1	4591101	graphite gray/RAL 7016	20,17 €
1	4591201	snow white/RAL 9003	20,17 €
1	4591301	flax beige/RAL 070 80 10	20,17 €
2	4592001	midnight black/RAL 9011	17,65 €
2	4592101	graphite gray/RAL 7016	17,65 €
2	4592201	snow white/RAL 9003	17,65 €
2	4592301	flax beige/RAL 070 80 10	17,65 €



Charging Cable with Power Adapter Includes 5 V / 1 A USB power adapter

	Product Code	Color	Output	Length	RRP*
1	4509801	black	5 V/1 A	120 cm	15,97 €
1	4509901	white	5 V/1 A	120 cm	15,97 €
2	4590101	black	5 V/1 A	120 cm	15,97 €
2	4590201	white	5 V/1 A	120 cm	15,97 €
3	4590301	black	5 V/1 A	120 cm	15,97 €
3	4590401	white	5 V/1 A	120 cm	15,97 €
4	4590501	black	5 V/1 A	120 cm	15,97 €
4	4590601	white	5 V/1 A	120 cm	15,97 €

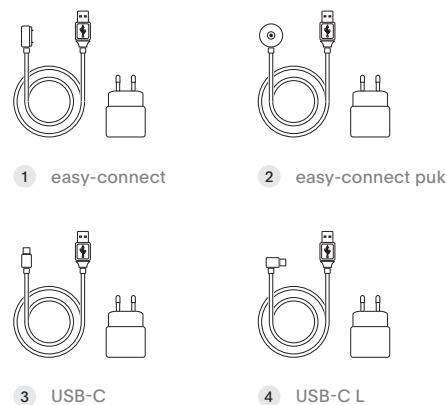

Replacement Battery, Rechargeable

	Product Code	Output voltage	Capacity	RRP*
1	4508401	3,7 V DC	4.400 mAh	20,17 €
2	4559901	3,7 V DC	1.500 mAh	15,13 €
3	4541901	3,7 V DC	2 x 2.200 mAh	20,17 €
4	4559801	3,7 V DC	2.200 mAh	10,08 €
5	4559501	3,7 V DC	3.000 mAh	20,17 €
6	4559601	3,7 V DC	2 x 1.900 mAh	29,41 €

Tutorial video for battery replacement

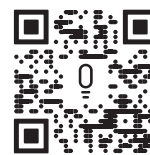

1	Replacement rechargeable battery for Nuindie, Nuindie mini, Nuindie square, Nuindie Floor Lamp and Nutalis		4	Replacement rechargeable battery for Nudrop mini	
2	Replacement rechargeable battery for Nuindie pocket		5	Replacement rechargeable battery for Nutalis mini and Nudiderot	
3	Replacement rechargeable battery for Nudrop, Nuffair and Numotion		6	Replacement rechargeable battery for Mahina	

6-way USB-C Charging Station

Simultaneous charging of 1-6 battery lights using USB-C ports on the sides of the charging station
Flat design, easy to stow away
Mains adapter included

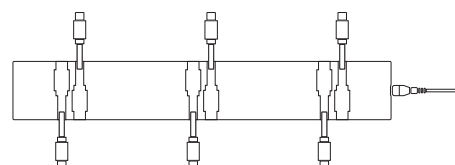

Product Code	Color	Style	Output	Dimensions (L x W x H)	IP	Weight	RRP*
4559101	black	6-way	5 V/7 A	335 x 30 x 15 mm	IP20	420 g	68,91 €

6-way Charging Station Easy-Connect Puk

Simultaneous charging of 1-6 battery lights with easy-connect puk port at the bottom
3-level, space-saving charging by stacking the luminaires.
Includes 4 spacers

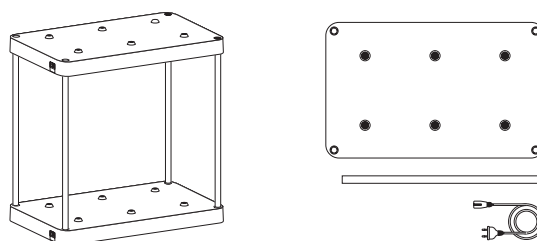

Product Code	Color	Style	Output	Dimensions (L x W x H)	IP	Weight	RRP*
4559001	grey	6-way	5 V/7 A	530 x 330 x 42 mm	IP20	2.060 g	120,17 €

New. Thala Charging Station

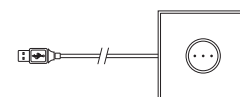

Product Code	Color	Style	Output	Charging station dimensions (L x W x H)	Cable length	IP	Weight	RRP*
4590701	black	1-way	5 V/1 A	70 x 70 x 15 mm	140 cm	IP20	67,5 g	15,04 €

6-way Charging Station for Mahina

—
 Simultaneous charging of 1-6 Mahina disk lights
 Flat design, easy to stow away
 Mains adapter included

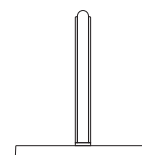

Product Code	Color	Style	Output	Dimensions (diameter x H)	IP	Weight	RRP*
4559201	black	6-way	5 V/7 A	135 x 160 mm	IP20	280 g	83,19 €

Replacement Lamp Shade For Numotion



Product Code	RRP*
4526901	32,77 €

Nuflair Vase Insert And Cap (Set)

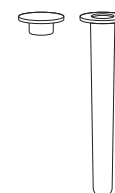

Product Code	RRP*
4544901	5,04 €

Numove

It looks so light and delicate that you hardly notice its technical refinements: The Numove outdoor light can be charged using a solar panel or a normal wall socket; at dusk, it switches on automatically; and can be smoothly dimmed. With its integrated carrying handle and a foldable wall hook, it brings its warm light to many places.



Free-standing battery lamp with flexible use
 High-performance solar panel, monocrystalline 110 x 110 mm
 Additional charging option using USB-C
 Foldaway carrying handle
 Thanks to the included foldable wall hook,
 the Numove can also be used as a wall light
 Warm white 2.700 K
 Selection switch for auto turn-on at <50 Lux
 Powerful rechargeable Li-Ion battery with 3.600 mAh
 Lighting time: up to 12 hrs
 IP54, suitable for outdoor use
 Material: die-cast aluminum, graphite gray, powder coated

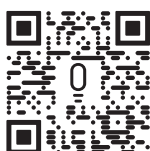
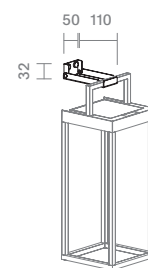
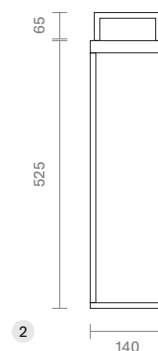
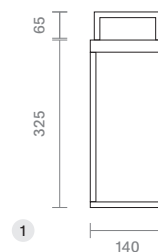

Numove Rechargeable Solar Light IP54

Dimmable 	<50 Lux 	IP54	3 Years**
--------------	-------------	------	--------------



	Product Code	Color	Wattage	Voltage	Color Temp.	Luminous Flux	CRI	Dimmable	IP	Weight	RRP*
1	4515601	graphite gray/RAL 7016	2,2 W	3,7 V DC	2.700 K	172 lm	85	yes	IP54	1,12 kg	150,42 €
2	4515701	graphite gray/RAL 7016	2,2 W	3,7 V DC	2.700 K	172 lm	85	yes	IP54	1,22 kg	158,82 €

This lamp contains built-in LED bulbs. The bulbs inside the lamp cannot be changed.
 ** Consumer warranty only. Warranty conditions on page 258.

Nusolar



Whether on your garden path or as snug patio lighting: The Nusolar outdoor light is completely self-sufficient. A high-quality solar panel and intelligent sensors provide discreet light at night, which flares up brightly as soon as you approach the lamp. During the day, the Nusolar switches itself off and recharges automatically for its next use.

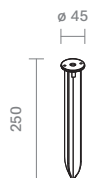
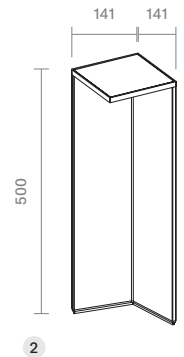
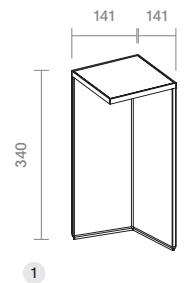

Flexible floor light with a high-performance solar panel
 Wide illumination angle of 74° for gardens, patios and path lighting
 Invisible screw fastening or floor spike
 Stable on the floor even without fastening
 Warm white 2.700 K
 High-performance solar panel, monocrystalline 140 x 140 mm
 Double sensor: Motion detection range 6 m: Light output 100 %, after 30 seconds without movement, output: 15 %, switch on/off at 20 Lux
 Powerful rechargeable Li-Ion battery with 2.200 mAh
 Lighting time: 3 h at 100 % output, 25 h at 15 % output
 IP54, suitable for outdoor use
 Material: die-cast aluminum, graphite gray, powder coated



Nusolar Rechargeable Solar Light

<20 Lux 	100 % 15 % 	IP54	3 Years**
--	--	------	--------------



	Product Code	Color	Wattage	Voltage	Color Temp.	Luminous Flux	CRI	Dimmable	IP	Weight	RRP*
1	4502701	graphite gray/RAL 7016	2,2 W	3,7 V DC	2.700 K	151 lm	85	no	IP54	1,99 kg	150,42 €
2	4502801	graphite gray/RAL 7016	2,2 W	3,7 V DC	2.700 K	151 lm	85	no	IP54	2,66 kg	167,23 €

This lamp contains built-in LED bulbs. The bulbs inside the lamp cannot be changed.
 ** Consumer warranty only. Warranty conditions on page 258.

Glossary



Strips marked with this icon can be customized. Only the quantities delivered in the specified unit are invoiced. Strips without this icon can also be customized, but the customer will be charged for cutoffs, which will also be shipped. For further information on our customization service, see page 100–101.



This number shows the number of LEDs per meter. Higher numbers mean more homogeneous linear light.



“Standard Deviation of Color Matching” (SDCM) indicates how closely the LEDs match within one production. Color deviations of 3 SDCM are considered “barely perceptible.” Quality-conscious manufacturers ensure that the dispersion of the LEDs does not exceed 5 SDCM.



The direction of the color difference in the color space remains the same during binning, so that different production batches do not exhibit any noticeable color deviations.



How many hours a rechargeable lamp is expected to operate after a full recharge.



The ENEC symbol (ENEC = European Norms Electrical Certification) is the European safety mark for lighting equipment, ballasts, starters, capacitors, converters, and transformers. It symbolizes uniform testing conditions. It can only be certified by certification bodies accredited by the European Committee for Electrotechnical Standardization (CENELEC).



Individual setting of the brightness of a lamp or bulb. It is controlled using forward or reverse phase dimming. Modern LED dimmers can work with both technologies and detect automatically, what kind of appliance is connected.



When dimmed, thermal radiators such as halogen or incandescent lamps change the color temperature into the red range. The light feels “warmer”. The same effect can be felt during sunset. Due to physics, LED bulbs are incapable of this. With the Dim-To-Warm technology, white and warm-white LEDs are controlled during dimming in such a way that they follow the color temperature curve of natural light sources.

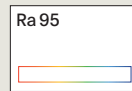

CRI (Ra): General color rendering index. Average color rendering of 14 reference colors according to DIN 6169. While daylight and thermal radiators like incandescent or halogen light bulbs have a color rendering index of 100, the CRI value of LED bulbs is lower. Average LED bulbs have a value of Ra>80, while excellent LED bulbs have a value of Ra>90.

TRIAC Dimming

Controlling the brightness of an LED using a ballast by modulating the 230 V input voltage.



The definition according to the IEC/EN 61347 standard for control gear for electric light sources refers to the temperature measured by the manufacturer that may occur on the case (at the marked location, if applicable) under normal operating conditions.



The maximum permissible ambient temperature for the equipment.



DALI (Digital Addressable Lighting Interface) is a digital protocol for controlling lighting control gear, such as switching power adapters or electronic output dimmers.

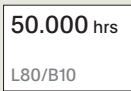

The LM 80 IES standard is a standard for measuring the decline in luminous flux in LED light sources. This specifies the time (50.000 hours) after which the LED still achieves at least 80% of its initial brightness, with 10% of LEDs being less bright (B10).



Luminaires with this marking may be covered with thermal insulation materials.

CASAMBI

Ballasts or light sources that can be controlled via Bluetooth using the Casambi app.

UGR (Unified Glare Rating)

The unified glare rating (UGR) is a method for evaluating glare in indoor spaces. The lower the UGR value, the lower the perceived glare. For office workstations, the UGR value should be <19.



Products with this label are suitable for installation in and on furnishings like furniture. The products may be mounted in furnishings made of materials with unknown fire behavior, even if these are coated, painted, or veneered.

IP65

Ingress Protection (IP)

The IP code indicates how well active parts are protected against touching, the ingress of foreign objects or water by means of the design of an electrical device.

Our example shows IP65 according to DIN EN 60529:

No protection	0	0	No protection
Protection against access with any large surface of the body, such as the back of a hand (diameter > 50 mm)	1	1	Protection against dripping water (vertically falling drops)
Protection against access with a finger (diameter > 12,5 mm)	2	2	Protection against dripping water when tilted at up to 15°
Protection against access with a tool (diameter > 2,5 mm)	3	3	Protection against spraying water, at any angle up to 60° from the vertical
Protection against access with a wire (diameter > 1 mm)	4	4	Protection against splashing of water from any direction
Full protection against touching (against dust in harmful amounts)	5	5	Protection against water jets (nozzle) from any direction
Full protection against touching (dust-tight)	6	6	Protection against powerful water jets
		7	Protection against temporary immersion
		8	Protection against continuous immersion up to 1 m depth
		9	Protection against powerful high-temperature water jets

IK Protection – Impact Protection Ratings

The IK rating (impact protection) refers to the degrees of protection provided by enclosures of electrical equipment against external mechanical impacts according to IEC 60068-2-75.

EEL: Energy Consumption Labelling

The EU Directive 2019/2015 of the European Commission (March 11, 2019) sets the framework for the energy consumption labelling of light sources. Energy efficiency categories from A to G are assigned depending on the ratio of emitted light and consumption in lm/W, depending on the lighting mode.

At the time of introduction of a new scale for a product group, no appliance should achieve energy efficiency category "A," and the majority of products should achieve energy efficiency category "A" no earlier than 10 years after the scale comes into effect.

η_{TM} (lm/W)

A	210
B	185<210
C	160<185
D	135<160
E	110<135
F	85<110
G	85

Appliance Class

The classification and labeling of electrical appliances with regard to the existing protective and safety measures to prevent electric shocks.



Class I:
All conductive chassis parts are connected to an earth conductor using a green/yellow PE wire.



Class II:
Protects by using double-insulated or reinforced insulation of active parts. These appliances are not connected to electrical earth.



Class III:
Protection using extra-low voltage ($\leq 25V$ AC; 60 V DC). These appliances should only be connected to a separated extra-low voltage (SELV) power source.

General Notes

- With the publication of this catalog, all previous editions become invalid.
- Our invoices are payable within 10 days of the invoice date.
minus 2 % cash discount or within 30 days net.
Shipping within Germany is carried out at our discretion by parcel service, delivery company, or our own truck.
- Within Germany and the EU, we offer free shipping for orders with a net value of 130,00 € or more.
For orders under 130,00 €, we charge a flat rate of 8,00 € for packaging and shipping.
Shipping of packages longer than 200 cm is more expensive.
- Shipping costs for island deliveries to the EU outside of Germany are 24,00 €.
We deliver free of charge for orders over 500,00 €.
- For small orders under 25,00 €, we charge an additional processing fee of 3,00 €.
- If an ordered item with a value of up to 50,00 € is temporarily unavailable, we reserve the right to cancel the order.
In this case, you will have to order it again. We will keep backorders for you for three months. The delivery of missing items for goods worth 50,00 € and more will be free in Germany once the items arrive in our warehouse.
- Outside the EU, we charge shipping costs according to the parcel service plus customs duties.
- For orders with target dates that extend more than four weeks into the future from the order date, we charge 5 % of the invoice amount for each month or part thereof for the storage and provision of the goods.
The contractual partner remains free to prove that the damage was less than this.
- Screwing a lamp into a socket is neither installation nor mounting and is therefore not covered as reimbursable costs.
- All items marked with the  symbol must be disposed of separately, not with the household waste.
The disposal costs are already included in the sales prices. Disposal at recycling centers is therefore free of charge.

General Notes on Our Customization Service

- The customer is responsible for providing correct information on the order form. SIGOR provides information necessary for planning, e.g. separable length or strip width, in the catalogue. Complaints regarding incorrect aluminum profile lengths, angles, or unlit areas in the aluminum profile due to limitations caused by the separability of light strips do not constitute grounds for complaint.
- Strips that are not marked as "customizable" can be shortened according to the customer's wishes.
In these cases, we will charge you for and deliver the cutoffs.
- Outdoor cables can be customized and provided with IP protection as long as the necessary protective add-ons can be accommodated in the object, in particular cast resin sleeves and similar items.

Warranty Conditions

The warranty only applies to consumers. The warranty only applies to products purchased in Germany. The warranty period begins on the invoice date. Under this warranty, if material or manufacturing defects that impair the function of the product become apparent during this period, we will provide you with a new, defect-free product. It does not apply to battery capacity faults.

Please contact us as the guarantor in case of claims under this warranty:

SIGOR Licht GmbH
Eichenhofer Weg 81
42279 Wuppertal, Germany

Phone +49 2339 1261-0
reklamation@sigor.de

Warranty claims are voided in the event of damage to the goods due to normal wear and tear and/or improper or unintended use or handling. In order to claim warranty service, you must enable us to examine the warranty claim (e.g., by sending the goods back). If you send the goods in for this purpose, please ensure that the goods are properly packaged to prevent damage during transport. Add a copy of the invoice to the shipment of goods so that we can check whether the warranty period has been observed.

Alternatively, you can send the invoice copy via e-mail to us. If we cannot determine whether the warranty period has expired, we reserve the right to refuse warranty service. If your warranty claims are justified, we will reimburse you for the shipping costs of defect goods and pay the cost for shipping the new, defect-free product to you.

Important Note: This warranty does not limit your legal rights. The warranty is separate from any warranty rights to which you are entitled by law, which you can claim free of charge.

This is an excerpt of our Terms and Conditions.
For the full version of our Terms and Conditions, see www.sigor.de/agb

Image rights: www.sigor.de/quellenhinweise
09/2025 All rights reserved, subject to change.

SIGOR

SIGOR Licht GmbH

Eichenhofer Weg 81
42279 Wuppertal
Germany

Phone +49 2339 1261-0
Fax +49 2339 1261-61

info@sigor.de
www.sigor.de



Catalogue 2025 | 2026

